



# VM3011 Coupon PCB User Guide

Rev 0.1  
By R. Condorelli

## General Description

This document describes the S-VM3011-C Coupon PCB evaluation board. The coupon PCB provides a quick and simple way of evaluating the VM3011, a Pulse Density Modulation (PDM) digital output microphone with Adaptive Zero Power Listening. The board consists of a VM3011 bottom port MEMS microphone and a 0.1uF power supply bypass capacitor along with an edge connector. The user can simply use a corresponding female connector (CW Industries CWR-170-10-0000) or solder wires to make good electrical contact to the power and output pins of the microphone.

## Pinout and Pin Descriptions

The board is shown in Figure 1 as follows and the corresponding pins in Table 1 have been labeled:

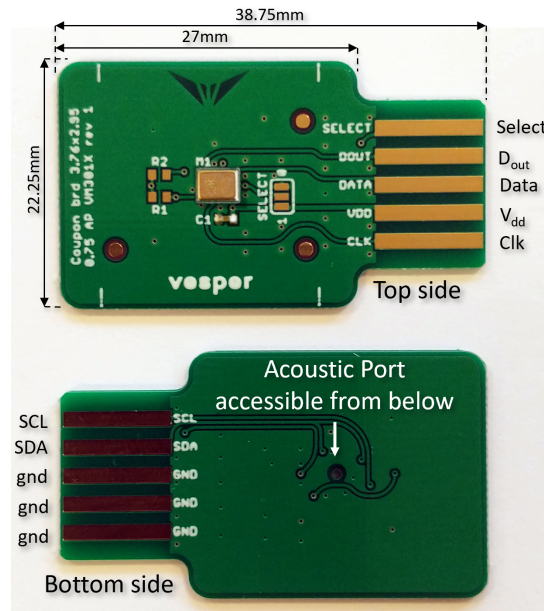

Figure 1. VM3011 Coupon PCB

| Pin Name | Description   |
|----------|---|
| SELECT   | Left/Right Channel Select<br>(High=Left, Low=Right) |
| DOUT     | ZPL Flag pin  |
| DATA     | PDM Digital Output                                  |
| VDD      | Power Supply (1.6-3.6V)                             |
| CLK      | Clock (2.4MHz typical)                              |
| SCL      | I <sup>2</sup> C Bus, clock pin                     |
| SDA      | I <sup>2</sup> C Bus, data pin                      |
| GND      | Ground  |

Table 1: Pinout Configuration

## Edge Connector

VM3011 Coupon PCB can be used with an Edge connector from CW Industries with part number CWR-170-10-0000 as shown in Figure 2. Supply range for V<sub>dd</sub> is 1.6V – 3.6V.

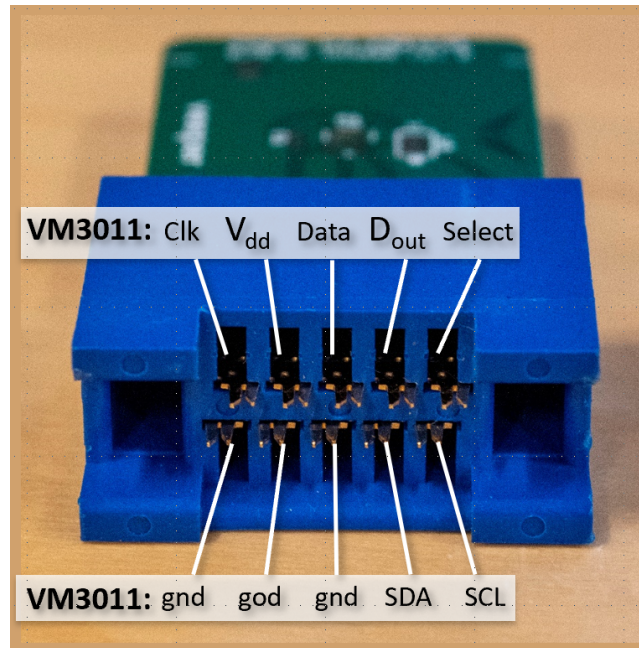
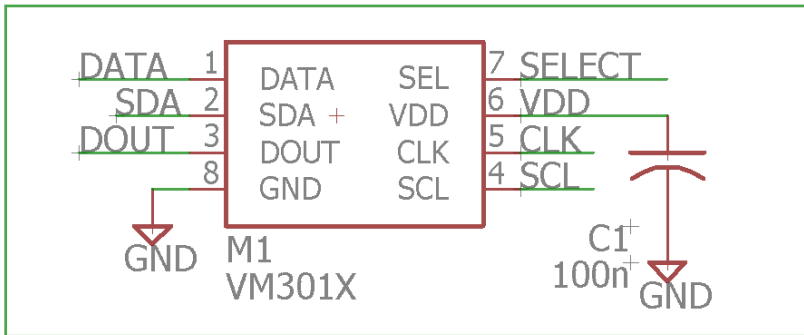

Figure 2: Connections on VM3011 Coupon PCB and Edge Connector CWR-170-10-0000

## Schematic

The schematic of the board and the PCB layout is shown in Figure 3 and Figure 4 respectively.

### Mic



### LR select

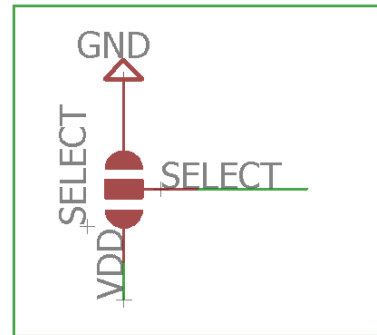

### Edge connector

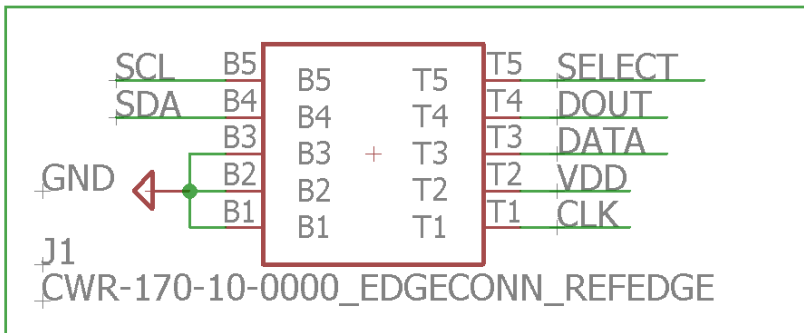

### I2C pull-up res

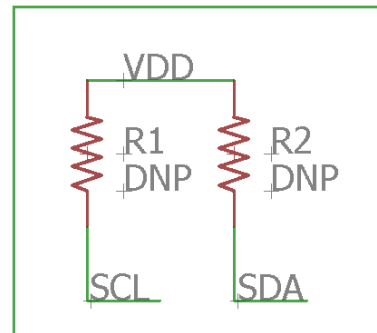

Figure 3. S-VM3011-C Coupon PCB Schematic

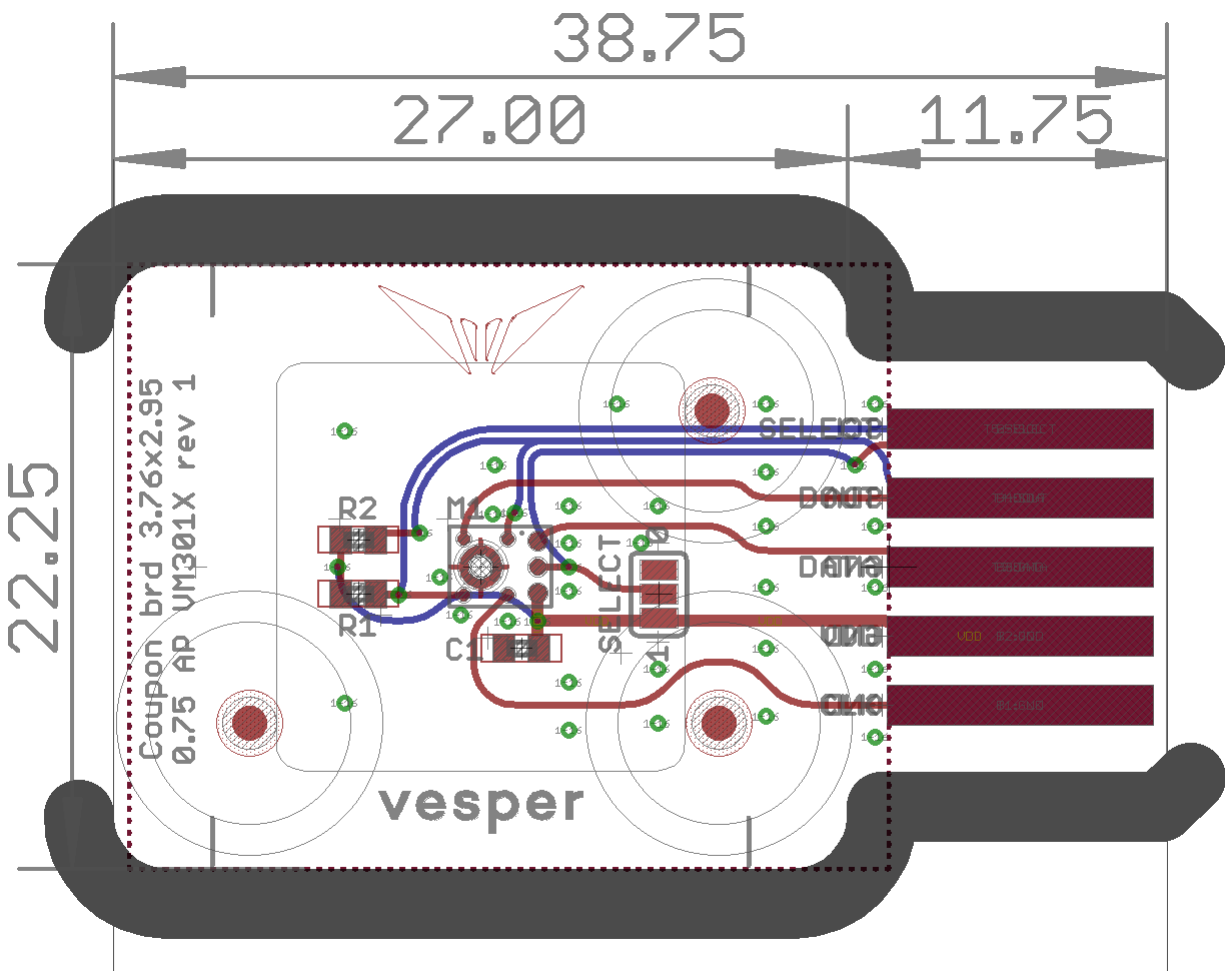

Figure 4. S-VM3011-C Coupon PCB Board Layout (all dimensions in mm)

## Other Information

The detailed specifications and description of the VM3011 microphone can be found in the product datasheet. For convenience, the basic parameters and absolute maximum ratings also shown in Table 2 and 3 below:

| Parameter   | Typical Value | Units |
|---|---------------|-------|
| Supply Voltage  | 1.8           | V     |
| Sensitivity @ 94dB SPL                                  | -26.0 +/- 1   | doffs |
| Output DC Offset  | 0.05          | dBFS  |
| Supply current – Zero-Power Listening (VDD On, CLK Off) | 10            | μA    |
| Supply current – standby mode (VDD On, CLK <250KHz)     | 98            | μA    |
| Supply current – Low Power mode (CLK = 768 MHz)         | 350           | μA    |
| Supply current – Normal mode (CLK = 2.4 MHz)            | 635           | μA    |

Table 2. Typical parameters for microphone operation

| Parameter                   | Rating       | Units        |
|-----------------------------|--------------|--------------|
| Supply Voltage              | -0.3 to +3.6 | V            |
| Sound Pressure Level        | 160          | dB re 20 μPa |
| Operating Temperature Range | -40 to +85   | °C           |
| Storage Temperature Range   | -55 to +150  | °C           |

Table 3. Absolute Maximum Ratings

For additional information on Vesper’s latest roadmap of microphone products, reach out to [sales@vespermems.com](mailto:sales@vespermems.com).