

ILS Series Integrated LED Tact Switch

NEW

Features/Benefits

- Compact Size
- THT versions
- Different height
- Several LED colors
- High life cycles

Typical Applications

- Consumer electronics
- Health monitoring device
- Test & measurement
- Audio/Video control board

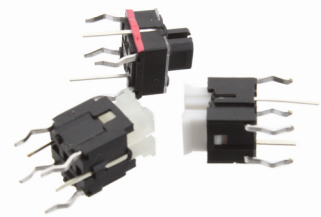

Specification

TRAVEL: 0.25 mm ± 0.1 mm

Mechanical

OPERATING LIFE: 100,000 cycles

Electrical

RATING: 100mA max. @ 30VDC
10µA min. @ 1VDC

INSULATION RESISTANCE: 100M Ω min.

DIELECTRIC WITHSTANDING VOLTAGE:

250VAC (50-60 Hz 2mA) for 1 min

BOUNCE TIME: ON/OFF 5ms max.

INITIAL CONTACT RESISTANCE: 100m Ω max.

Environmental

OPERATING TEMPERATURE: -40°C to +85°C

STORAGE TEMPERATURE: -40°C to +85°C

Packaging

Bulk packing in bag of 500 pieces

2 bags per carton box

* All caps are not recommended to soldering process

How To Order

Our easy build-a-switch concept allows you to mix and match options to create the switch you need. To order, select desired option from each category and place it in the appropriate box.

For any part number different from those listed above, please consult your local representative.

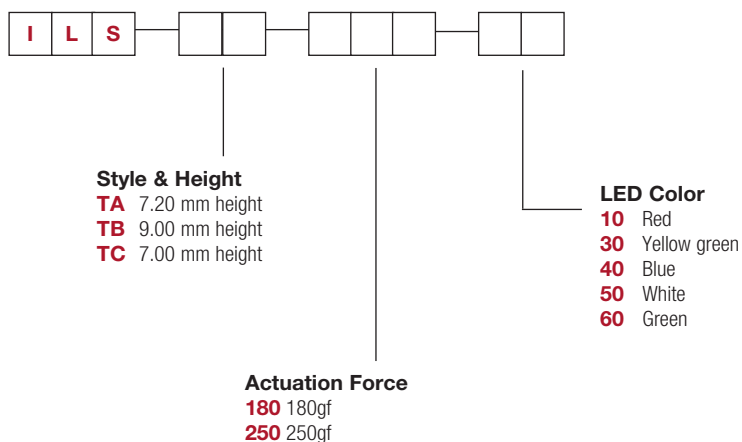

Dimensions are shown: mm
Specifications and dimensions subject to change

NEW

ILS Series Integrated LED Tact Switch

LED CHARACTERISTICS

STANDARD LED COLOR OPTIONS

LED Parameter	Symbol	Condition	UNITS	RED 10	YELLOW/GREEN 30	BLUE 40	WHITE 50	GREEN 60
Power Dissipation	Pd	-	mW	52	60	120	18	120
Forward Current	IF	-	mA	20	20	30	5	30
Peak Forward Current *1	IFP	-	mA	100	100	100	100	100
Reverse Voltage	VR	-	V	5	5	5	5	5
Operating Temperature	ToPr	-	-	-40°C to 85°C	-40°C to 85°C	-40°C to 85°C	-40°C to 85°C	-40°C to 85°C
Storage Temperature	Tstg	-	-	-40°C to 85°C	-40°C to 85°C	-40°C to 85°C	-40°C to 85°C	-40°C to 85°C
Forward Voltage	Vf	F=5mA	V	2.6 max.	2.3 max.	3.2 max.	3.6 max.	3.4 max.
Luminous Intensity	Iv	F=5mA	mcd	140 min.	100 min.	63 min.	94 min.	1000 min.
Reverse Current	IR	F=5mA	μA	100 max.	-	-	1 max.	-
Peak Wave Length	λp	F=5mA	nm	644	570	460	-	521.5
Dominant Wave Length	λd	F=5mA	nm	620 min.	567-573	465-470	-	515-525
Spectral Line Half-width	Δλ	F=5mA	nm	20	30	30	-	30
Viewing Angle	2θ1/2	F=5mA	deg	35	35	35	35	35

STYLES

TA

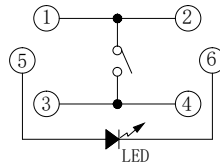
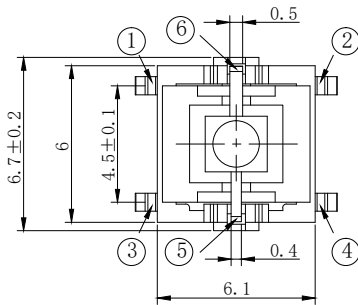

CIRCUIT DIAGRAM

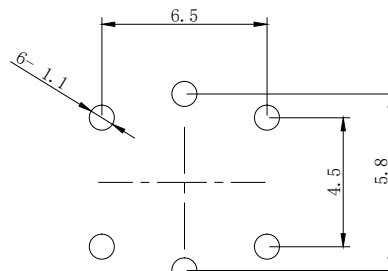
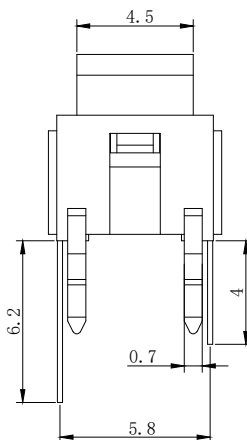
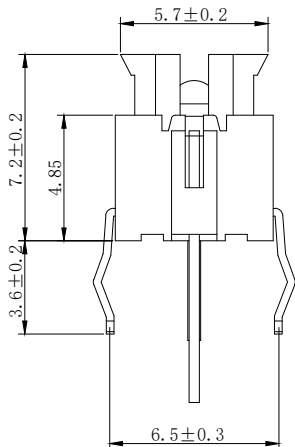

P.C.B LAND DIMENSION

ILS Series Integrated LED Tact Switch

NEW

STYLES

TB

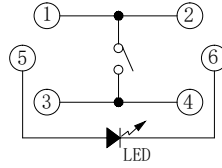
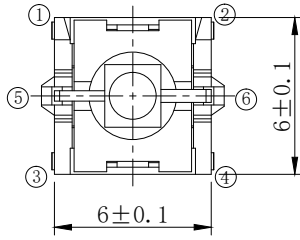

CIRCUIT DIAGRAM

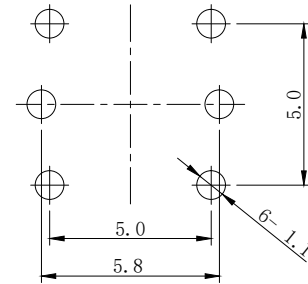
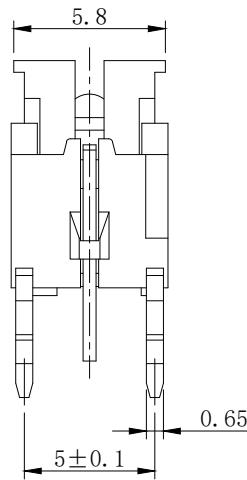
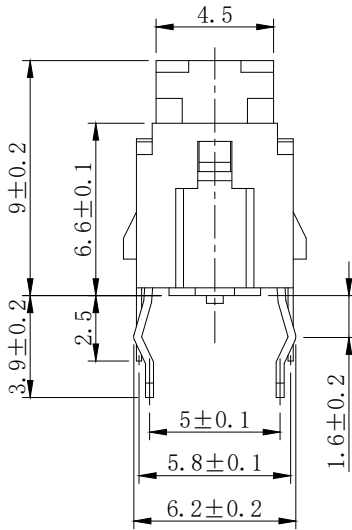

P.C.B LAND DIMENSION

TC

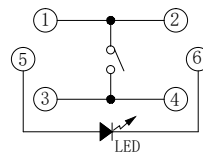
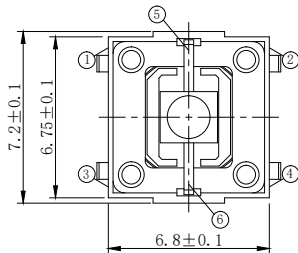

CIRCUIT DIAGRAM

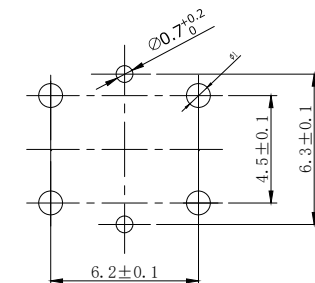
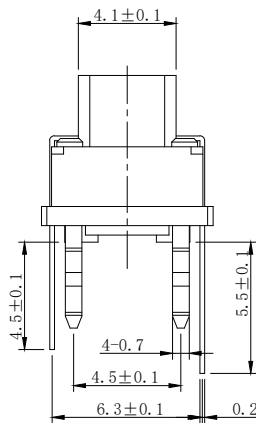
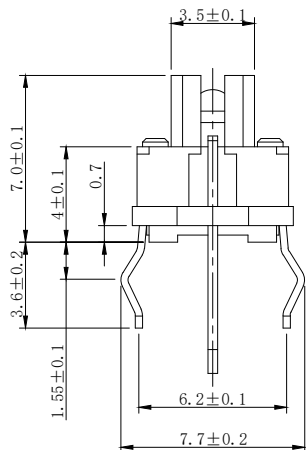

P.C.B LAND DIMENSION



NEW

ILS Series Integrated LED Tact Switch

CAPS

Tactile Switches

B

ILSCAPR0690-10

Round cap, grey with power logo

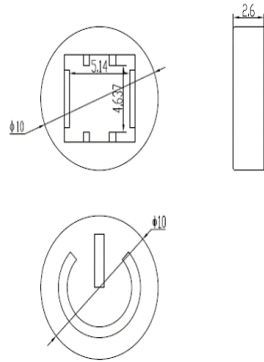

ILSCAPS757501

Square cap with hole

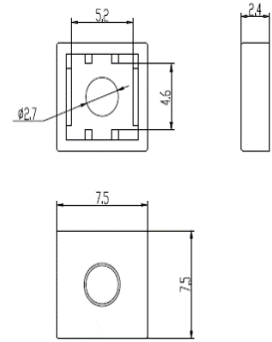

ILSCAPS757502 (Nature) ILSCAPS757503 (Grey)

Square cap without hole

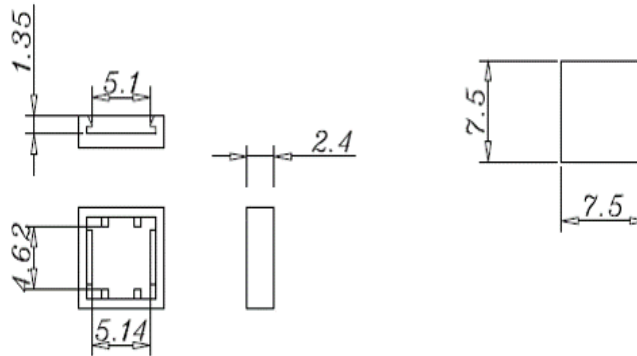
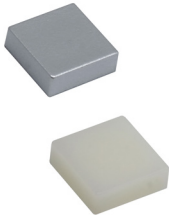

ILSCAPR0690-10B

Round cap, black with power logo

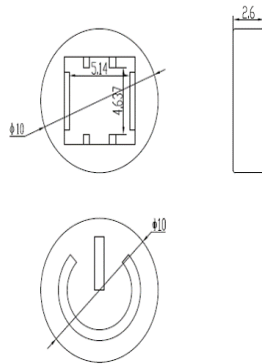

ILSCAPR0690

Round cap, grey with power logo

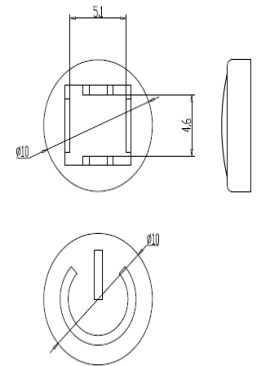

ILSCAPR0691

Round cap, without power logo

