

Low drop power Schottky rectifier

Datasheet - production data

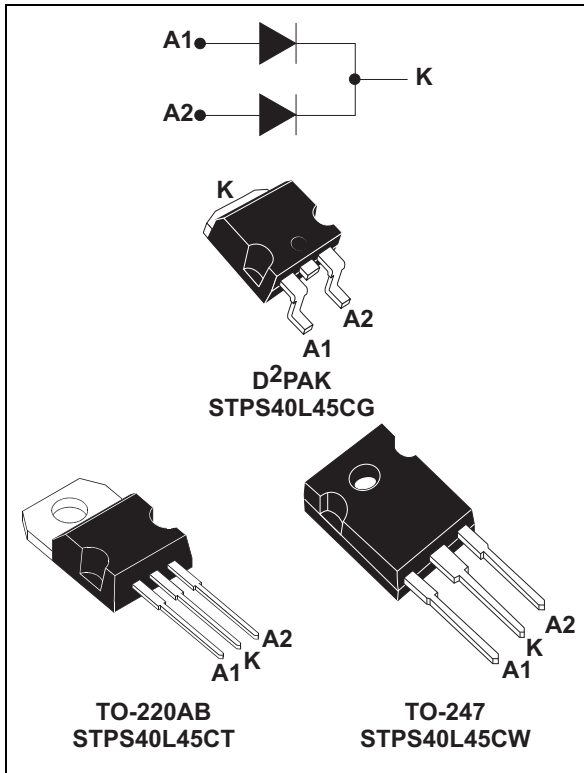

Description

Dual center tap Schottky barrier rectifier designed for high frequency switched mode power supplies and DC to DC converters.

Packaged in TO-220AB, TO-247 and D²PAK these devices are intended for use in low voltage, high frequency inverters, free-wheeling and polarity protection applications.

Table 1. Device summary

$I_{F(AV)}$	2 x 20 A
V_{RRM}	45 V
$T_j(\text{max})$	150° C
$V_F(\text{max})$	0.49 V

Features

- Low forward voltage drop meaning very small conduction losses
- Low switching losses allowing high frequency operation
- Avalanche capability specified

1 Characteristics

Table 2. Absolute Ratings (limiting values, per diode)

Symbol	Parameter		Value	Unit
V _{RRM}	Repetitive peak reverse voltage		45	V
I _{F(RMS)}	Forward rms current		30	A
I _{F(AV)}	Average forward current	T _c = 130° C δ = 0.5	Per diode 40 Per device	A
I _{FSM}	Surge non repetitive forward current	t _p = 10 ms Sinusoidal	220	A
I _{RRM}	Repetitive peak reverse current	t _p = 2 μs square F = 1 kHz	2	A
I _{RSM}	Non repetitive peak reverse current	t _p = 100 μs square	3	A
P _{ARM}	Repetitive peak avalanche power	t _p = 1 μs T _j = 25° C	8100	W
T _{stg}	Storage temperature range		-65 to + 150	°C
T _j	Maximum operating junction temperature ⁽¹⁾		150	°C
dV/dt	Critical rate of rise of reverse voltage		10000	V/μs

1. $\frac{dP_{tot}}{dT_j} < \frac{1}{R_{th(j-a)}}$ condition to avoid thermal runaway for a diode on its own heatsink

Table 3. Thermal resistances

Symbol	Parameter		Value	Unit
R _{th(j-c)}	Junction to case	Per diode	1.5	°C/W
		Total	0.8	
R _{th(c)}	Coupling		0.1	°C/W

When the diodes 1 and 2 are used simultaneously:

$$\Delta T_j(\text{diode 1}) = P(\text{diode1}) \times R_{th(j-c)}(\text{Per diode}) + P(\text{diode2}) \times R_{th(c)}$$

Table 4. Static electrical characteristics (per diode)

Symbol	Parameter	Test Conditions		Min.	Typ.	Max.	Unit
I _R ⁽¹⁾	Reverse leakage current	T _j = 25° C	V _R = V _{RRM}			0.6	mA
		T _j = 125° C			140	280	
V _F ⁽¹⁾	Forward voltage drop	T _j = 25° C	I _F = 20 A			0.53	V
		T _j = 125° C	I _F = 20 A		0.42	0.49	
		T _j = 25° C	I _F = 40 A			0.69	
		T _j = 125° C	I _F = 40 A		0.6	0.7	

1. Pulse test: t_p = 380 μs, δ < 2%

To evaluate the conduction losses use the following equation:

$$P = 0.28 \times I_{F(AV)} + 0.0105 I_{F(RMS)}^2$$

Figure 1. Average forward power dissipation versus average forward current (per diode)

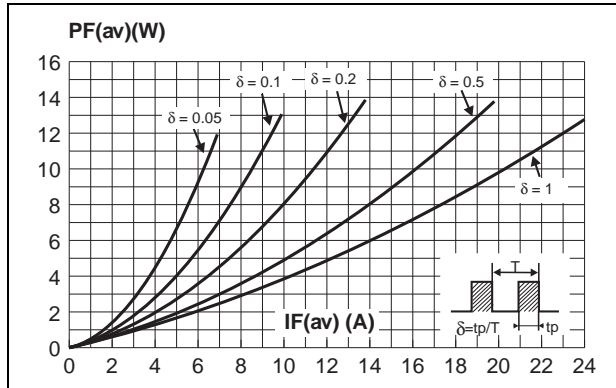

Figure 2. Average forward current versus ambient temperature ($\delta = 0.5$, per diode)

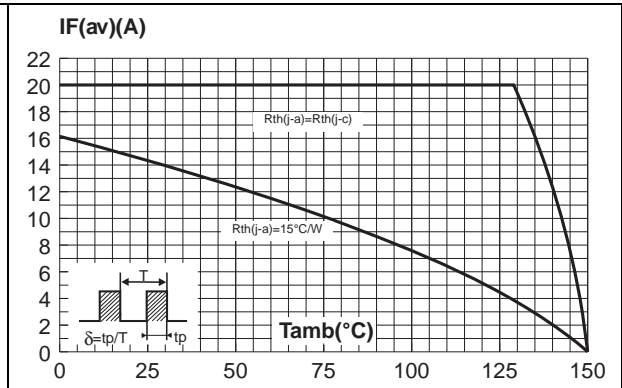

Figure 3. Normalized avalanche power derating versus pulse duration

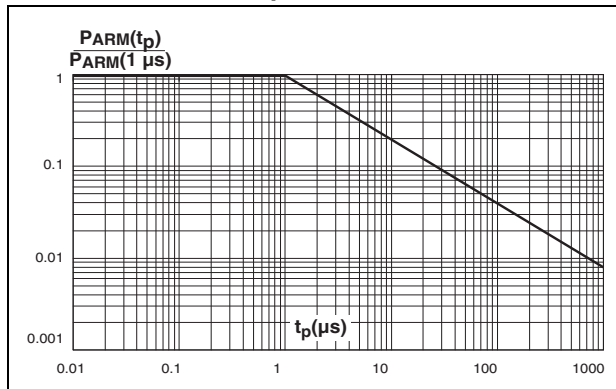

Figure 4. Normalized avalanche power derating versus junction temperature

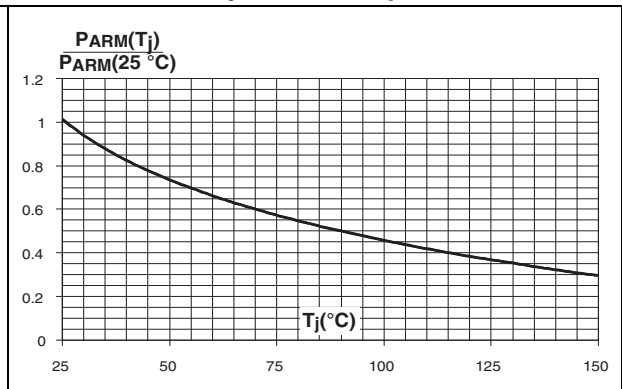

Figure 5. Non repetitive surge peak forward current versus overload duration (maximum values, per diode)

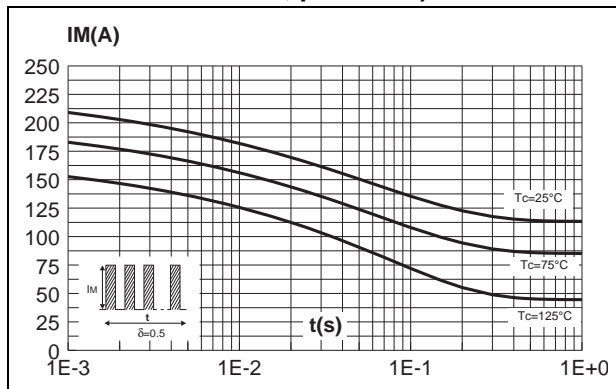

Figure 6. Relative variation of thermal impedance junction to case versus pulse duration

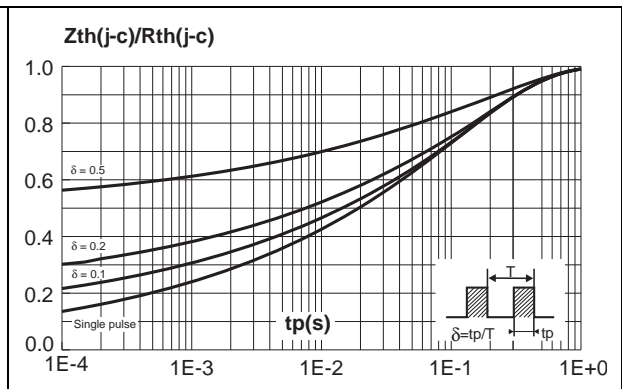

Figure 7. Reverse leakage current versus reverse voltage applied (typical values, per diode)

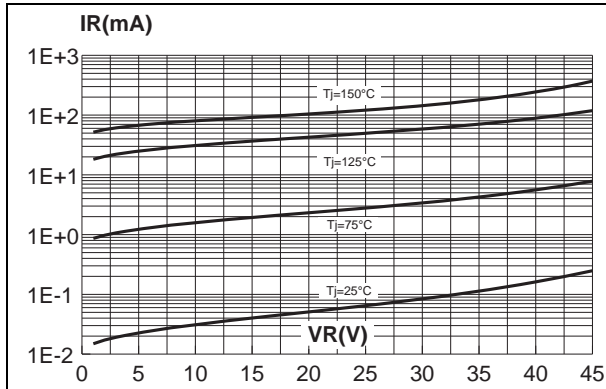

Figure 8. Junction capacitance versus reverse voltage applied (typical values, per diode)

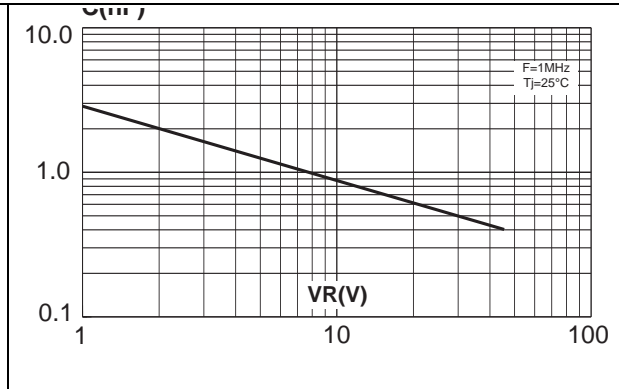

Figure 9. Forward voltage drop versus forward current (maximum values, per diode)

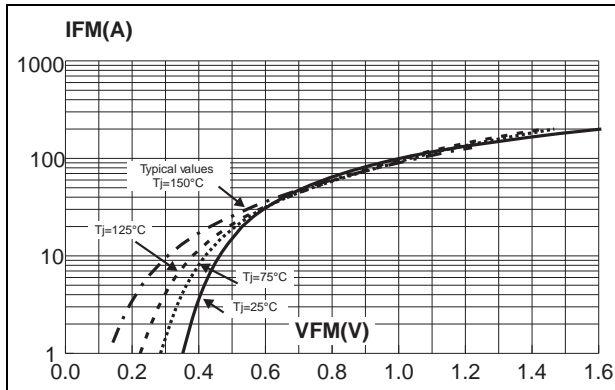

Figure 10. Thermal resistance junction to ambient versus copper surface under tab

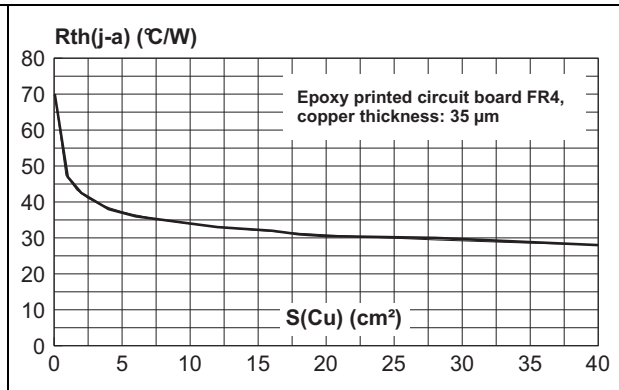

Table 5. TO-220AB dimension values

Ref.	Dimensions			
	Millimeters		Inches	
	Min.	Max.	Min.	Max.
A	4.40	4.60	0.17	0.18
b	0.61	0.88	0.024	0.035
b1	1.14	1.70	0.045	0.067
c	0.48	0.70	0.019	0.027
D	15.25	15.75	0.60	0.62
D1	1.27 typ.		0.05 typ.	
E	10	10.40	0.39	0.41
e	2.40	2.70	0.094	0.106
e1	4.95	5.15	0.19	0.20
F	1.23	1.32	0.048	0.052
H1	6.20	6.60	0.24	0.26
J1	2.40	2.72	0.094	0.107
L	13	14	0.51	0.55
L1	3.50	3.93	0.137	0.154
L20	16.40 typ.		0.64 typ.	
L30	28.90 typ.		1.13 typ.	
ØP	3.75	3.85	0.147	0.151
Q	2.65	2.95	0.104	0.116

Figure 12. D²PAK dimension definitions

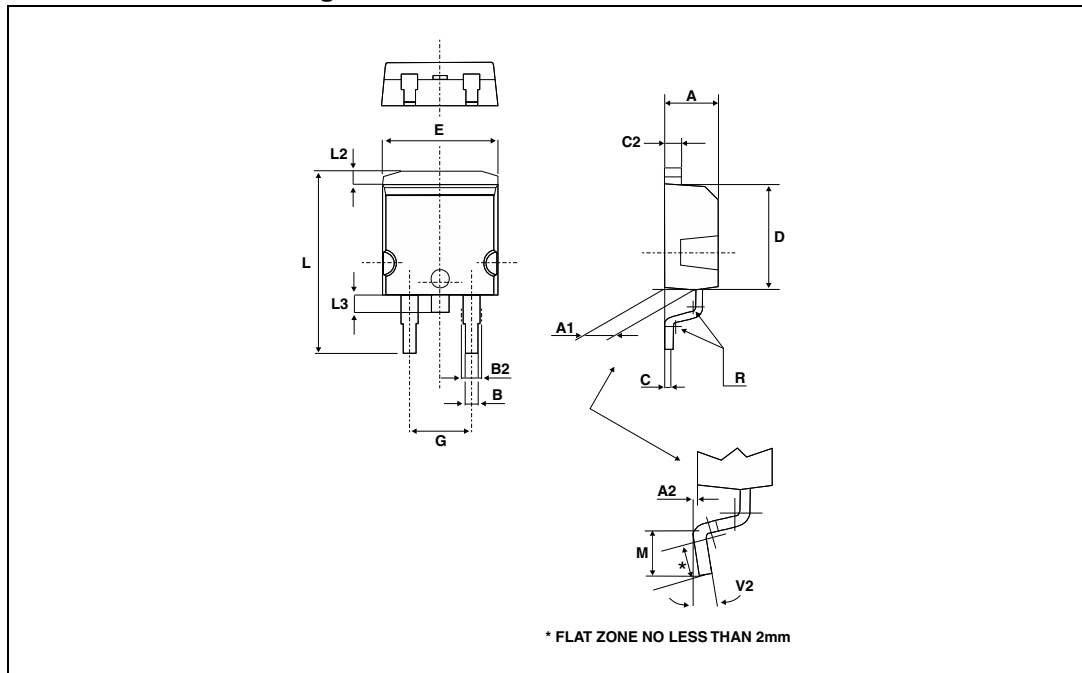

Table 6. D²PAK dimension values

Ref.	Dimensions			
	Millimeters		Inches	
	Min.	Max.	Min.	Max.
A	4.40	4.60	0.173	0.181
A1	2.49	2.69	0.098	0.106
A2	0.03	0.23	0.001	0.009
B	0.70	0.93	0.027	0.037
B2	1.14	1.70	0.045	0.067
C	0.45	0.60	0.017	0.024
C2	1.23	1.36	0.048	0.054
D	8.95	9.35	0.352	0.368
E	10.00	10.40	0.393	0.409
G	4.88	5.28	0.192	0.208
L	15.00	15.85	0.590	0.624
L2	1.27	1.40	0.050	0.055
L3	1.30	1.75	0.051	0.069
M	2.29	2.79	0.090	0.110
R	0.40 typ.		0.016 typ.	
V2	0°	8°	0°	8°

Figure 13. D²PAK footprint (dimensions in mm)

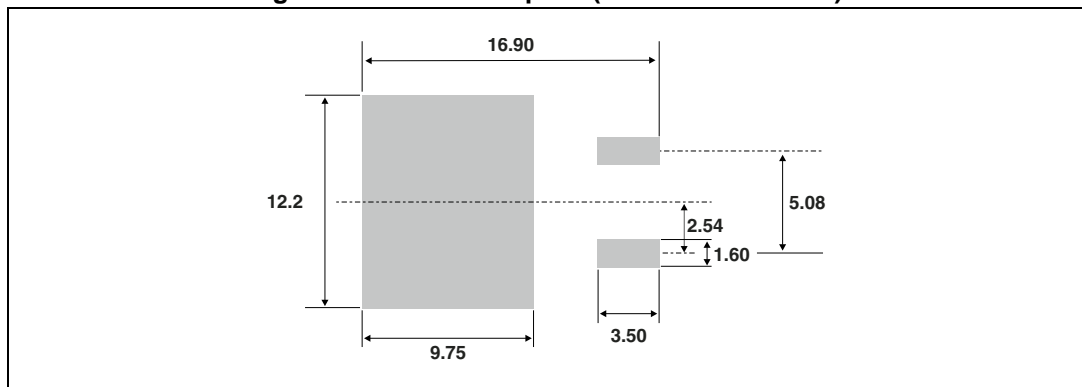

Figure 14. TO-247 dimension definitions

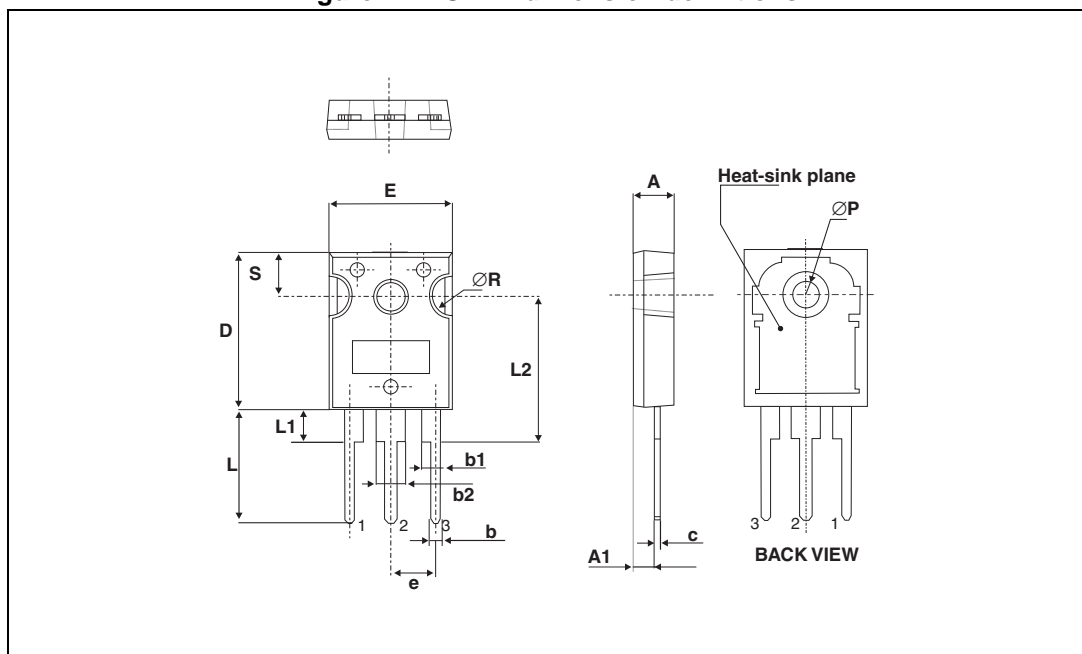

Table 7. TO-247 dimension values

Ref.	Dimensions					
	Millimeters			Inches		
	Min.	Typ.	Max.	Min.	Typ	Max.
A	4.85		5.15	0.191		0.203
A1	2.20		2.60	0.086		0.102
b	1.00		1.40	0.039		0.055
b1	2.00		2.40	0.078		0.094
b2	3.00		3.40	0.118		0.133
c	0.40		0.80	0.015		0.031
D ⁽¹⁾	19.85		20.15	0.781		0.793
E	15.45		15.75	0.608		0.620
e	5.30	5.45	5.60	0.209	0.215	0.220
L	14.20		14.80	0.559		0.582
L1	3.70		4.30	0.145		0.169
L2	18.50 typ.			0.728 typ.		
∅P ⁽²⁾	3.55		3.65	0.139		0.143
∅R	4.50		5.50	0.177		0.217
S	5.30	5.50	5.70	0.209	0.216	0.224

1. Dimension D plus gate protrusion does not exceed 20.5 mm
2. Resin thickness around the mounting hole is not less than 0.9 mm

3 Ordering Information

Table 8. Ordering information

Order code	Marking	Package	Weight	Base qty	Delivery mode
STPS40L45CG	STPS40L45CG	D ² PAK	1.8g	500	Tape and reel
STPS40L45CT	STPS40L45CT	TO-220AB	2g	50	Tube
STPS40L45CW	STPS40L45CW	TO-247	4.4g	30	Tube

4 Revision history

Table 9. Document revision history

Date	Revision	Description of Changes
Jul-2003	4A	Previous version
30-Oct-2013	5	Updated Package information section

Please Read Carefully:

Information in this document is provided solely in connection with ST products. STMicroelectronics NV and its subsidiaries ("ST") reserve the right to make changes, corrections, modifications or improvements, to this document, and the products and services described herein at any time, without notice.

All ST products are sold pursuant to ST's terms and conditions of sale.

Purchasers are solely responsible for the choice, selection and use of the ST products and services described herein, and ST assumes no liability whatsoever relating to the choice, selection or use of the ST products and services described herein.

No license, express or implied, by estoppel or otherwise, to any intellectual property rights is granted under this document. If any part of this document refers to any third party products or services it shall not be deemed a license grant by ST for the use of such third party products or services, or any intellectual property contained therein or considered as a warranty covering the use in any manner whatsoever of such third party products or services or any intellectual property contained therein.

UNLESS OTHERWISE SET FORTH IN ST'S TERMS AND CONDITIONS OF SALE ST DISCLAIMS ANY EXPRESS OR IMPLIED WARRANTY WITH RESPECT TO THE USE AND/OR SALE OF ST PRODUCTS INCLUDING WITHOUT LIMITATION IMPLIED WARRANTIES OF MERCHANTABILITY, FITNESS FOR A PARTICULAR PURPOSE (AND THEIR EQUIVALENTS UNDER THE LAWS OF ANY JURISDICTION), OR INFRINGEMENT OF ANY PATENT, COPYRIGHT OR OTHER INTELLECTUAL PROPERTY RIGHT.

ST PRODUCTS ARE NOT DESIGNED OR AUTHORIZED FOR USE IN: (A) SAFETY CRITICAL APPLICATIONS SUCH AS LIFE SUPPORTING, ACTIVE IMPLANTED DEVICES OR SYSTEMS WITH PRODUCT FUNCTIONAL SAFETY REQUIREMENTS; (B) AERONAUTIC APPLICATIONS; (C) AUTOMOTIVE APPLICATIONS OR ENVIRONMENTS, AND/OR (D) AEROSPACE APPLICATIONS OR ENVIRONMENTS. WHERE ST PRODUCTS ARE NOT DESIGNED FOR SUCH USE, THE PURCHASER SHALL USE PRODUCTS AT PURCHASER'S SOLE RISK, EVEN IF ST HAS BEEN INFORMED IN WRITING OF SUCH USAGE, UNLESS A PRODUCT IS EXPRESSLY DESIGNATED BY ST AS BEING INTENDED FOR "AUTOMOTIVE, AUTOMOTIVE SAFETY OR MEDICAL" INDUSTRY DOMAINS ACCORDING TO ST PRODUCT DESIGN SPECIFICATIONS. PRODUCTS FORMALLY ESCC, QML OR JAN QUALIFIED ARE DEEMED SUITABLE FOR USE IN AEROSPACE BY THE CORRESPONDING GOVERNMENTAL AGENCY.

Resale of ST products with provisions different from the statements and/or technical features set forth in this document shall immediately void any warranty granted by ST for the ST product or service described herein and shall not create or extend in any manner whatsoever, any liability of ST.

ST and the ST logo are trademarks or registered trademarks of ST in various countries.

Information in this document supersedes and replaces all information previously supplied.

The ST logo is a registered trademark of STMicroelectronics. All other names are the property of their respective owners.

© 2013 STMicroelectronics - All rights reserved

STMicroelectronics group of companies

Australia - Belgium - Brazil - Canada - China - Czech Republic - Finland - France - Germany - Hong Kong - India - Israel - Italy - Japan - Malaysia - Malta - Morocco - Philippines - Singapore - Spain - Sweden - Switzerland - United Kingdom - United States of America

www.st.com

