

Automotive Turbo 2 ultrafast high voltage rectifier

Datasheet – production data

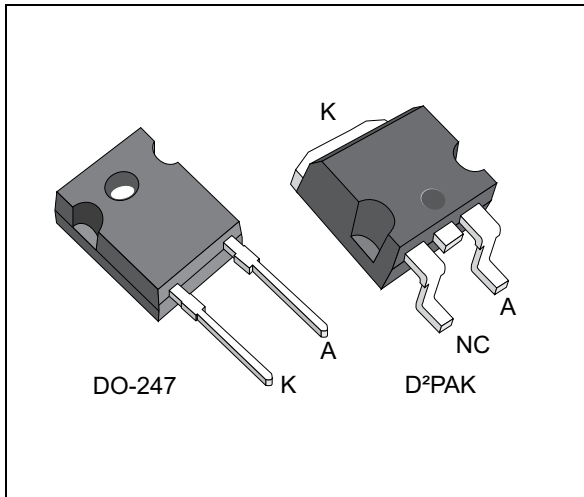

Features

- Aluminum ribbon bonding
- Ultrafast switching
- Low reverse current
- Low thermal resistance
- Reduces switching and conduction losses
- ECOPACK[®]2 compliant component (DO-247)
- AEC-Q101 qualified

Description

The STTH30ST06-Y, which uses ST Turbo 2, 600 V technology, is packaged in DO-247 and D²PAK with aluminum ribbon to ensure a high robustness. It is especially suited for use in switching power supplies and automotive applications, industrial applications, as rectification and boost diode for circuits working in continuous conduction mode.

Table 1. Device summary

Symbol	Value
$I_{F(AV)}$	30 A
V_{RRM}	600 V
t_{rr} (typ)	39 ns
T_j	-40 to +175 °C
V_F (typ)	1.75 V

1 Characteristics

Table 2. Absolute ratings (limiting values, at 25 °C, unless otherwise specified)

Symbol	Parameter	Value	Unit	
V_{RRM}	Repetitive peak reverse voltage	600	V	
V_{RRM}	Repetitive peak reverse voltage, $T_j = -40\text{ °C}$	560	V	
$I_{F(RMS)}$	Forward rms current	64	A	
$I_{F(AV)}$	Average forward current, $\delta = 0.5$	$T_c = 65\text{ °C}$	30	A
I_{FSM}	Surge non repetitive forward current	$t_p = 10\text{ ms sinusoidal}$	160	A
T_{stg}	Storage temperature range	-65 to + 175	°C	
T_j	Maximum operating junction temperature	-40 to + 175	°C	

Table 3. Thermal resistance

Symbol	Parameter	Value	Unit
$R_{th(j-c)}$	Junction to case (DO-247, D ² PAK)	1.25	°C / W

Table 4. Static electrical characteristics

Symbol	Parameter	Test conditions	Min.	Typ	Max.	Unit
$I_R^{(1)}$	Reverse leakage current	$T_j = 25\text{ °C}$			50	μA
		$T_j = 125\text{ °C}$			50	
$V_F^{(2)}$	Forward voltage drop	$T_j = 25\text{ °C}$	$I_F = 30\text{ A}$		3.6	V
		$T_j = 125\text{ °C}$			1.75	

1. Pulse test: $t_p = 5\text{ ms}$, $\delta < 2\%$

2. Pulse test: $t_p = 380\text{ }\mu\text{s}$, $\delta < 2\%$

To evaluate the conduction losses use the following equation:

$$P = 1.45 \times I_{F(AV)} + 0.025 I_{F(RMS)}^2$$

Table 5. Dynamic electrical characteristics

Symbol	Parameter	Test conditions		Min.	Typ	Max.	Unit
I_{RM}	Reverse recovery current	$T_j = 125\text{ }^\circ\text{C}$	$I_F = 30\text{ A}, V_R = 400\text{ V}$ $dI_F/dt = -100\text{ A}/\mu\text{s}$		4	5.5	A
S_{factor}	Softness factor				0.3		
t_{rr}	Reverse recovery time	$T_j = 25\text{ }^\circ\text{C}$	$I_F = 1\text{ A}, V_R = 30\text{ V}$ $dI_F/dt = -50\text{ A}/\mu\text{s}$		39	50	ns
			$I_F = 0.5\text{ A}, I_{rr} = 0.25\text{ A}$ $I_R = 1\text{ A}$			30	
t_{fr}	Forward recovery time		$I_F = 30\text{ A}, V_{FR} = 4\text{ V}$ $dI_F/dt = 300\text{ A}/\mu\text{s}$			200	
V_{FP}	Forward recovery voltage				7		V

Figure 1. Average forward power dissipation versus average forward current

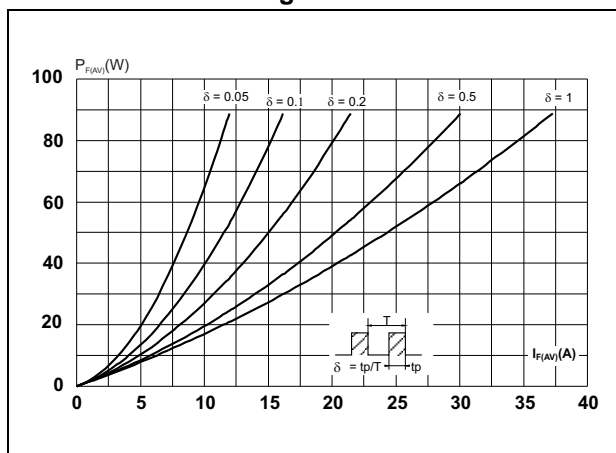

Figure 2. Forward voltage drop versus forward current

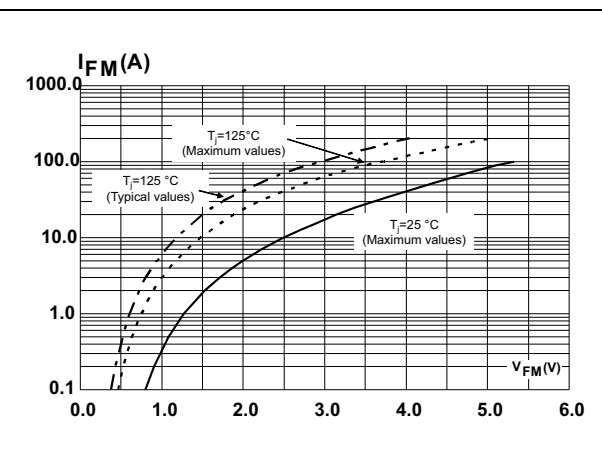

Figure 3. Relative variation of thermal impedance junction to case versus pulse duration

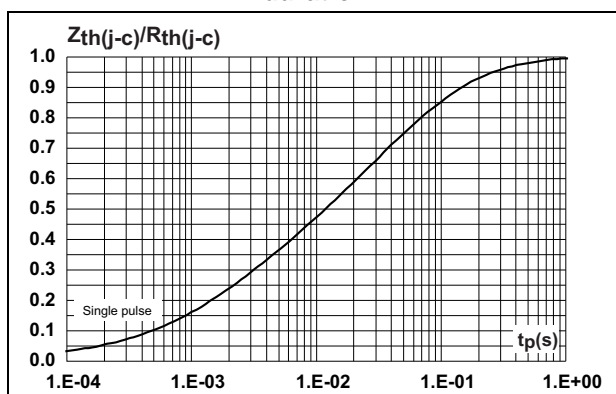

Figure 4. Peak reverse recovery current versus dI_F/dt (typical values)

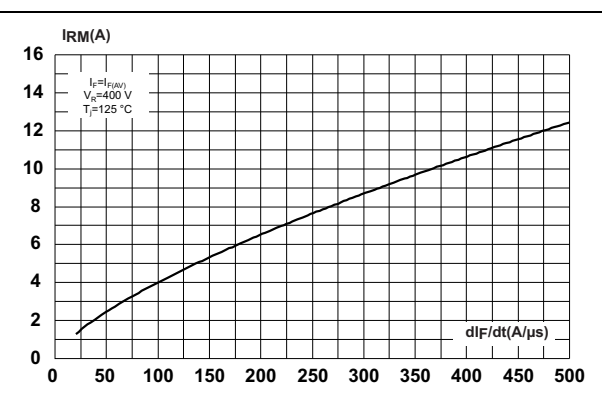

Figure 5. Reverse recovery time versus di_F/dt (typical values)

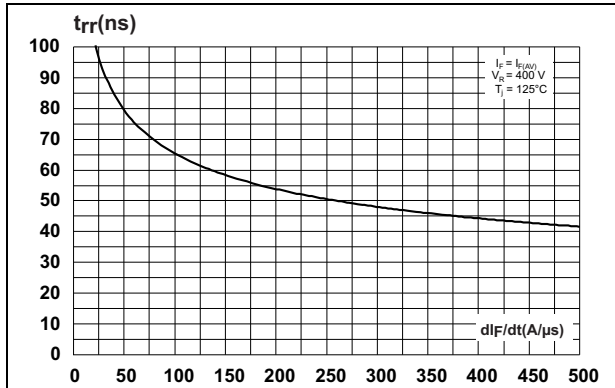

Figure 6. Reverse recovery charges versus di_F/dt (typical values)

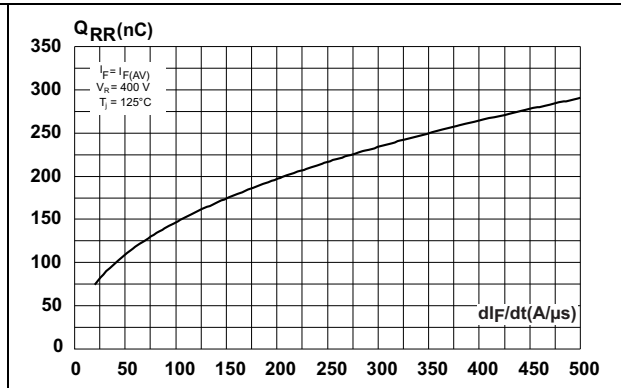

Figure 7. Reverse recovery softness factor versus di_F/dt (typical values)

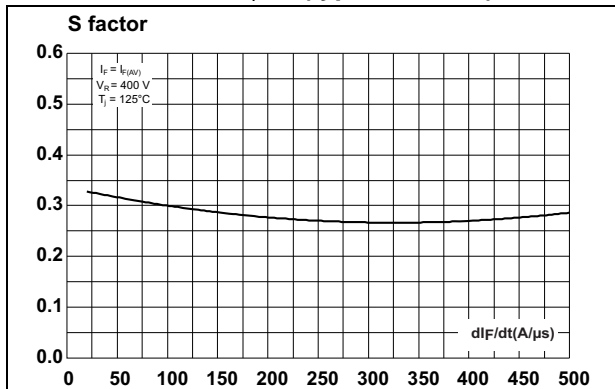

Figure 8. Relative variation of dynamic parameters versus junction temperature

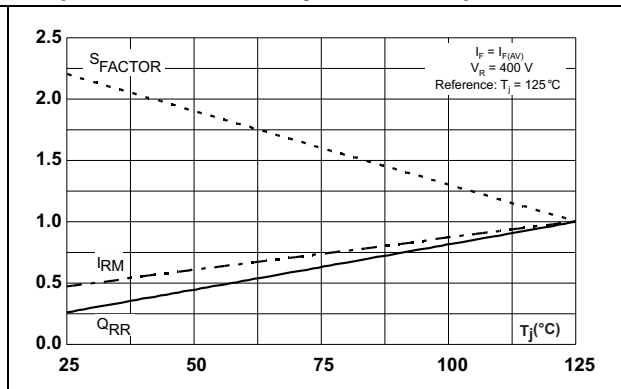

Figure 9. Transient peak forward voltage versus di_F/dt (typical values)

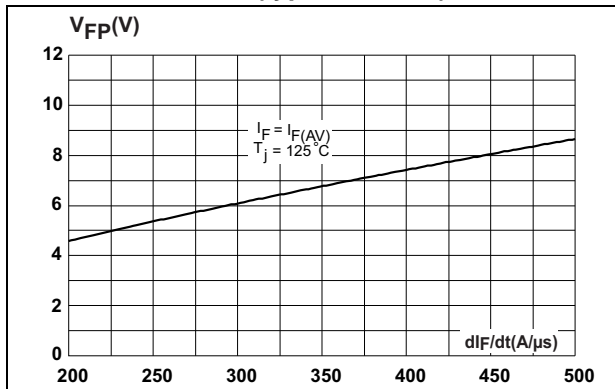

Figure 10. Forward recovery time versus di_F/dt (typical values)

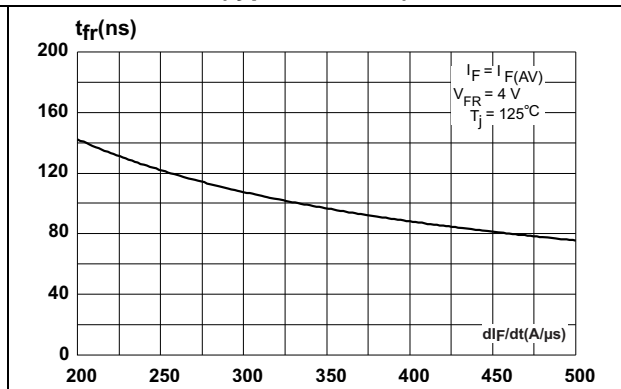
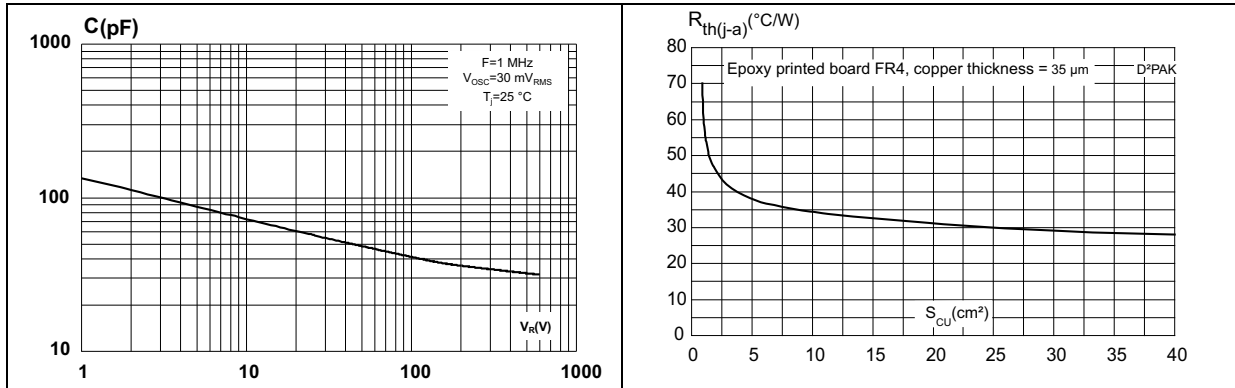

Figure 11. Junction capacitance versus reverse voltage applied (typical values)

Figure 12. Junction capacitance versus reverse voltage applied (typical values)



2 Package information

- Epoxy meets UL94, V0
- Lead-free package
- Cooling method: by conduction (C)
- Recommended torque value: 0.55 N·m (1.0 N·m maximum)

In order to meet environmental requirements, ST offers these devices in different grades of ECOPACK® packages, depending on their level of environmental compliance. ECOPACK® specifications, grade definitions and product status are available at: www.st.com. ECOPACK® is an ST trademark.

Figure 13. D²PAK dimension definitions

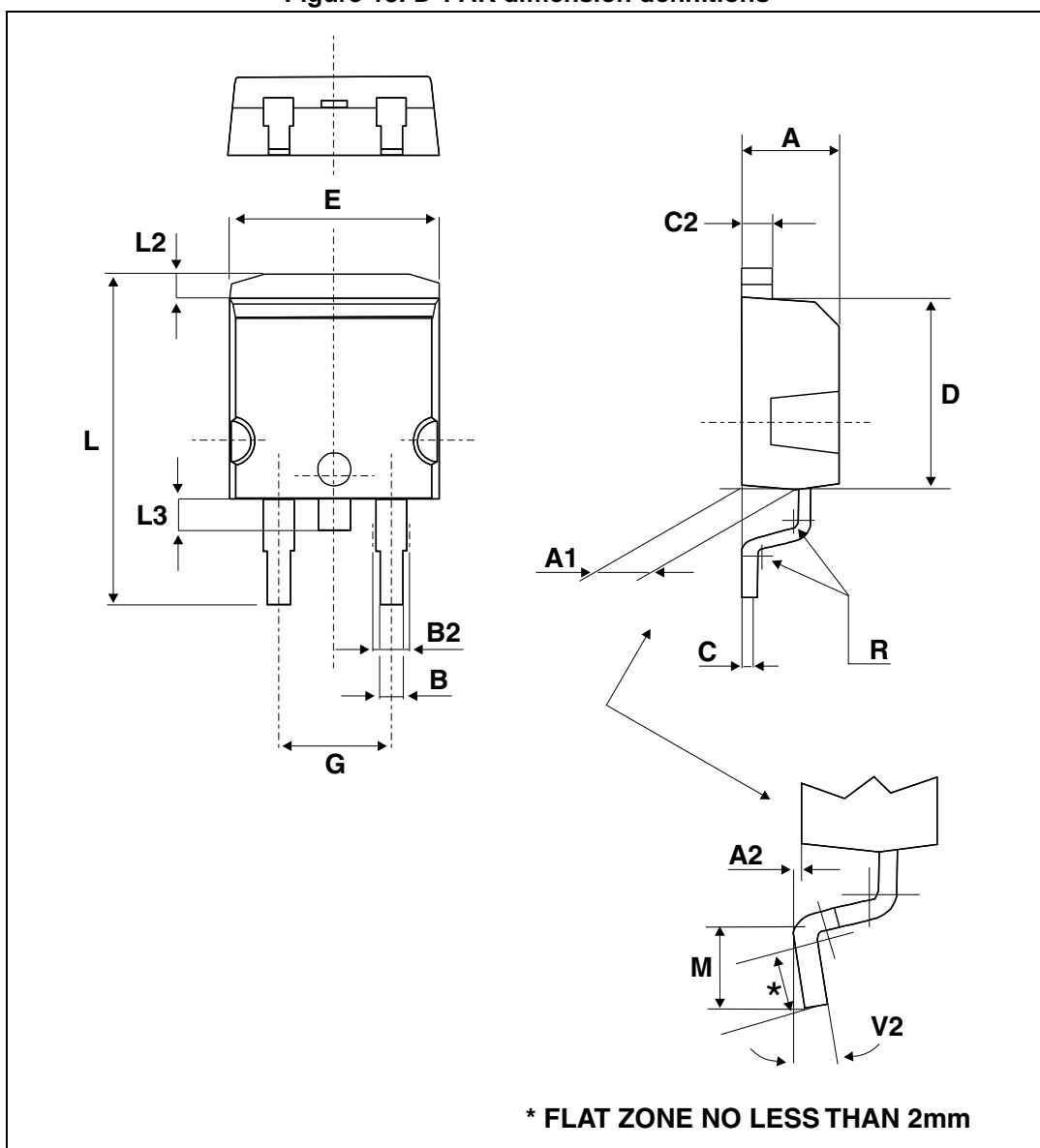

Table 6. D²PAK dimension values

Ref.	Dimensions					
	Millimeters			Inches		
	Min.	Typ.	Max.	Min.	Typ.	Max.
A	4.40		4.60	0.173		0.181
A1	2.49		2.69	0.098		0.106
A2	0.03		0.23	0.001		0.009
B	0.70		0.93	0.027		0.037
B2	1.14		1.70	0.045		0.067
C	0.45		0.60	0.017		0.024
C2	1.23		1.36	0.048		0.054
D	8.95		9.35	0.352		0.368
E	10.00		10.40	0.393		0.409
G	4.88	16	5.28	0.192	0.63	0.208
L	15.00		15.85	0.590		0.624
L2	1.27		1.40	0.050		0.055
L3	1.40		1.75	0.055		0.069
M	2.40		3.20	0.094		0.126
R		0.40 typ.			0.016 typ.	
V2	0°		8°	0°		8°

Figure 14. Footprint (dimensions in mm)

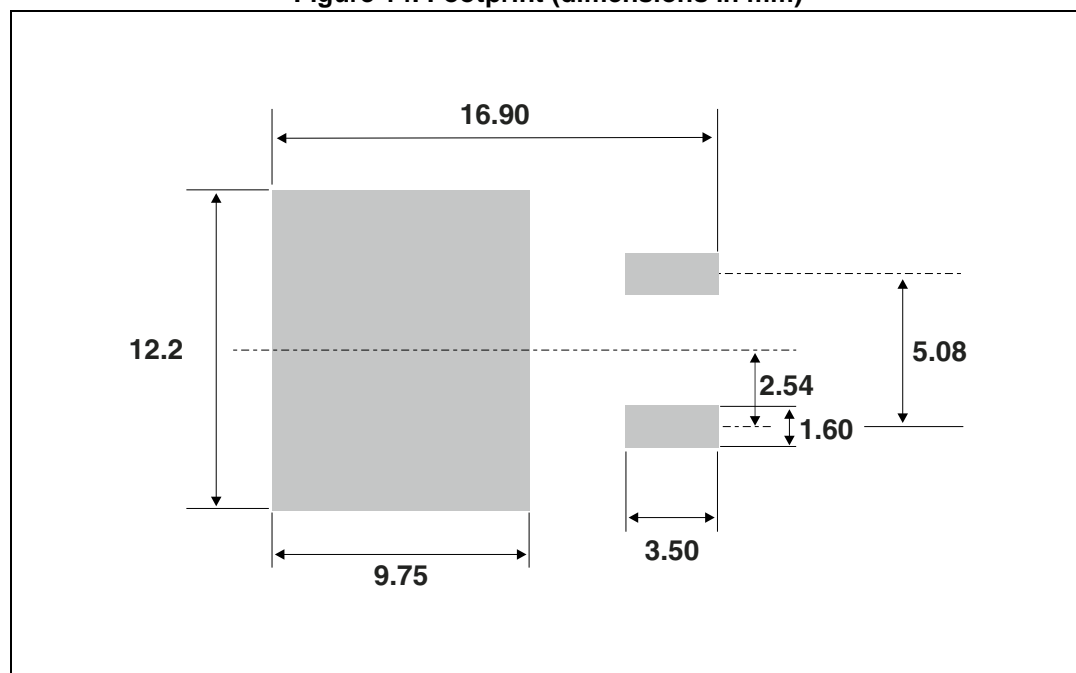

Figure 15. DO-247 dimension definitions

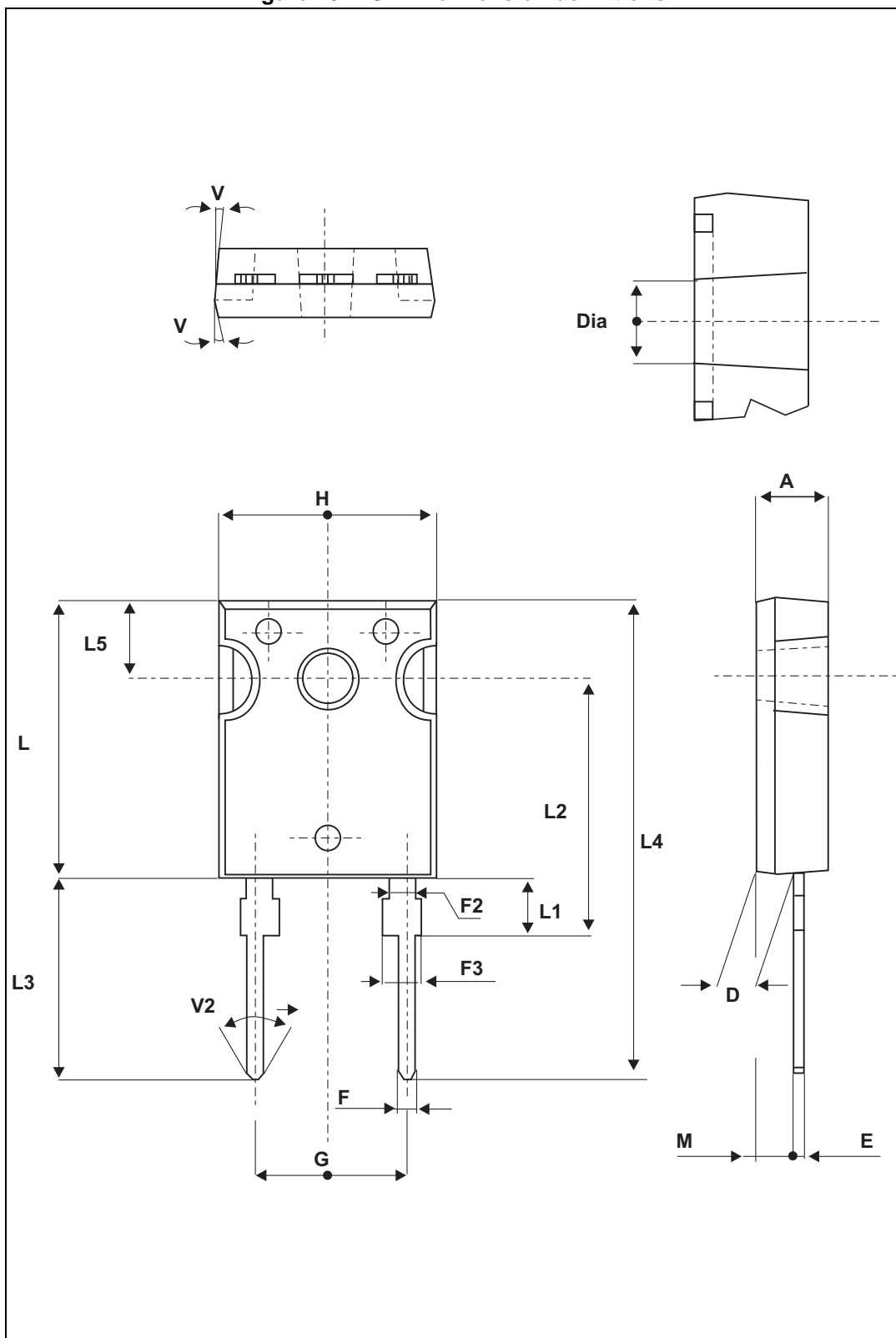

Table 7. DO-247 dimension values

Ref.	Dimensions					
	Millimeters			Inches		
	Min.	Typ.	Max.	Min.	Typ.	Max.
A	4.85		5.15	0.191		0.203
D	2.20		2.60	0.086		0.102
E	0.40		0.80	0.015		0.031
F	1.00		1.40	0.039		0.055
F2		2.00			0.078	
F3	2.00		2.40	0.078		0.094
G		10.90			0.429	
H	15.45		15.75	0.608		0.620
L	19.85		20.15	0.781		0.793
L1	3.70		4.30	0.145		0.169
L2		18.50			0.728	
L3	14.20		14.80	0.559		0.582
L4		34.60			1.362	
L5		5.50			0.216	
M	2.00		3.00	0.078		0.118
V		5°			5°	
V2		60°			60°	
Dia.	3.55		3.65	0.139		0.143

3 Ordering information

Table 8. Ordering information

Ordering type	Marking	Package	Weight	Base qty	Delivery mode
STTH30ST06WY	STTH30ST06WY	DO-247	4.40 g	30	Tube
STTH30ST06GY-TR	STTH30ST06GY	D ² PAK	1.48 g	1000	Tape and reel

4 Revision history

Table 9. Document revision history

Date	Revision	Changes
14-Jan-2015	1	First issue.

IMPORTANT NOTICE – PLEASE READ CAREFULLY

STMicroelectronics NV and its subsidiaries ("ST") reserve the right to make changes, corrections, enhancements, modifications, and improvements to ST products and/or to this document at any time without notice. Purchasers should obtain the latest relevant information on ST products before placing orders. ST products are sold pursuant to ST's terms and conditions of sale in place at the time of order acknowledgement.

Purchasers are solely responsible for the choice, selection, and use of ST products and ST assumes no liability for application assistance or the design of Purchasers' products.

No license, express or implied, to any intellectual property right is granted by ST herein.

Resale of ST products with provisions different from the information set forth herein shall void any warranty granted by ST for such product.

ST and the ST logo are trademarks of ST. All other product or service names are the property of their respective owners.

Information in this document supersedes and replaces information previously supplied in any prior versions of this document.

© 2015 STMicroelectronics – All rights reserved

