

National Semiconductor is now part of
Texas Instruments.

Search <http://www.ti.com/> for the latest technical
information and details on our current products and services.

LM4876 Boomer® Audio Power Amplifier Series

1.1W Audio Power Amplifier with Logic Low Shutdown

General Description

The LM4876 is a single 5V supply bridge-connected audio power amplifier capable of delivering 1.1W (typ) of continuous average power to an 8Ω load with 0.5% THD+N.

Like other audio amplifiers in the Boomer series, the LM4876 is designed specifically to provide high quality output power with a minimal amount of external components. The LM4876 does not require output coupling capacitors, bootstrap capacitors, or snubber networks. It is perfectly suited for low-power portable systems.

The LM4876 features an active low externally controlled, micro-power shutdown mode. Additionally, the LM4876 features an internal thermal shutdown protection mechanism. For PCB space efficiency, the LM4876 is available in MSOP and SO surface mount packages.

The unity-gain stable LM4876's closed loop gain is set using external resistors.

Key Specifications

■ THD+N at 1kHz for 1W continuous average output power into 8Ω	0.5% (max)
■ Output power at 1kHz into 8Ω with 10% THD+N	1.5W (typ)
■ Shutdown current	0.01μA (typ)
■ Supply voltage range	2.0V to 5.5V

Features

- Does not require output coupling capacitors, bootstrap capacitors, or snubber circuits
- 10-pin MSOP and 8-pin SO packages
- Unity-gain stable
- External gain set

Applications

- Mobile Phones
- Portable Computers
- Desktop Computers
- Low-Voltage Audio Systems

Typical Application

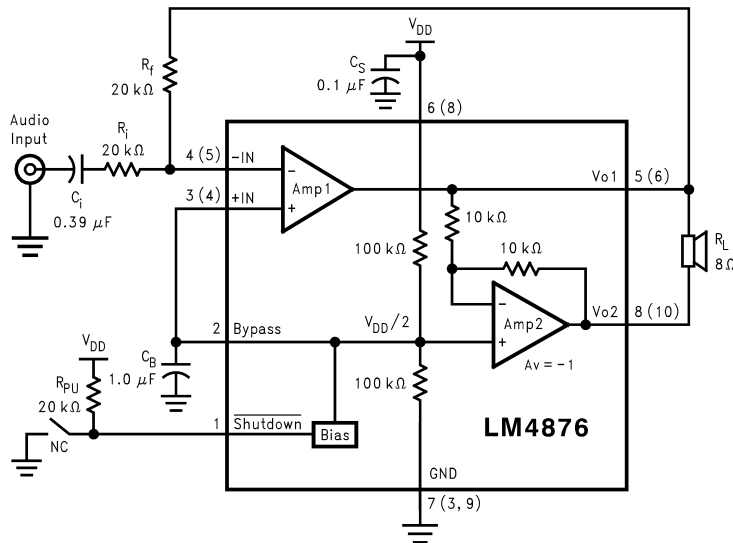

10129901

FIGURE 1. Typical LM4876 Audio Amplifier Application Circuit.
Numbers in () are specific to the 10-pin MSOP package

Connection Diagrams

Mini Small Outline MSOP Package

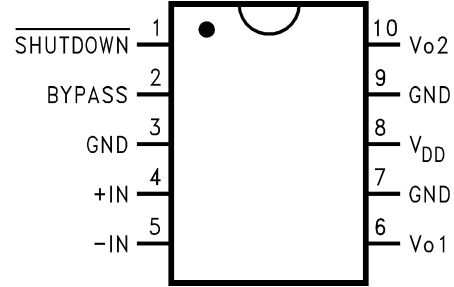

10129925

Top View
Order Number LM4876MM
See NS Package Number MUB10A

Small Outline SO Package

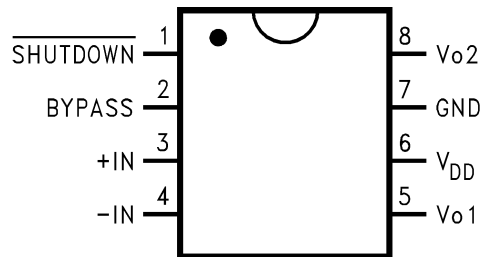

10129902

Top View
Order Number LM4876M
See NS Package Number M08A

Absolute Maximum Ratings (Note 2)

If Military/Aerospace specified devices are required, please contact the National Semiconductor Sales Office/Distributors for availability and specifications.

Supply Voltage	6.0V
Storage Temperature	-65°C to +150°C
Input Voltage	-0.3V to $V_{DD} + 0.3V$
Power Dissipation (Note 3)	Internally Limited
ESD Susceptibility (Note 4)	2500V
ESD Susceptibility (Note 5)	250V
Junction Temperature	150°C
Soldering Information	
Small Outline Package	
Vapor Phase (60 sec.)	215°C

Infrared (15 sec.)

220°C

See AN-450 "Surface Mounting and their Effects on Product Reliability" for other methods of soldering surface mount devices.

θ_{JC} (typ) — MUB10A	56°C/W
θ_{JA} (typ) — MUB10A	210°C/W
θ_{JC} (typ) — M08A	35°C/W
θ_{JA} (typ) — M08A	140°C/W

Operating Ratings

Temperature Range

$$T_{MIN} \leq T_A \leq T_{MAX}$$

$$-40^\circ\text{C} \leq T_A \leq 85^\circ\text{C}$$

Supply Voltage

$$2.0V \leq V_{DD} \leq 5.5V$$

Electrical Characteristics (Notes 1, 2)

The following specifications apply for $V_{DD} = 5V$ unless otherwise specified. Limits apply for $T_A = 25^\circ\text{C}$.

Symbol	Parameter	Conditions	LM4876		Units (Limits)
			Typical	Limit	
			(Note 6)	(Note 7)	
V_{DD}	Supply Voltage			2.0 5.5	V (min) V (max)
I_{DD}	Quiescent Power Supply Current	$V_{IN} = 0V, I_o = 0A$	6.5	10.0	mA (max)
I_{SD}	Shutdown Current	$V_{PIN1} = 0V$	0.01	2	μA (max)
V_{OS}	Output Offset Voltage	$V_{IN} = 0V$	5	50	mV (max)
P_o	Output Power	THD = 0.5% (max); f = 1 kHz; $R_L = 8\Omega$	1.10	1.0	W (min)
		THD+N = 10%; f = 1 kHz; $R_L = 8\Omega$	1.5		W
THD+N	Total Harmonic Distortion+Noise	$P_o = 1 \text{ Wrms}; A_{VD} = 2; 20 \text{ Hz} \leq f \leq 20 \text{ kHz}; R_L = 8\Omega$	0.25		%
PSRR	Power Supply Rejection Ratio	$V_{DD} = 4.9V \text{ to } 5.1V$	65		dB

Note 1: All voltages are measured with respect to the ground pin, unless otherwise specified.

Note 2: *Absolute Maximum Ratings* indicate limits beyond which damage to the device may occur. *Operating Ratings* indicate conditions for which the device is functional, but do not guarantee specific performance limits. *Electrical Characteristics* state DC and AC electrical specifications under particular test conditions that guarantee specific performance limits. This assumes that the device operates within the Operating Ratings. Specifications are not guaranteed for parameters where no limit is given. The typical value, however, is a good indication of device performance.

Note 3: The maximum power dissipation must be derated at elevated temperatures and is dictated by T_{JMAX} , θ_{JA} , and the ambient temperature T_A . The maximum allowable power dissipation is $P_{DMAX} = (T_{JMAX} - T_A) / \theta_{JA}$ or the number given in Absolute Maximum Ratings, whichever is lower. For the LM4876, $T_{JMAX} = 150^\circ\text{C}$. The typical junction-to-ambient thermal resistance is 140°C/W for the M08A package and 210°C/W for the MUB10A package.

Note 4: Human body model, 100 pF discharged through a 1.5 k Ω resistor.

Note 5: Machine Model, 220 pF–240 pF discharged through all pins.

Note 6: Typicals are measured at 25°C and represent the parametric norm.

Note 7: Limits are guaranteed to National's AOQL (Average Outgoing Quality Level).

Electrical Characteristics $V_{DD} = 5/3.3/2.6V$

Symbol	Parameter	Conditions	LM4876		Units (Limits)
			Typical	Limit	
			(Note 6)	(Note 7)	
V_{IH}	Shutdown Input Voltage High			1.2	V(min)
V_{IL}	Shutdown Input Voltage Low			0.4	V(max)

External Components Description

(Figure 1)

Components		Functional Description
1.	R_i	Inverting input resistance which sets the closed-loop gain in conjunction with R_f . This resistor also forms a high pass filter with C_i at $f_C = 1/(2\pi R_i C_i)$.
2.	C_i	Input coupling capacitor which blocks the DC voltage at the amplifiers input terminals. Also creates a highpass filter with R_i at $f_C = 1/(2\pi R_i C_i)$. Refer to the section, Proper Selection of External Components , for an explanation of how to determine the value of C_i .
3.	R_f	Feedback resistance which sets the closed-loop gain in conjunction with R_i .
4.	C_S	Supply bypass capacitor which provides power supply filtering. Refer to the Power Supply Bypassing section for information concerning proper placement and selection of the supply bypass capacitor.
5.	C_B	Bypass pin capacitor which provides half-supply filtering. Refer to the section, Proper Selection of External Components , for information concerning proper placement and selection of C_B .

Typical Performance Characteristics

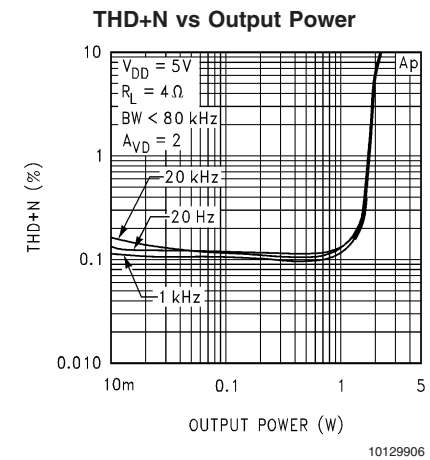
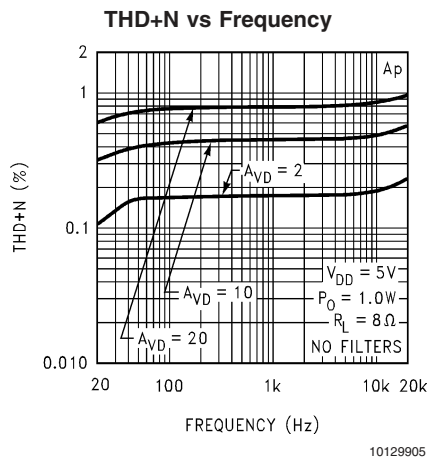
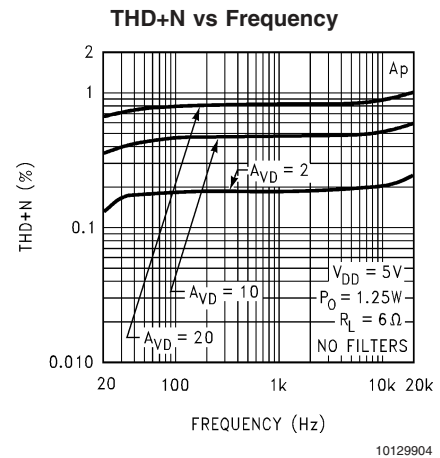
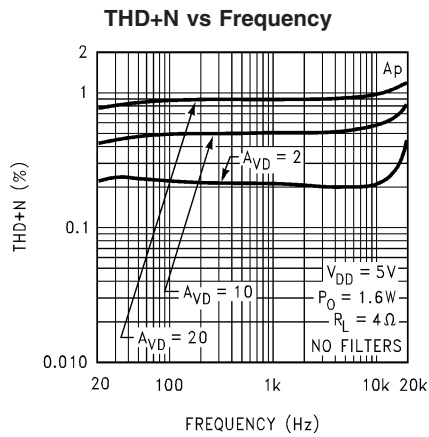

Typical Performance Characteristics (Continued)

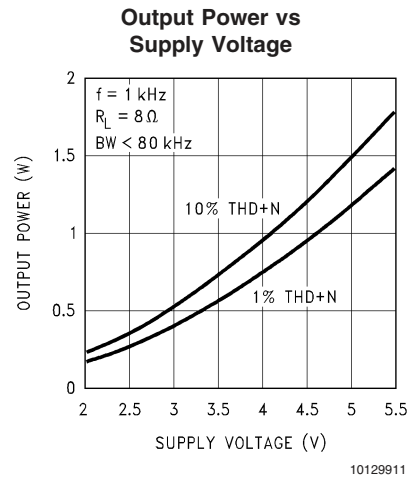
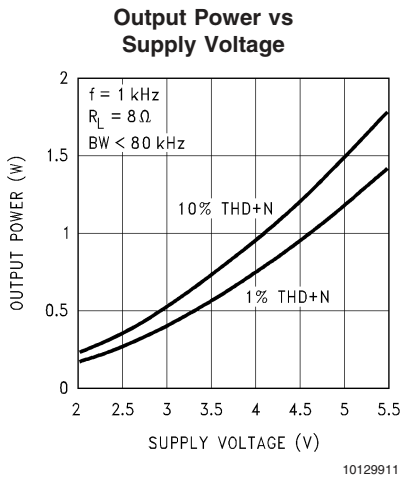
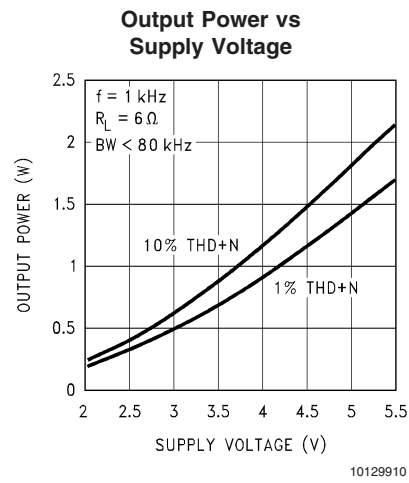
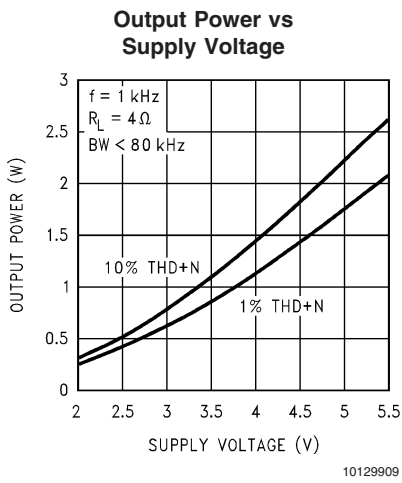
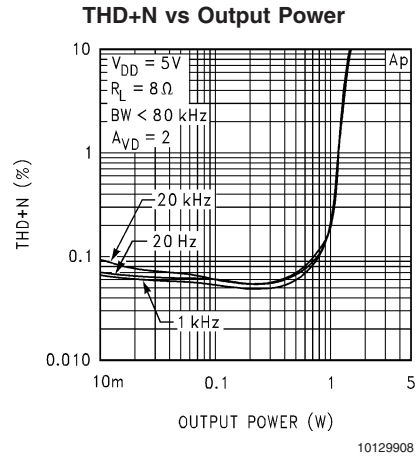
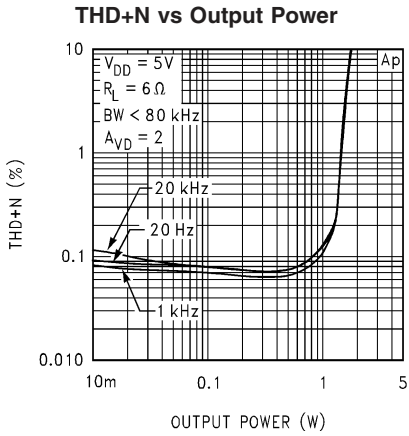

Typical Performance Characteristics (Continued)

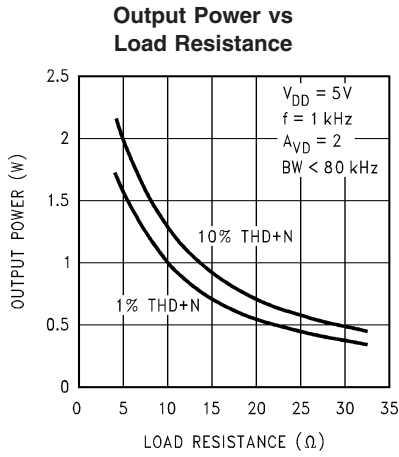

10129912

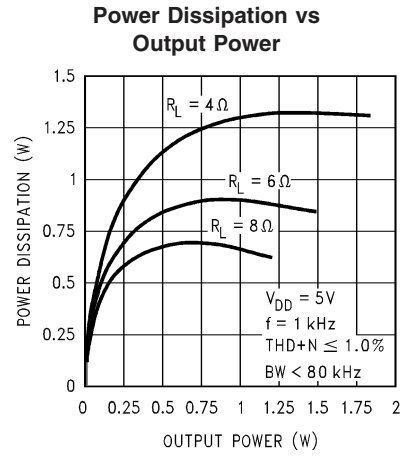

10129913

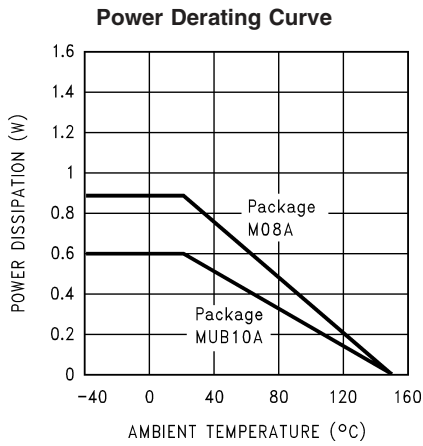

10129914

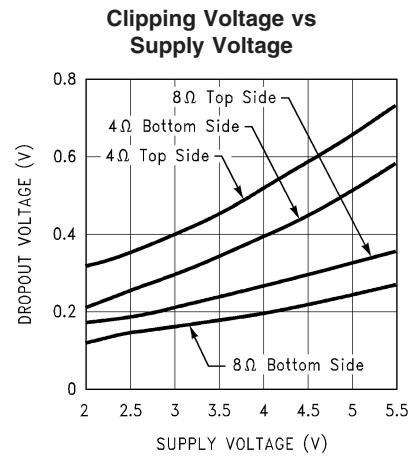

10129915

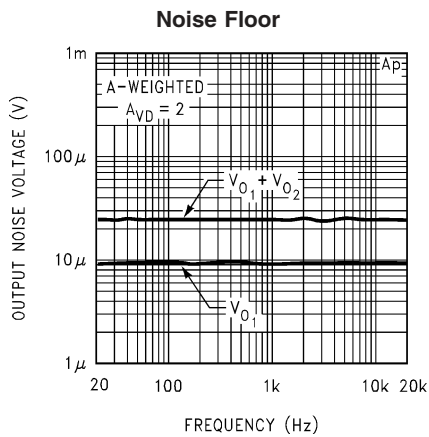

10129916

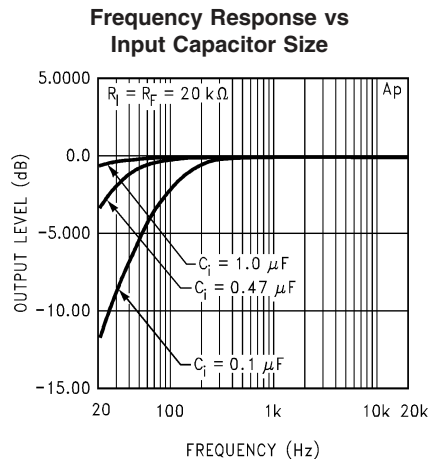

10129917

Typical Performance Characteristics (Continued)

Power Supply Rejection Ratio

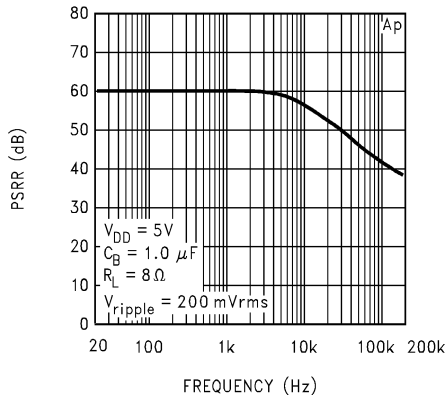

10129918

Open Loop Frequency Response

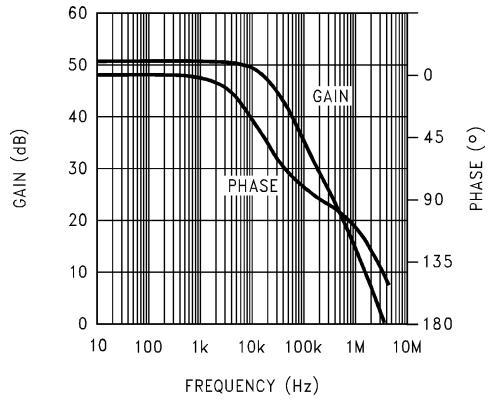

10129919

Supply Current vs Supply Voltage

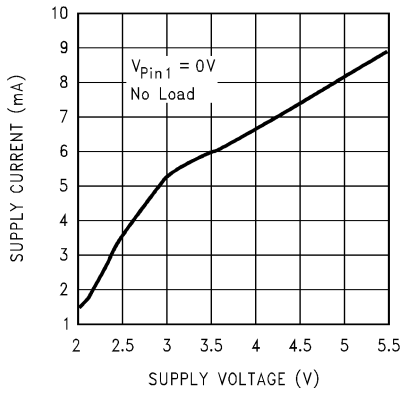

10129920

Supply Current vs Shutdown Voltage
 LM4876 @ VDD = 5/3.3/2.6Vdc

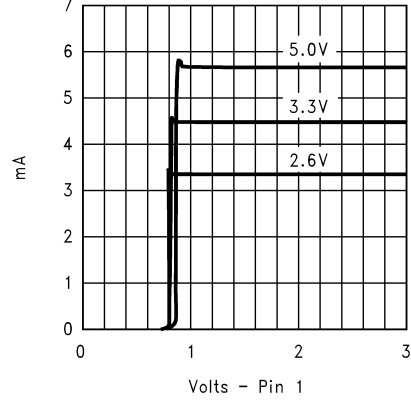

10129923

Application Information

BRIDGE CONFIGURATION EXPLANATION

As shown in *Figure 1*, the LM4876 consists of two operational amplifiers. External resistors R_f and R_i set the closed-loop gain of Amp1, whereas two internal 40k Ω resistors set Amp2's gain at -1. The LM4876 drives a load, such as a speaker, connected between the two amplifier outputs, V_{o1} and V_{o2} .

Figure 1 shows that the Amp1 output serves as the Amp2 input, which results in both amplifiers producing signals identical in magnitude, but 180° out of phase. Taking advantage of this phase difference, a load is placed between V_{o1} and V_{o2} and driven differentially (commonly referred to as "bridge mode"). This results in a differential gain of

$$A_{VD} = 2 * (R_f/R_i) \quad (1)$$

Bridge mode is different from single-ended amplifiers that drive loads connected between a single amplifier's output and ground. For a given supply voltage, bridge mode has a distinct advantage over the single-ended configuration: its differential output doubles the voltage swing across the load. This results in four times the output power when compared to a single-ended amplifier under the same conditions. This increase in attainable output power assumes that the amplifier is not current limited or that the output signal is not clipped. To ensure minimum output signal clipping when choosing an amplifier's closed-loop gain, refer to the **Audio Power Amplifier Design** section.

Another advantage of the differential bridge output is no net DC voltage across the load. This results from biasing V_{o1} and V_{o2} at half-supply. This eliminates the coupling capacitor that single supply, single-ended amplifiers require. Eliminating an output coupling capacitor in a single-ended configuration forces a single-supply amplifier's half-supply bias voltage across the load. The current flow created by the half-supply bias voltage increases internal IC power dissipation and may permanently damage loads such as speakers.

POWER DISSIPATION

Power dissipation is a major concern when designing a successful bridged or single-ended amplifier. Equation (2) states the maximum power dissipation point for a single-ended amplifier operating at a given supply voltage and driving a specified output load.

$$P_{DD} = (V_{DD})^2 / (2\pi^2 R_L) \text{ Single-Ended} \quad (2)$$

However, a direct consequence of the increased power delivered to the load by a bridge amplifier is higher internal power dissipation for the same conditions.

The LM4876 has two operational amplifiers in one package and the maximum internal power dissipation is four times that of a single-ended amplifier. Equation (3) states the maximum power dissipation for a bridge amplifier. However, even with this substantial increase in power dissipation, the LM4876 does not require heatsinking. From Equation (3), assuming a 5V power supply and an 8 Ω load, the maximum power dissipation point is 633mW.

$$P_{DD} = 4 * (V_{DD})^2 / (2\pi^2 R_L) \text{ Bridge Mode} \quad (3)$$

The maximum power dissipation point given by Equation (3) must not exceed the power dissipation given by Equation (4):

$$P_{DD} = (T_{JMAX} - T_A) / \theta_{JA} \quad (4)$$

The LM4876's $T_{JMAX} = 150^\circ\text{C}$. In the M08A package, the LM4876's θ_{JA} is 140°C/W. At any given ambient temperature T_A , use Equation (4) to find the maximum internal power

dissipation supported by the IC packaging. Rearranging Equation (4) results in Equation (5). This equation gives the maximum ambient temperature that still allows maximum power dissipation without violating the LM4876's maximum junction temperature.

$$T_A = T_{JMAX} - P_{DD} \theta_{JA} \quad (5)$$

For a typical application with a 5V power supply and an 8W load, the maximum ambient temperature that allows maximum power dissipation without exceeding the maximum junction temperature is approximately 61°C.

$$T_{JMAX} = P_{DD} \theta_{JA} + T_A \quad (6)$$

For the MSOP10A package, $\theta_{JA} = 210^\circ\text{C/W}$. Equation (6) shows that T_{JMAX} , for the MSOP10 package, is 158°C for an ambient temperature of 25°C and using the same 5V power supply and an 8 Ω load. This violates the LM4876's 150°C maximum junction temperature when using the MSOP10A package. Reduce the junction temperature by reducing the power supply voltage or increasing the load resistance. Further, allowance should be made for increased ambient temperatures. To achieve the same 61°C maximum ambient temperature found for the M08 package, the MSOP10 packaged part should operate on a 4.1V supply voltage when driving an 8 Ω load. Alternatively, a 5V supply can be used when driving a load with a minimum resistance of 12 Ω for the same 61°C maximum ambient temperature.

Fully charged Li-ion batteries typically supply 4.3V to portable applications such as cell phones. This supply voltage allows the LM4876 to drive loads with a minimum resistance of 9 Ω without violating the maximum junction temperature when the maximum ambient temperature is 61°C.

The above examples assume that a device is a surface mount part operating around the maximum power dissipation point. Since internal power dissipation is a function of output power, higher ambient temperatures are allowed as output power or duty cycle decreases.

If the result of Equation (3) is greater than that of Equation (4), then decrease the supply voltage, increase the load impedance, or reduce the ambient temperature. If these measures are insufficient, a heat sink can be added to reduce θ_{JA} . The heat sink can be created using additional copper area around the package, with connections to the ground pin(s), supply pin and amplifier output pins. When adding a heat sink, the θ_{JA} is the sum of θ_{JC} , θ_{CS} , and θ_{SA} . (θ_{JC} is the junction-to-case thermal impedance, θ_{CS} is the case-to-sink thermal impedance, and θ_{SA} is the sink-to-ambient thermal impedance.) Refer to the **Typical Performance Characteristics** curves for power dissipation information at lower output power levels.

POWER SUPPLY BYPASSING

As with any power amplifier, proper supply bypassing is critical for low noise performance and high power supply rejection. Applications that employ a 5V regulator typically use a 10 μF in parallel with a 0.1 μF filter capacitors to stabilize the regulator's output, reduce noise on the supply line, and improve the supply's transient response. However, their presence does not eliminate the need for local bypass capacitance at the LM4876's supply pins. Keep the length of leads and traces that connect capacitors between the LM4876's power supply pin and ground as short as possible. Connecting a 1 μF capacitor between the BYPASS pin and ground improves the internal bias voltage's stability and improves the amplifier's PSRR. The PSRR improvements increase as the bypass pin capacitor value increases. Too large, however, and the amplifier's click and pop perfor-

Application Information (Continued)

mance can be compromised. The selection of bypass capacitor values, especially C_B , depends on desired PSRR requirements, click and pop performance (as explained in the section, **Proper Selection of External Components**), system cost, and size constraints.

MICRO-POWER SHUTDOWN

The voltage applied to the $\overline{\text{SHUTDOWN}}$ pin controls the LM4876's shutdown function. Activate micro-power shutdown by applying a voltage below 400mV to the $\overline{\text{SHUTDOWN}}$ pin. When active, the LM4876's micro-power shutdown feature turns off the amplifier's bias circuitry, reducing the supply current. Though the LM4876 is in shutdown when 400mV is applied to the $\overline{\text{SHUTDOWN}}$ pin, the supply current may be higher than 0.01 μ A (typ) shutdown current. Therefore, for the lowest supply current during shutdown, connect the $\overline{\text{SHUTDOWN}}$ pin to ground. The relationship between the supply voltage, the shutdown current, and the voltage applied to the $\overline{\text{SHUTDOWN}}$ pin is shown in **Typical Performance Characteristics** curves.

There are a few ways to control the micro-power shutdown. These include using a single-pole, single-throw switch, a microprocessor, or a microcontroller. When using a switch, connect an external pull-down resistor between the $\overline{\text{SHUTDOWN}}$ pin and GND. Connect the switch between the $\overline{\text{SHUTDOWN}}$ pin and V_{CC} . Select normal amplifier operation by closing the switch. Opening the switch connects the $\overline{\text{SHUTDOWN}}$ pin to GND through the pull-down resistor, activating micro-power shutdown. The switch and resistor guarantee that the $\overline{\text{SHUTDOWN}}$ pin will not float. This prevents unwanted state changes. In a system with a microprocessor or a microcontroller, use a digital output to apply the control voltage to the $\overline{\text{SHUTDOWN}}$ pin. Driving the $\overline{\text{SHUTDOWN}}$ pin with active circuitry eliminates the pull down resistor.

SELECTING POWER EXTERNAL COMPONENTS

Optimizing the LM4876's performance requires properly selecting external components. Though the LM4876 operates well when using external components with wide tolerances, best performance is achieved by optimizing component values.

The LM4876 is unity-gain stable, giving a designer maximum design flexibility. The gain should be set to no more than a given application requires. This allows the amplifier to achieve minimum THD+N and maximum signal-to-noise ratio. These parameters are compromised as the closed-loop gain increases. However, low gain demands input signals

with greater voltage swings to achieve maximum output power. Fortunately, many signal sources such as audio CODECs have outputs of 1 V_{RMS} (2.83 V_{P-P}). Please refer to the **Audio Power Amplifier Design** section for more information on selecting the proper gain.

Input Capacitor Value Selection

Amplifying the lowest audio frequencies requires high value input coupling capacitor (C_i in *Figure 1*). A high value capacitor can be expensive and may compromise space efficiency in portable designs. In many cases, however, the speakers used in portable systems, whether internal or external, have little ability to reproduce signals below 150 Hz. Applications using speakers with this limited low frequency response reap little improvement by using a large input capacitor.

Besides affecting system cost and size, C_i also affects the LM4876's click and pop performance. When the supply voltage is first applied, a transient (pop) is created as the charge on the input capacitor changes from zero to a quiescent state. The magnitude of the pop is directly proportional to the input capacitor's size. Higher value capacitors need more time to reach a quiescent DC voltage (usually $V_{CC}/2$) when charged with a fixed current. The amplifier's output charges the input capacitor through the feedback resistor, R_f . Thus, pops can be minimized by selecting an input capacitor value that is no higher than necessary to meet the desired -3dB frequency.

As shown in *Figure 1*, the input resistor (R_i) and the input capacitor, C_i produce a -3dB high pass filter cutoff frequency that is found using Equation (7).

$$f_{-3dB} = 2\pi R_{iN} C_i \quad (7)$$

As an example when using a speaker with a low frequency limit of 150Hz, Equation (7) gives a value of C_i equal to 0.1 μ F. The 0.22 μ F C_i shown in *Figure 1* allows for a speaker whose response extends down to 75Hz.

Bypass Capacitor Value Selection

Besides minimizing the input capacitor size, careful consideration should be paid to value of, C_B , the capacitor connected to the BYPASS pin. Since C_B determines how fast the LM4876 settles to quiescent operation, its value is critical when minimizing turn-on pops. The slower the LM4876's outputs ramp to their quiescent DC voltage (nominally $1/2 V_{DD}$), the smaller the turn-on pop. Choosing C_B equal to 1.0 μ F along with a small value of C_i (in the range of 0.1 μ F to 0.39 μ F), produces a click-less and pop-less shutdown function. As discussed above, choosing C_i as small as possible helps minimize clicks and pops.

Application Information (Continued)

AUDIO POWER AMPLIFIER DESIGN

Audio Amplifier Design: Driving 1W into an 8Ω Load

The following are the desired operational parameters:

Power Output	1W _{RMS}
Load Impedance	8Ω
Input Level	1V _{RMS}
Input Impedance	20kΩ
Bandwidth	100Hz–20kHz ± 0.25dB

The design begins by specifying the minimum supply voltage necessary to obtain the specified output power. One way to find the minimum supply voltage is to use the Output Power vs Supply Voltage curve in the **Typical Performance Characteristics** section. Another way, using Equation (8), is to calculate the peak output voltage necessary to achieve the desired output power for a given load impedance. To account for the amplifier's dropout voltage, two additional voltages, based on the Dropout Voltage vs Supply Voltage in the **Typical Performance Characteristics** curves, must be added to the result obtained by Equation (8). This results in Equation (9).

$$V_{\text{OUTPEAK}} = \sqrt{(2R_L P_O)} \quad (8)$$

$$V_{CC} \geq (V_{\text{OUTPEAK}} + (V_{\text{ODTOP}} + V_{\text{ODBOT}})) \quad (9)$$

The Output Power vs Supply Voltage graph for an 8Ω load indicates a minimum supply voltage of 4.6V. This is easily met by the commonly used 5V supply voltage. The additional voltage creates the benefit of headroom, allowing the LM4876 to produce peak output power in excess of 1W without clipping or other audible distortion. The choice of supply voltage must also not create a violation of maximum power dissipation as explained above in the **Power Dissipation** section.

After satisfying the LM4876's power dissipation requirements, the minimum differential gain is found using Equation (10).

$$\sqrt{(P_O R_L)/(V_{IN})} = V_{\text{ORMS}}/V_{\text{INRMS}} \quad (10)$$

Thus, a minimum gain of 2.83 allows the LM4876's to reach full output swing and maintain low noise and THD+N performance. For this example, let $A_{VD} = 3$.

The amplifier's overall gain is set using the input (R_i) and feedback (R_f) resistors. With the desired input impedance set at 20kΩ, the feedback resistor is found using Equation (11).

$$R_f/R_i = A_{VD}/2 \quad (11)$$

The value of R_f is 30kΩ.

The last step in this design example is setting the amplifier's -3dB low frequency bandwidth. To achieve the desired ±0.25dB pass band magnitude variation limit, the low frequency response must extend to at least one-fifth the lower bandwidth limit and the high frequency response must extend to at least five times the upper bandwidth limit. The results is an

$$f_L = 100 \text{ Hz}/5 = 20\text{Hz}$$

and an

$$F_H = 20 \text{ kHz} * 5 = 100\text{kHz}$$

As mentioned in the External Components section, R_i and C_i create a highpass filter that sets the amplifier's lower band-pass frequency limit. Find the coupling capacitor's value using Equation (12).

$$C_i \geq 1/(2\pi R_i f_L) \quad (12)$$

The result is

$$1/(2\pi * 20\text{k}\Omega * 20\text{Hz}) = 0.398\mu\text{F}$$

Use a 0.39μF capacitor, the closest standard value.

The product of the desired high frequency cutoff (100kHz in this example) and the differential gain, A_{VD} , determines the upper passband response limit. With $A_{VD} = 3$ and $f_H = 100\text{kHz}$, the closed-loop gain bandwidth product (GBWP) is 150kHz. This is less than the LM4876's 4MHz GBWP. With this margin, the amplifier can be used in designs that require more differential gain and avoid performance-restricting bandwidth limitations.

Physical Dimensions inches (millimeters)

unless otherwise noted

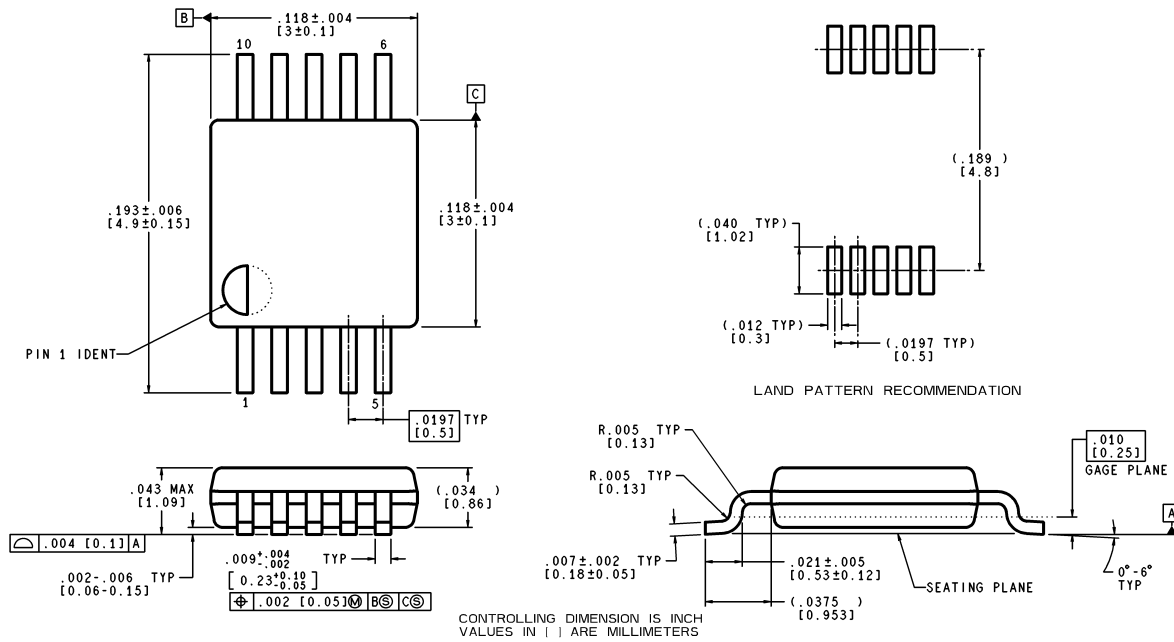

MUB10A (Rev A)

Order Number LM4876MM NS Package Number MUB10A

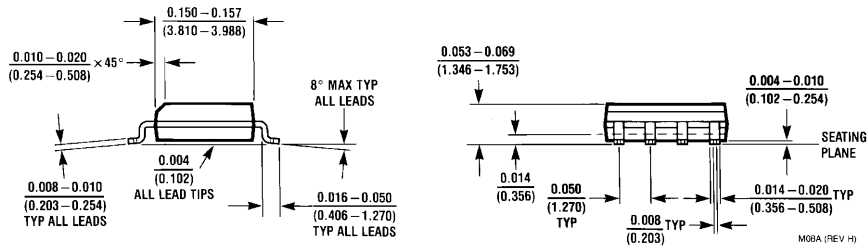
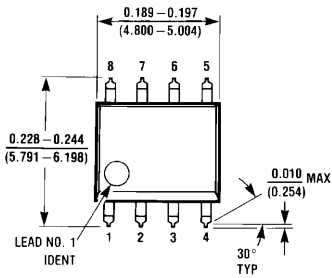

Order Number LM4876M NS Package Number M08A

Notes

LIFE SUPPORT POLICY

NATIONAL'S PRODUCTS ARE NOT AUTHORIZED FOR USE AS CRITICAL COMPONENTS IN LIFE SUPPORT DEVICES OR SYSTEMS WITHOUT THE EXPRESS WRITTEN APPROVAL OF THE PRESIDENT AND GENERAL COUNSEL OF NATIONAL SEMICONDUCTOR CORPORATION. As used herein:

1. Life support devices or systems are devices or systems which, (a) are intended for surgical implant into the body, or (b) support or sustain life, and whose failure to perform when properly used in accordance with instructions for use provided in the labeling, can be reasonably expected to result in a significant injury to the user.
2. A critical component is any component of a life support device or system whose failure to perform can be reasonably expected to cause the failure of the life support device or system, or to affect its safety or effectiveness.



National Semiconductor
Americas Customer
Support Center
Email: new.feedback@nsc.com
Tel: 1-800-272-9959

www.national.com

National Semiconductor
Europe Customer Support Center
Fax: +49 (0) 180-530 85 86
Email: europe.support@nsc.com
Deutsch Tel: +49 (0) 69 9508 6208
English Tel: +44 (0) 870 24 0 2171
Français Tel: +33 (0) 1 41 91 8790

National Semiconductor
Asia Pacific Customer
Support Center
Fax: +65-6250 4466
Email: ap.support@nsc.com
Tel: +65-6254 4466

National Semiconductor
Japan Customer Support Center
Fax: 81-3-5639-7507
Email: jpn.feedback@nsc.com
Tel: 81-3-5639-7560