

# IRF7555

HEXFET® Power MOSFET

- Trench Technology
- Ultra Low On-Resistance
- Dual P-Channel MOSFET
- Very Small SOIC Package
- Low Profile (<1.1mm)
- Available in Tape & Reel

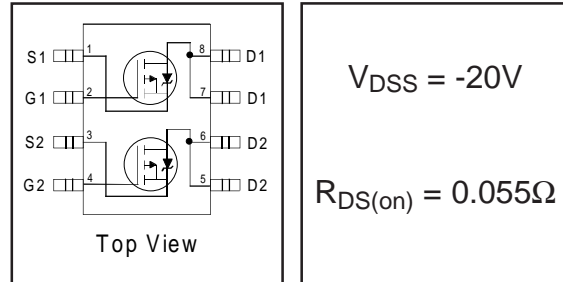

## Description

New trench HEXFET® power MOSFETs from International Rectifier utilize advanced processing techniques to achieve extremely low on-resistance per silicon area. This benefit, combined with the ruggedized device design that HEXFET Power MOSFETs are well known for, provides the designer with an extremely efficient and reliable device for use in a wide variety of applications.

The new Micro8™ package has half the footprint area of the standard SO-8. This makes the Micro8 an ideal package for applications where printed circuit board space is at a premium. The low profile (<1.1 mm) of the Micro8 will allow it to fit easily into extremely thin application environments such as portable electronics and PCMCIA cards.

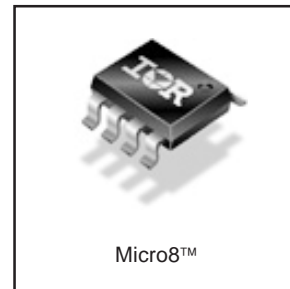

## Absolute Maximum Ratings

	Parameter	Max.	Units
$V_{DS}$	Drain-Source Voltage	-20	V
$I_D @ T_A = 25^\circ C$	Continuous Drain Current, $V_{GS} @ -4.5V$	-4.3	A
$I_D @ T_A = 70^\circ C$	Continuous Drain Current, $V_{GS} @ -4.5V$	-3.4	
$I_{DM}$	Pulsed Drain Current <sup>①</sup>	-34	
$P_D @ T_A = 25^\circ C$	Maximum Power Dissipation <sup>④</sup>	1.25	W
$P_D @ T_A = 70^\circ C$	Maximum Power Dissipation <sup>④</sup>	0.8	W
	Linear Derating Factor	10	mW/°C
$V_{GS}$	Gate-to-Source Voltage	$\pm 12$	V
$E_{AS}$	Single Pulse Avalanche Energy <sup>④</sup>	36	mJ
dv/dt	Peak Diode Recovery dv/dt <sup>②</sup>	1.1	V/ns
$T_J, T_{STG}$	Junction and Storage Temperature Range	-55 to +150	°C
	Soldering Temperature, for 10 seconds	240 (1.6mm from case)	

## Thermal Resistance

	Parameter	Max.	Units
$R_{\theta JA}$	Maximum Junction-to-Ambient <sup>④</sup>	100	°C/W

## Electrical Characteristics @ $T_J = 25^\circ\text{C}$ (unless otherwise specified)

	Parameter	Min.	Typ.	Max.	Units	Conditions
$V_{(BR)DSS}$	Drain-to-Source Breakdown Voltage	-20	—	—	V	$V_{GS} = 0V, I_D = -250\mu A$
$\Delta V_{(BR)DSS}/\Delta T_J$	Breakdown Voltage Temp. Coefficient	—	-0.005	—	V/ $^\circ\text{C}$	Reference to $25^\circ\text{C}, I_D = -1\text{mA}$
$R_{DS(on)}$	Static Drain-to-Source On-Resistance	—	—	0.055	$\Omega$	$V_{GS} = -4.5V, I_D = -4.3A$ ③
		—	—	0.105		$V_{GS} = -2.5V, I_D = -3.4A$ ③
$V_{GS(th)}$	Gate Threshold Voltage	-0.60	—	-1.2	V	$V_{DS} = V_{GS}, I_D = -250\mu A$
$g_{fs}$	Forward Transconductance	2.5	—	—	S	$V_{DS} = -10V, I_D = -0.8A$
$I_{DSS}$	Drain-to-Source Leakage Current	—	—	-1.0	$\mu A$	$V_{DS} = -16V, V_{GS} = 0V$
		—	—	-25		$V_{DS} = -16V, V_{GS} = 0V, T_J = 125^\circ\text{C}$
$I_{GSS}$	Gate-to-Source Forward Leakage	—	—	-100	nA	$V_{GS} = -12V$
	Gate-to-Source Reverse Leakage	—	—	100		$V_{GS} = 12V$
$Q_g$	Total Gate Charge	—	10	15	nC	$I_D = -3.0A$
$Q_{gs}$	Gate-to-Source Charge	—	2.1	3.1		$V_{DS} = -10V$
$Q_{gd}$	Gate-to-Drain ("Miller") Charge	—	2.5	3.7		$V_{GS} = -5.0V$
$t_{d(on)}$	Turn-On Delay Time	—	10	—	ns	$V_{DD} = -10V$
$t_r$	Rise Time	—	46	—		$I_D = -2.0A$
$t_{d(off)}$	Turn-Off Delay Time	—	60	—		$R_G = 6.0\Omega$
$t_f$	Fall Time	—	64	—		$R_D = 5.0\Omega$ ③
$C_{iss}$	Input Capacitance	—	1066	—	pF	$V_{GS} = 0V$
$C_{oss}$	Output Capacitance	—	402	—		$V_{DS} = -10V$
$C_{rss}$	Reverse Transfer Capacitance	—	126	—		$f = 1.0\text{MHz}$

## Source-Drain Ratings and Characteristics

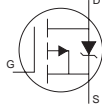
	Parameter	Min.	Typ.	Max.	Units	Conditions
$I_S$	Continuous Source Current (Body Diode)	—	—	-1.3	A	MOSFET symbol showing the integral reverse p-n junction diode. 
$I_{SM}$	Pulsed Source Current (Body Diode) ①	—	—	-34		
$V_{SD}$	Diode Forward Voltage	—	—	-1.2	V	$T_J = 25^\circ\text{C}, I_S = -1.6A, V_{GS} = 0V$ ③
$t_{rr}$	Reverse Recovery Time	—	54	82	ns	$T_J = 25^\circ\text{C}, I_F = -2.5A$
$Q_{rr}$	Reverse Recovery Charge	—	41	61	nC	$di/dt = -100A/\mu s$ ③

### Notes:

- ① Repetitive rating; pulse width limited by max. junction temperature.
- ②  $I_{SD} \leq -2.0A, di/dt \leq -140A/\mu s, V_{DD} \leq V_{(BR)DSS}, T_J \leq 150^\circ\text{C}$
- ③ Pulse width  $\leq 300\mu s$ ; duty cycle  $\leq 2\%$ .

④ Surface mounted on FR-4 board,  $t \leq 10\text{sec}$ .

⑤ Starting  $T_J = 25^\circ\text{C}, L = 8.0\text{mH}$   
 $R_G = 25\Omega, I_{AS} = -3.0A$ .

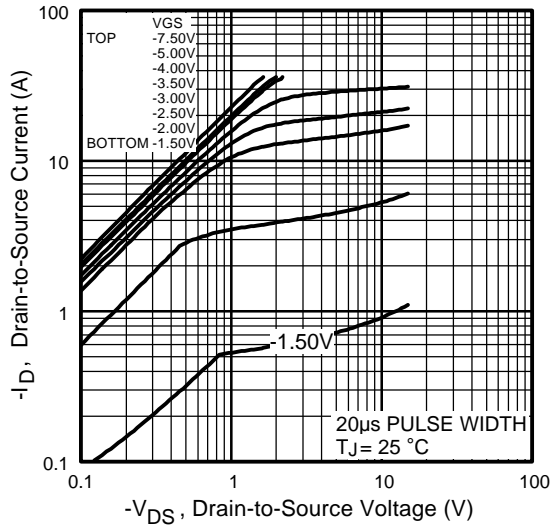

Fig 1. Typical Output Characteristics

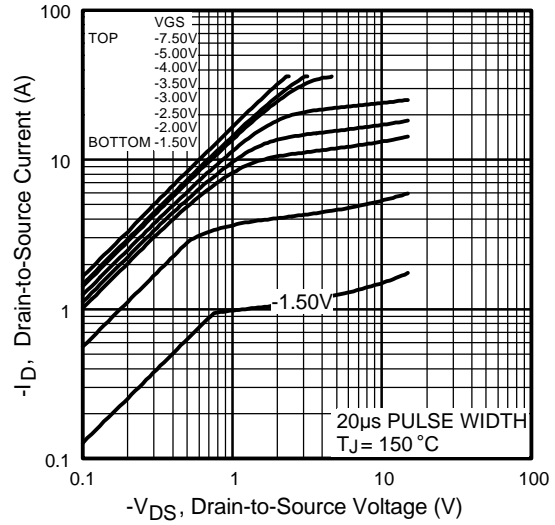

Fig 2. Typical Output Characteristics

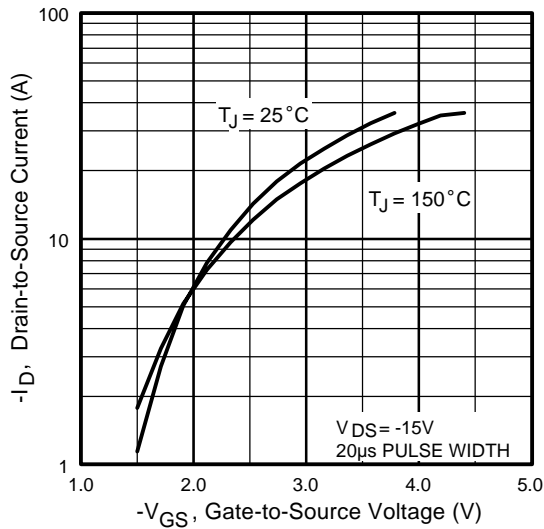

Fig 3. Typical Transfer Characteristics

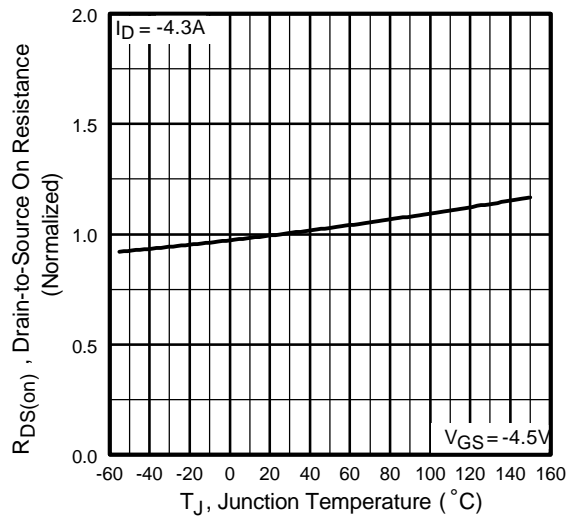
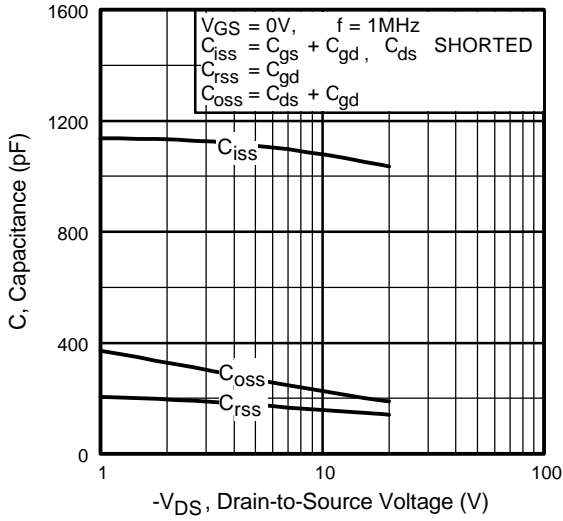
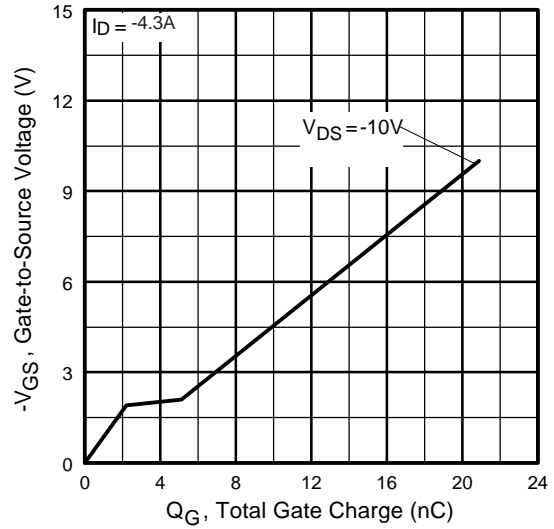

Fig 4. Normalized On-Resistance Vs. Temperature



**Fig 5.** Typical Capacitance Vs. Drain-to-Source Voltage



**Fig 6.** Typical Gate Charge Vs. Gate-to-Source Voltage

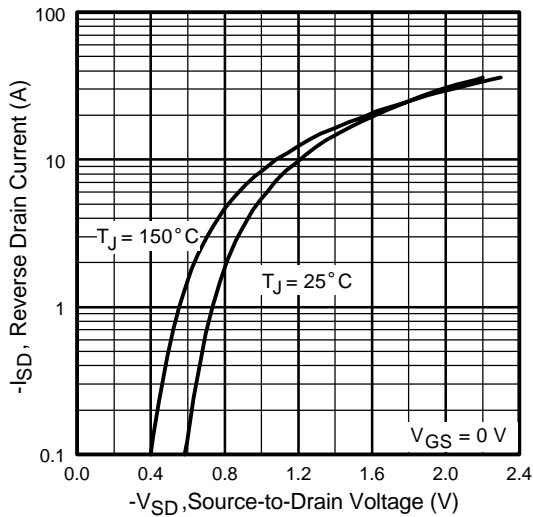

**Fig 7.** Typical Source-Drain Diode Forward Voltage

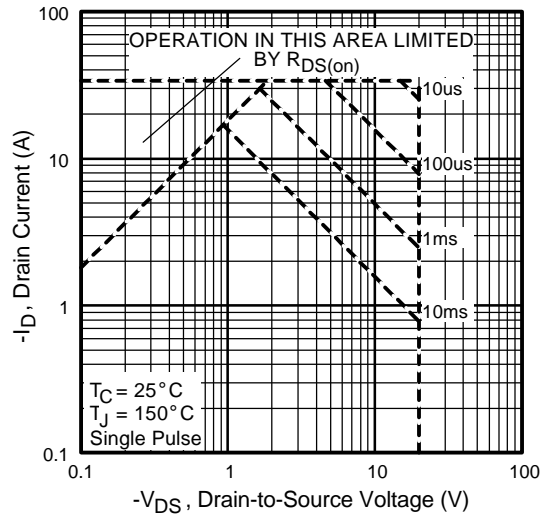

**Fig 8.** Maximum Safe Operating Area

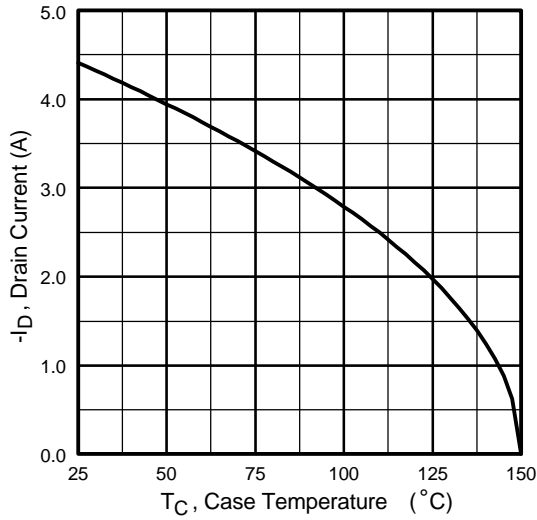

**Fig 9.** Maximum Drain Current Vs. Case Temperature

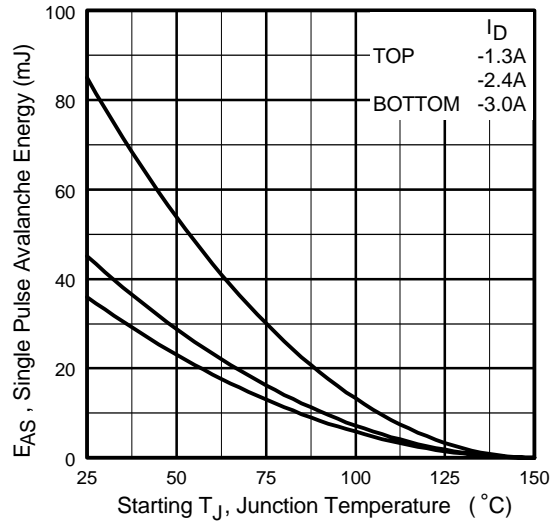

**Fig 10.** Maximum Avalanche Energy Vs. Drain Current

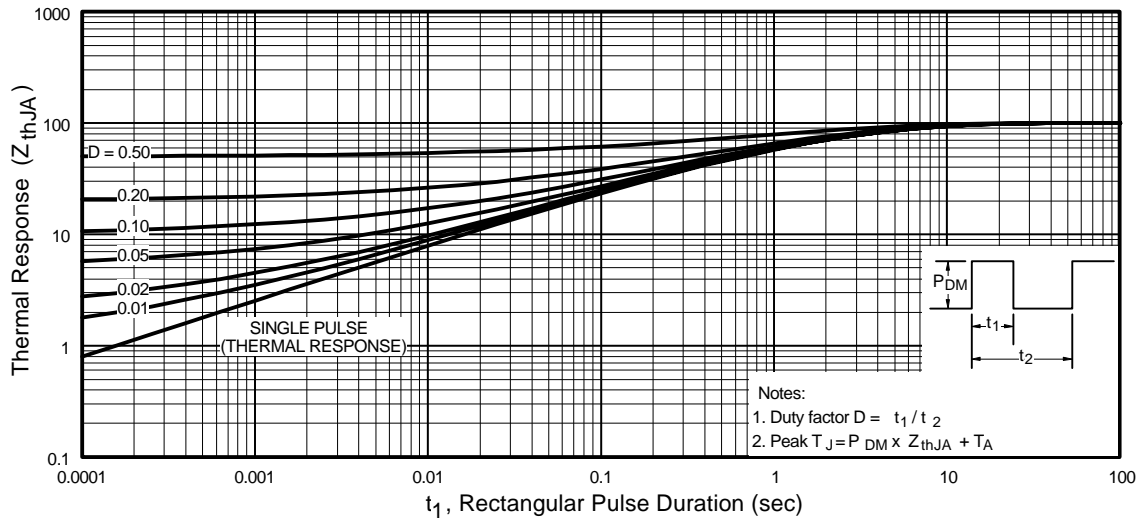

**Fig 11.** Maximum Effective Transient Thermal Impedance, Junction-to-Ambient

# IRF7555

## Package Outline

### Micro8™ Outline

Dimensions are shown in millimeters (inches)

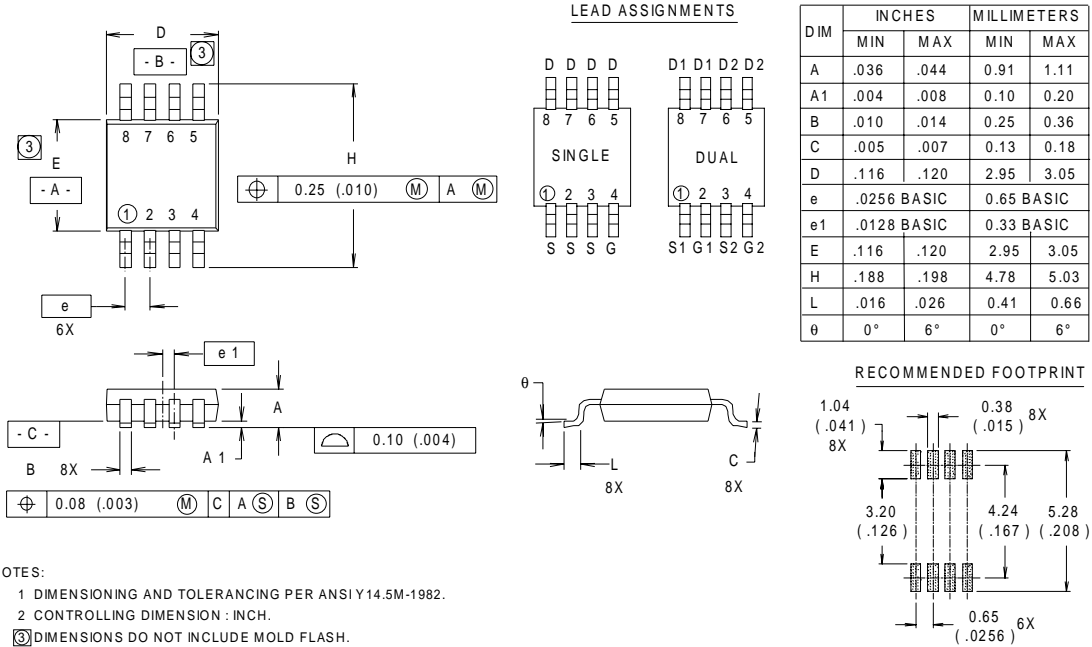

## Part Marking Information

### Micro8™

EXAMPLE : THIS IS AN IRF7501

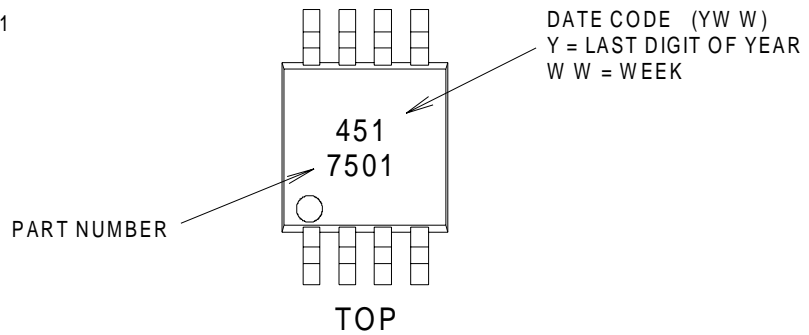

## Tape & Reel Information

### Micro8™

Dimensions are shown in millimeters (inches)

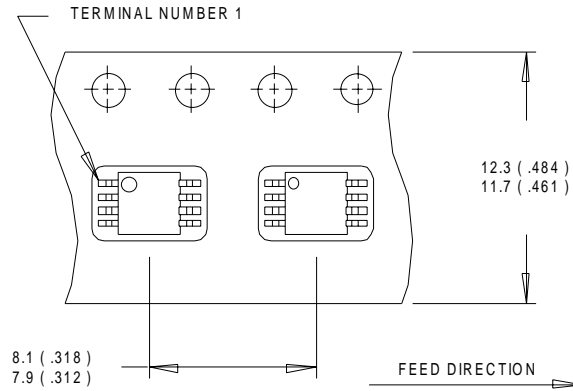

- NOTES:
1. OUTLINE CONFORMS TO EIA-481 & EIA-541.
  2. CONTROLLING DIMENSION : MILLIMETER.

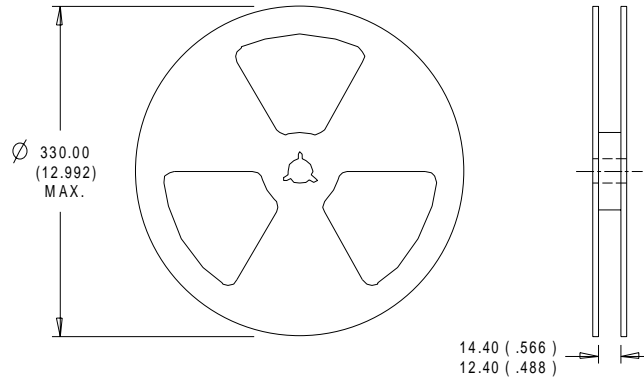

- NOTES:
1. CONTROLLING DIMENSION : MILLIMETER.
  2. OUTLINE CONFORMS TO EIA-481 & EIA-541.

**WORLD HEADQUARTERS:** 233 Kansas St., El Segundo, California 90245, Tel: (310) 252 7105

**IR GREAT BRITAIN:** Hurst Green, Oxted, Surrey RH8 9BB, UK Tel: ++ 44 1883 732020

**IR CANADA:** 15 Lincoln Court, Brampton, Ontario L6T3Z2, Tel: (905) 453 2200

**IR GERMANY:** Saalburgstrasse 157, 61350 Bad Homburg Tel: ++ 49 6172 96590

**IR ITALY:** Via Liguria 49, 10071 Borgaro, Torino Tel: ++ 39 11 451 0111

**IR JAPAN:** K&H Bldg., 2F, 30-4 Nishi-Ikebukuro 3-Chome, Toshima-Ku, Tokyo Japan 171 Tel: 81 3 3983 0086

**IR SOUTHEAST ASIA:** 1 Kim Seng Promenade, Great World City West Tower, 13-11, Singapore 237994 Tel: ++ 65 838 4630

**IR TAIWAN:** 16 Fl. Suite D. 207, Sec. 2, Tun Haw South Road, Taipei, 10673, Taiwan Tel: 886-2-2377-9936

*Data and specifications subject to change without notice. 2/2000*