

DATA SHEET

WIREWOUND RESISTORS

High Power
PNP Series

$\pm 1\%$, $\pm 5\%$

1W to 4W

RoHS compliant & Halogen Free



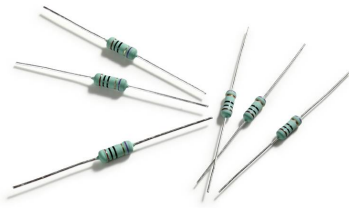

APPLICATIONS

- Power applications
- Home appliance
- Industry

FEATURES

- Ultra miniature size
- Wide resistance range
- Stable performance and high reliability
- Flameproof coating equivalent to UL-94V-0
- RoHS compliant & halogen free

ORDERING INFORMATION

Part number of the high power wirewound resistor are identified by the series, power rating, tolerance, packing, temperature coefficient, forming and resistance value.

PART NUMBER

PNP	200	F	I	F	73-	10R
(1)	(2)	(3)	(4)	(5)	(6)	(7)

(1) SERIES

PNP Series

(2) POWER RATING

100 = 1W	300 = 3W
200 = 2W	400 = 4W

(3) TOLERANCE

F = ±1%	J = ±5%
---------	---------

(4) PACKAGING TYPE

R = Reel Pack	B= Bulk
T= Box Pack	

(5) TEMPERATURE COEFFICIENT OF RESISTANCE

F=±100ppm/°C	- = Based on spec.
--------------	--------------------

(6) FORMING

52- = 52.4mm	FFK = F-form Kink
73- = 73mm	FKK = FKK Type
M = M-Type Forming	FT = FT Type Forming
MB = M-form W/flat	PN = PANAsert
F = F Type	AV = AVIsert
FK = FK Type	

(7) RESISTANCE VALUE

E24 & E96 Series
 Example:
 1R = 10Ω, 10R = 10Ω, 100R = 100Ω

DIMENSIONS

Unit: mm



Ultra Miniature	L	ψD	H	φd
PNP100	6.3 ± 0.5	2.5 ± 0.3	28 ± 2.0	0.55 ± 0.05
PNP200	9.0 ± 0.5	3.5 ± 0.3	26 ± 2.0	0.55 ± 0.05
PNP300	11.5 ± 1.0	4.6 ± 0.5	35 ± 2.0	0.8 ± 0.05
PNP400	15.5 ± 1.0	5.2 ± 0.5	33 ± 2.0	0.8 ± 0.05

DERATING CURVE

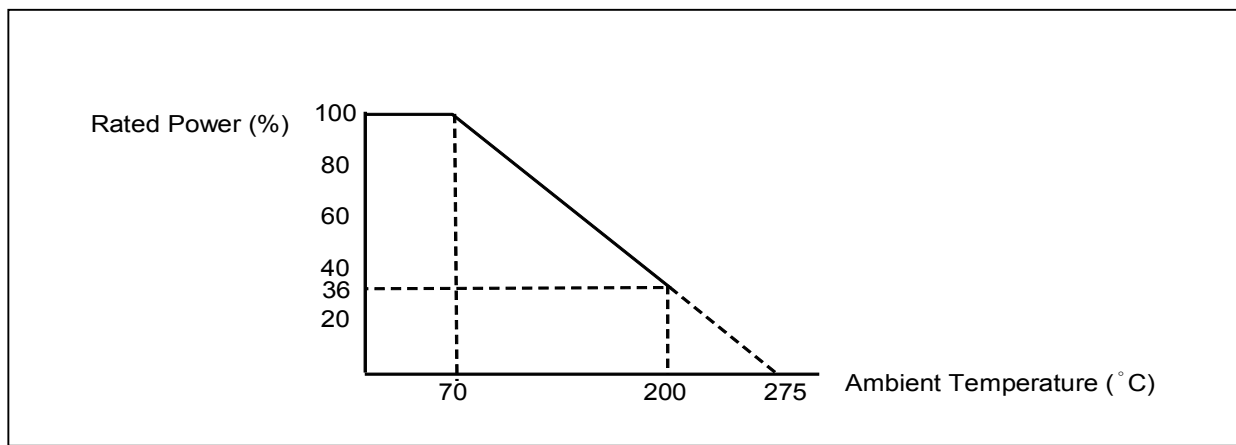

ELECTRICAL CHARACTERISTICS

CHARACTERISTICS	PNP100	PNP200	PNP300	PNP400
Power Rating at 70 °C	1W	2W	3W	4W
Resistance Range (±1%)	0.22Ω~130Ω	0.1Ω~820Ω	0.1Ω~2.2KΩ	0.1Ω~2.8KΩ
Resistance Range (±5%)	0.1Ω~130Ω	0.1Ω~820Ω	0.1Ω~2.2KΩ	0.1Ω~2.8KΩ
Voltage Proof on Insulation	300V			
Maximum working voltage	√(P X R)			
Operating Temp. Range	- 40°C to +200°C			
Temperature Coefficient	±100ppm/°C , ±100ppm/°C			

Note: For resistance value out of above range is by request.

TEST AND REQUIREMENTS

TEST	TEST METHOD	PROCEDURE	APPRAISE
Short Time Overload	IEC 60115-1 4.13	10 times rated power for 5 Sec.	±2%+0.05Ω
Voltage Proof on Insulation	IEC 60115-1 4.7	In V-Block for 60 sec. test voltage as above table	No Breakdown
Temperature Coefficient	IEC 60115-1 4.8	Between -40°C to +155°C	By Type
Insulation Resistance	IEC 60115-1 4.6	In V-Block for 60 sec.	>100MΩ
Solderability	IEC 60115-1 4.17	245±5°C for 3±0.5 Sec.	95% Min. coverage
Solvent Resistance of Marking	IEC 60115-1 4.30	IPA for 5±0.5 Min. with ultrasonic	No deterioration of coatings and markings
Robustness of Terminations	IEC 60115-1 4.16	Direct load for 10 Sec. in the direction of the terminal leads	≥2.5Kg(24.5N)
Damp Heat Steady State	IEC 60115-1 4.24	40±2°C,90-95% RH for 56 days, loaded with 0.1 times RCWV(or Umax., whichever less)	±5.0%+0.05Ω
Endurance at 70°C	IEC 60115-1 4.25	70±2°C at RCWV(or Umax., whichever less) for 1,000 Hr.(1.5 Hr.on,0.5 Hr. off)	±5.0%+0.05Ω
Temperature Cycling	IEC 60115-1 4.19	-55°C → Room Temp. → +200°C → Room Temp.(5 cycles)	±1.0%+0.05Ω
Resistance to Soldering Heat	IEC 60115-1 4.18	260±3°C for 10±1 Sec., immersed to a point 3±0.5mm from the body	±1.0%+0.05Ω
Accidental Overload Test	IEC 60115-1 4.26	4 times RCWV for 1 Min.	No evidence of flaming or arcing

Note:.

RCWV (Rated Continuous Working Voltage):

The DC or AC (rms) continuous working voltage corresponding to the rated power is determined by the following formula:

$$V=\sqrt{P \times R}$$

or max. working voltage whichever is less

Where

V=Continuous rated DC or AC (rms) working voltage (V)

P=Rated power (W)

R=Resistance value (Ω)

PULSE DIAGRAMS

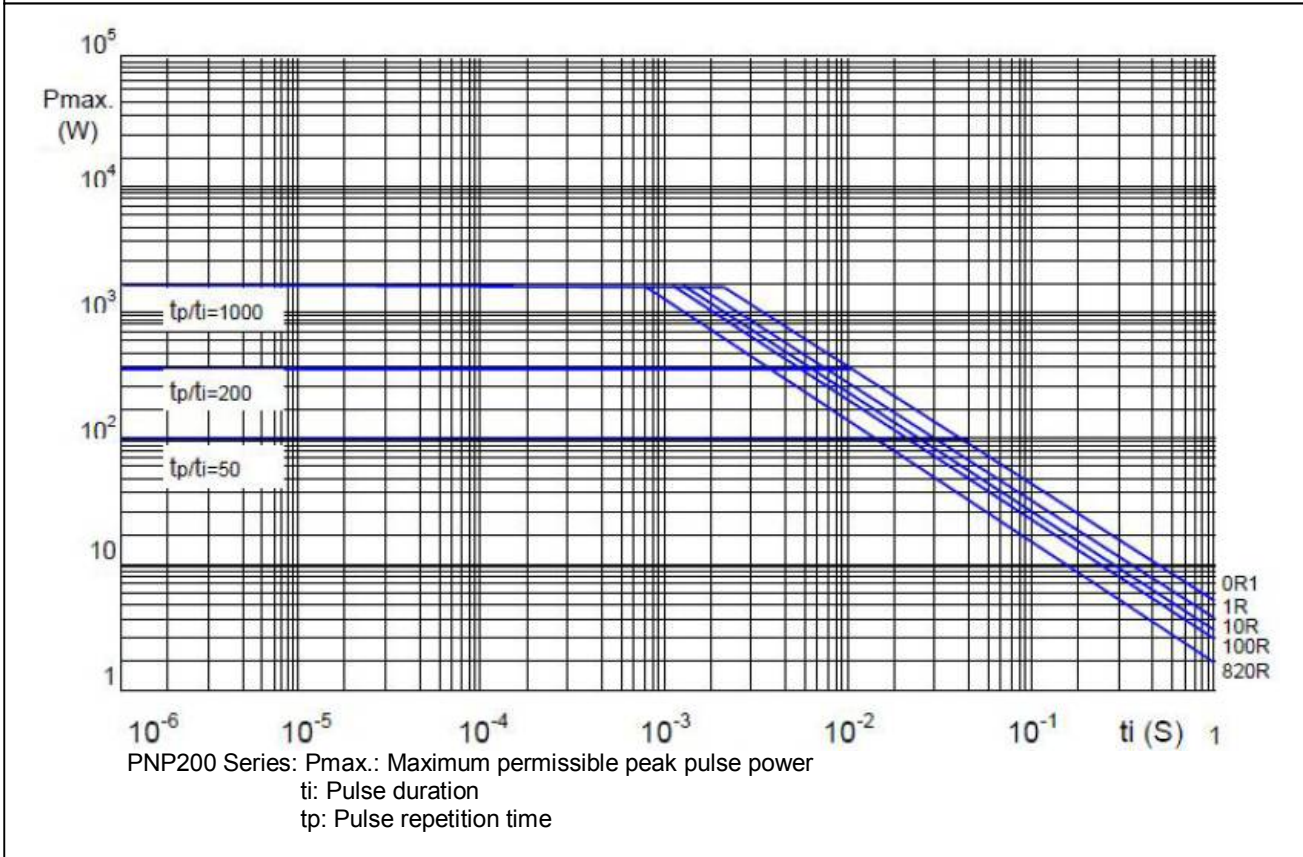
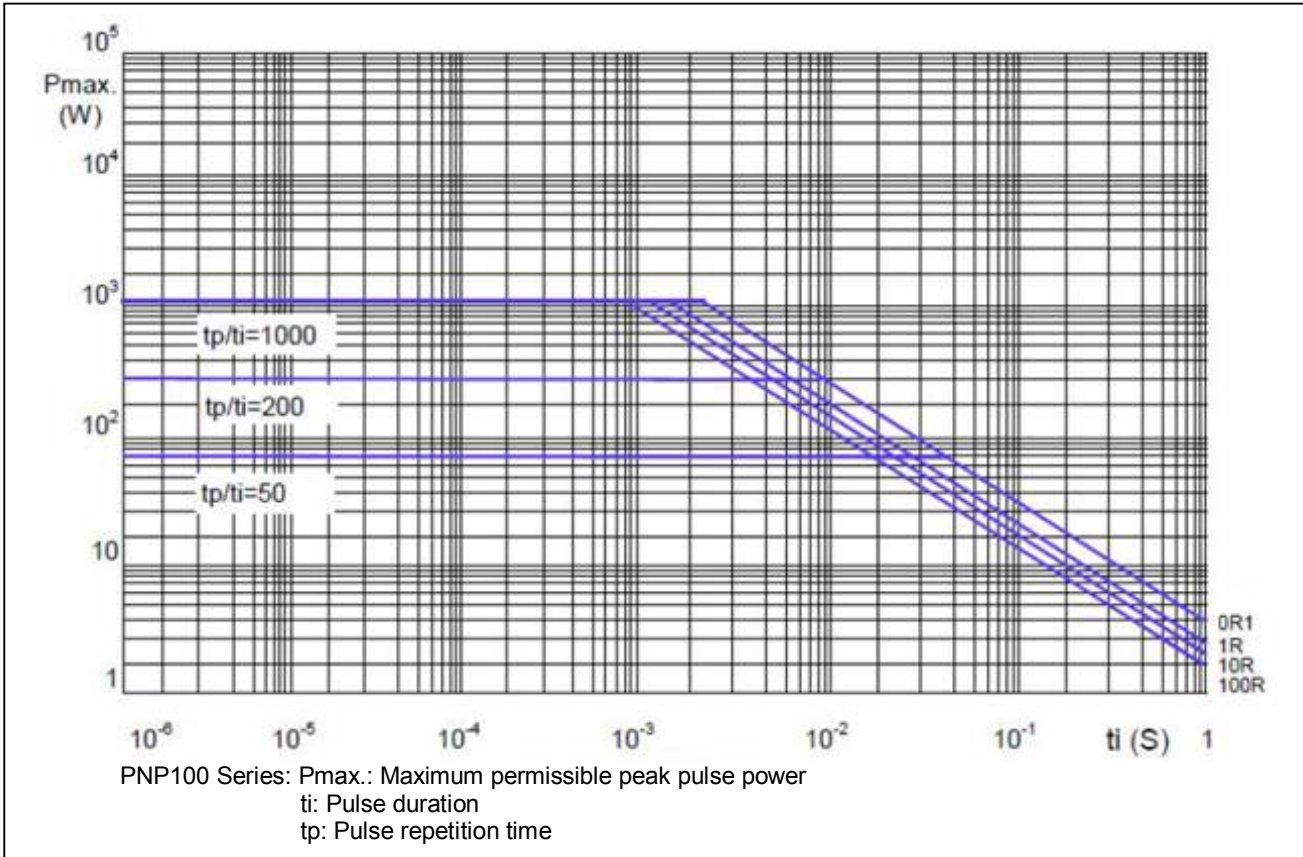

Wirewound Resistors

PNP

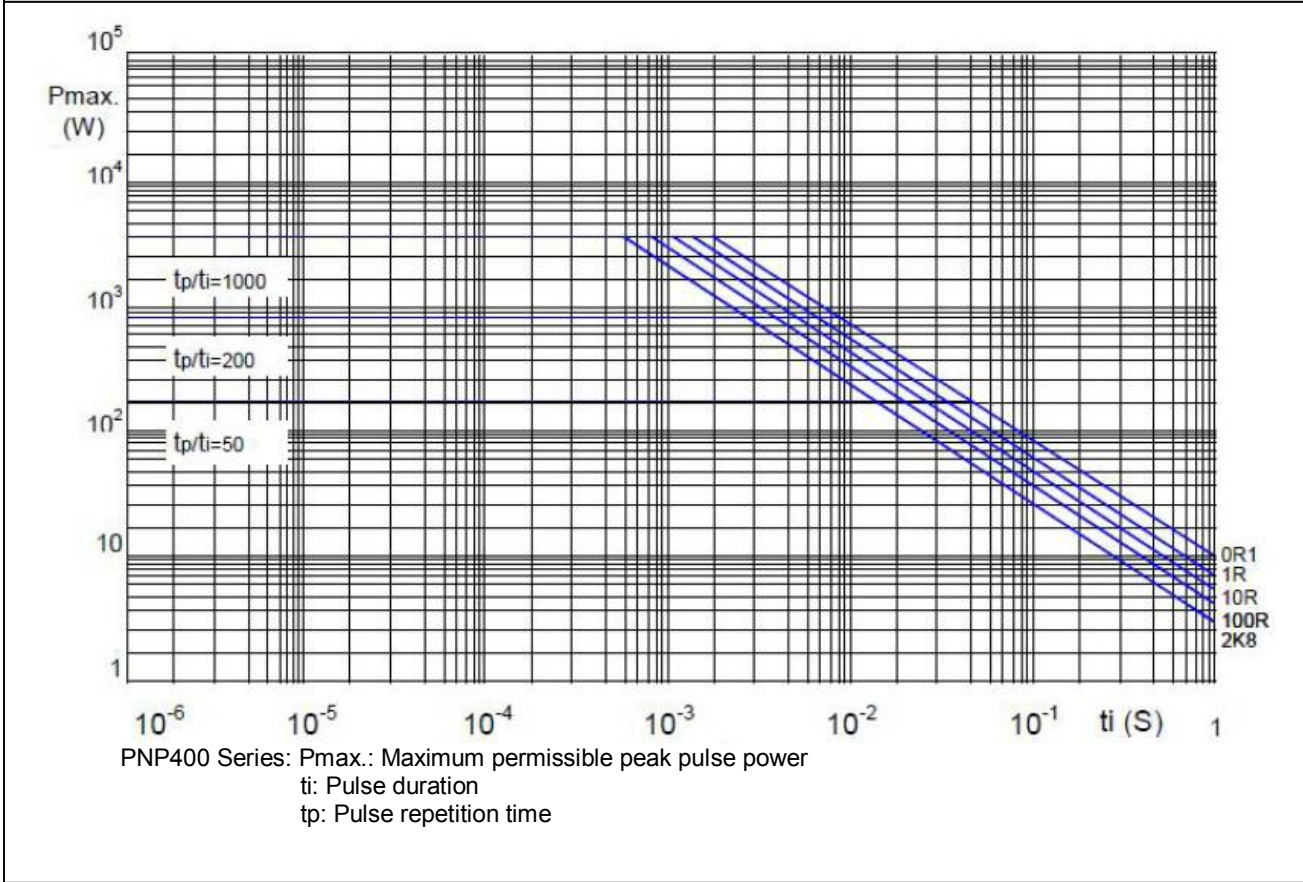
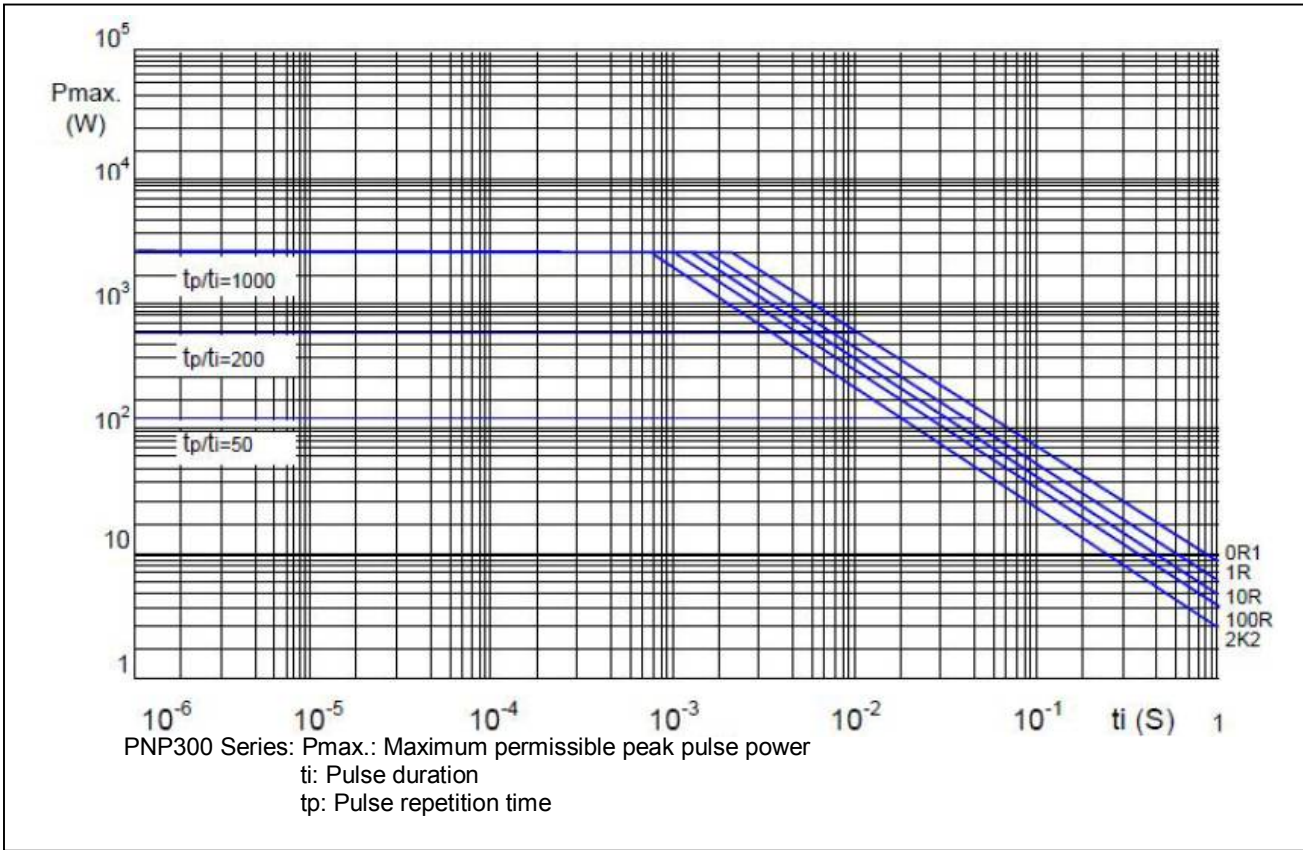

AXIAL / REEL TAPE SPECIFICATION

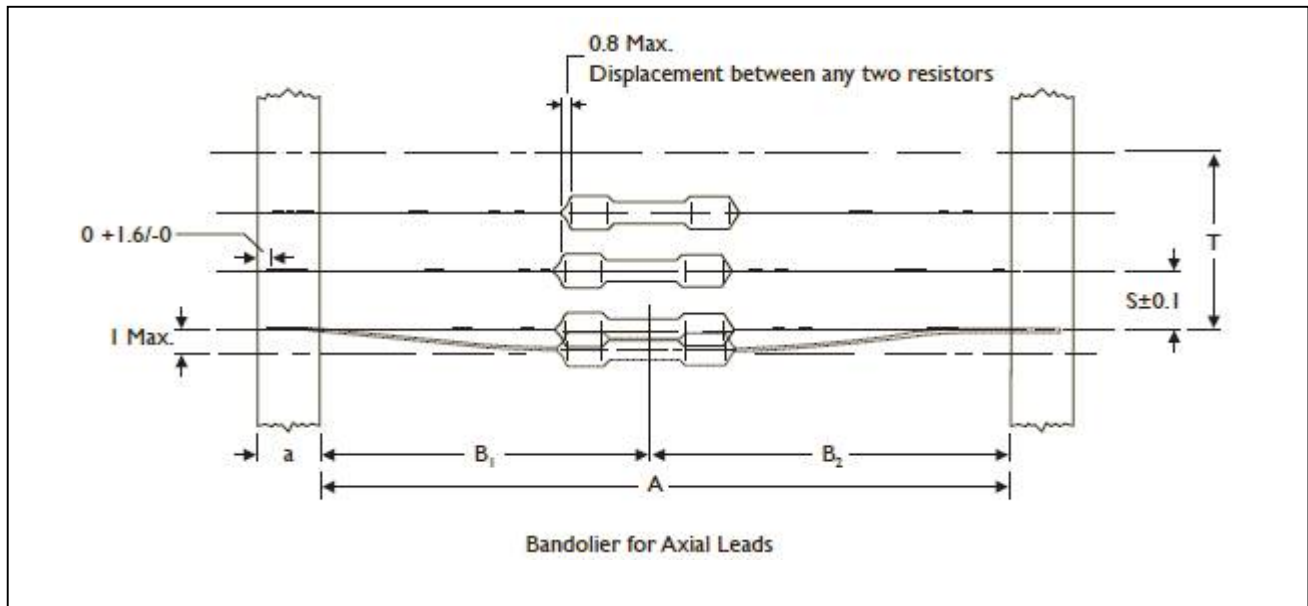

Unit: mm

Ultra Miniature	a	A	B1-B2 (Max.)	S (spacing)	T (max. deviation of spacing)
PNP100	6 ± 0.5	52.4 ± 1.5	1.2	5	
PNP200	6 ± 0.5	52.4 ± 1.5	1.2	5	
PNP300	6 ± 0.5	73.0 ± 1.5	1.5	5	1 mm per 10 spacing, 0.5 mm per 5 spacing
		52.4 ± 1.5	1.2		
PNP400	6 ± 0.5	73.0 ± 1.5	1.5	10	
		52.4 ± 1.5	1.2		

TAPE ON REEL PACKING

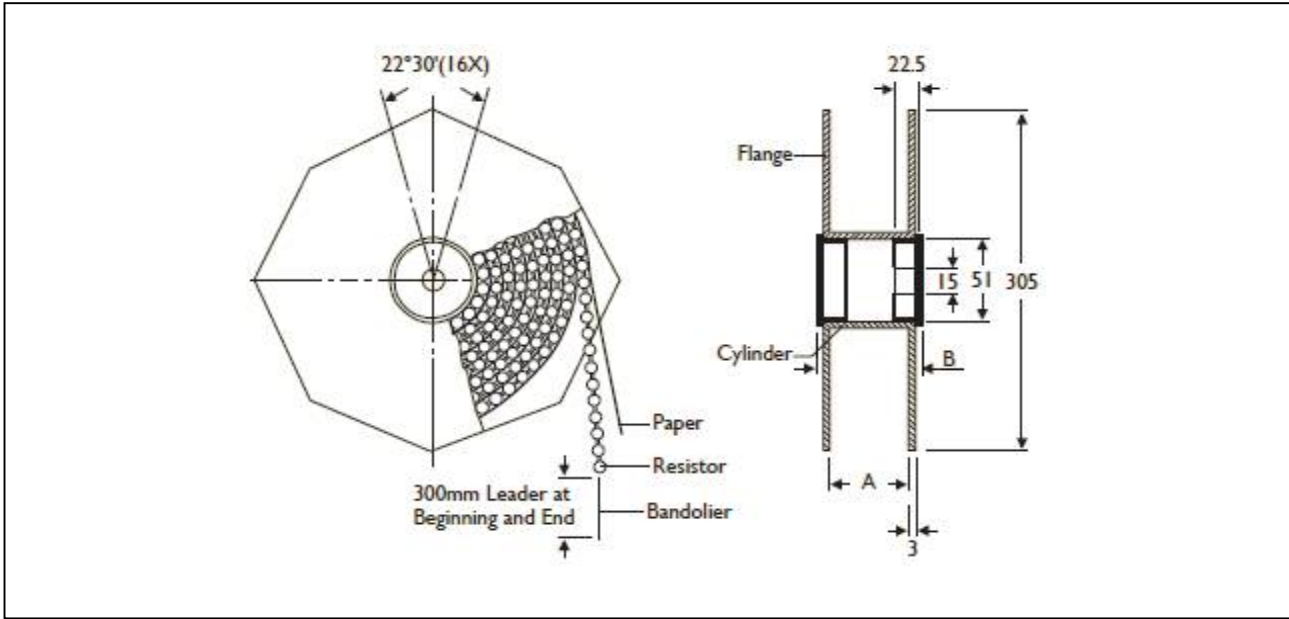

TYPE

Unit: mm/piece

Ultra Miniature	Across Flange(A)	B	Quantity Per Reel
PNP100	66.5	75.5	5,000
PNP200	66.5	75.5	2,500
PNP300	87	96	2,000
PNP400	87	96	1,000

TAPE ON BOX PACKING

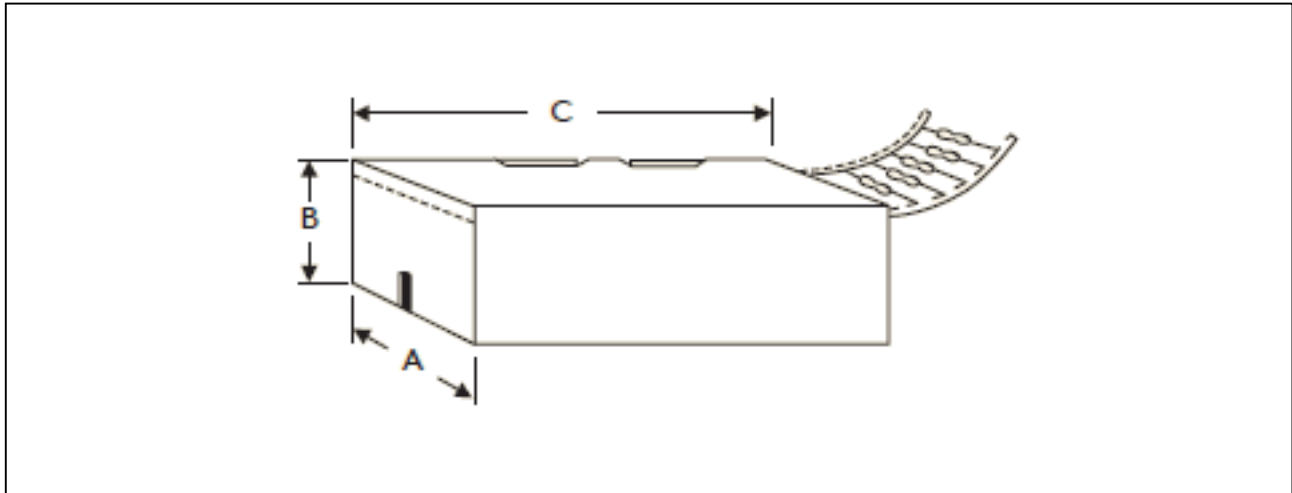

TYPE	DIMENSIONS			Unit: mm/piece
Ultra Miniature	A	B	C	Quantity Per Box
PNP100	81	104	260	5,000
PNP200	73	45	258	1,000
PNP300	81	91	260	1,000
PNP300	103	78	260	1,000
PNP400	81	91	260	1,000
PNP400	103	94	260	1,000

BULK PACKING

Ultra Miniature	Piece/Per Inner Box	Bag/Per Inner Box	Piece Per Bag
PNP100	10,000	10	1,000
PNP200	5,000	5	1,000
PNP300	2,000	4	500
PNP400	1,000	2	500

FORMING

M TYPE

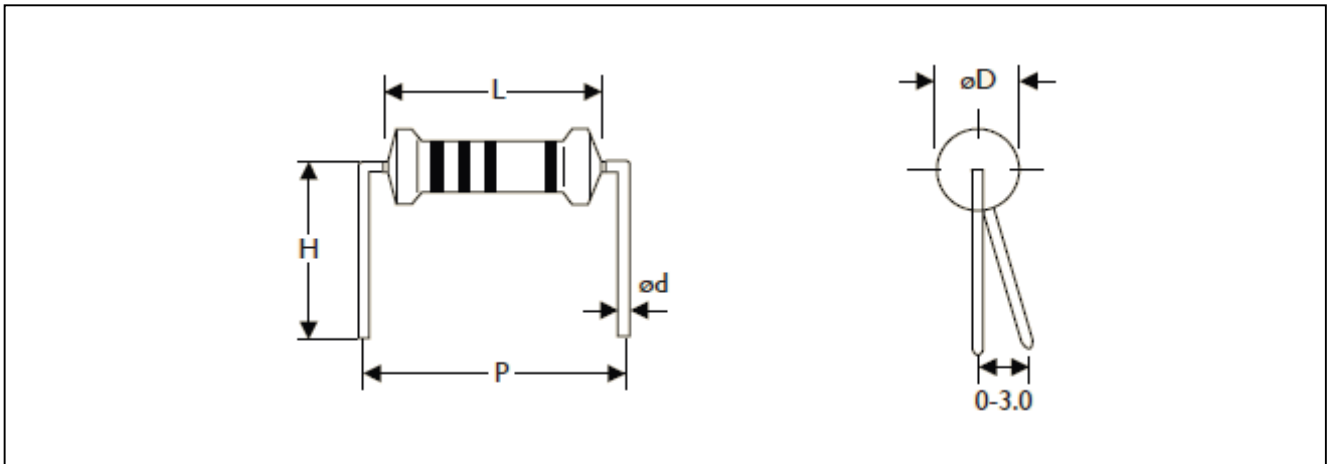

TYPE	DIMENSIONS					Unit: mm
Ultra Miniature	L	ψD	ψd	P	H	
PNP100	6.3 ± 0.5	2.5 ± 0.3	0.55 ± 0.05	10.0 ± 1	10.0 ± 1	
PNP200	9.0 ± 0.5	3.5 ± 0.3	0.55 ± 0.05	12.5 ± 1	10.0 ± 1	
PNP300	11.5 ± 1.0	4.6 ± 0.5	0.8 ± 0.05	15.0 ± 1	12.5 ± 1	
PNP400	15.5 ± 1.0	5.2 ± 0.5	0.8 ± 0.05	20.0 ± 1	15.0 ± 1	

MB TYPE

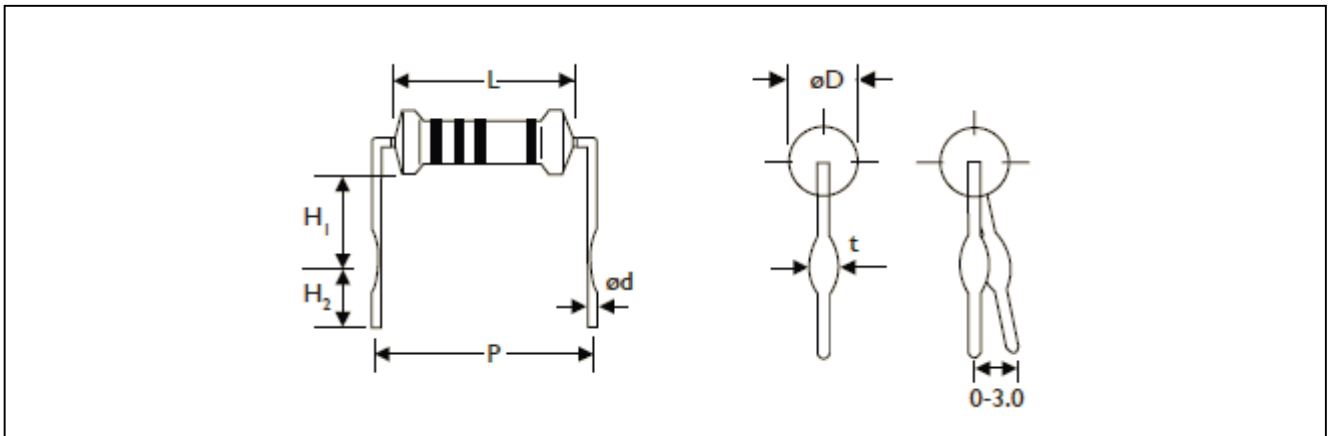

TYPE	DIMENSIONS							Unit: mm
Ultra Miniature	L	ψD	ψd	P	H1	H2	t	
PNP100	6.3 ± 0.5	2.5 ± 0.3	0.55 ± 0.05	10.0 ± 1	6.0 ± 1	5.0 ± 1	1.2 ± 0.2	
PNP200	9.0 ± 0.5	3.5 ± 0.3	0.8 ± 0.05	12.5 ± 1	6.0 ± 1	5.0 ± 1	1.4 ± 0.2	
PNP300	11.5 ± 1.0	4.6 ± 0.5	0.8 ± 0.05	15.0 ± 1	6.0 ± 1	5.0 ± 1	1.4 ± 0.2	
PNP400	15.5 ± 1.0	5.2 ± 0.5	0.8 ± 0.05	20.0 ± 1	10.0 ± 1	5.0 ± 1	1.4 ± 0.2	

MHA TYPE

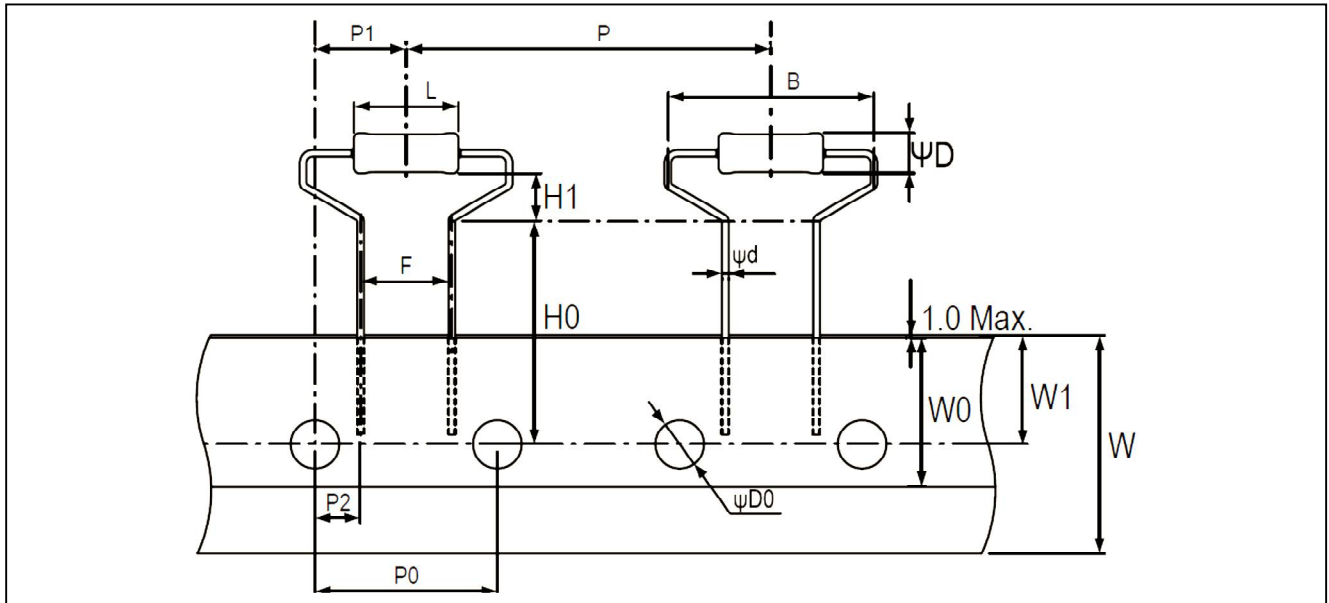

TYPE	DIMENSIONS							Unit: mm
Miniature	L	ψD	ψd	B	H0	H1	P	P0
	9.0±0.5	3.5±0.3	0.55±0.05	17.5Max	19.0±1.0	4.0±1.0	30.0±1.0	15.0±0.3
PNP200	P1	P2	F	W	W0	W1	ψD0	
	7.5±1.0	3.75±0.5	7.5±0.5	18.0±0.5	5.0Min	9.0±0.5	4.0±0.2	

MHB TYPE

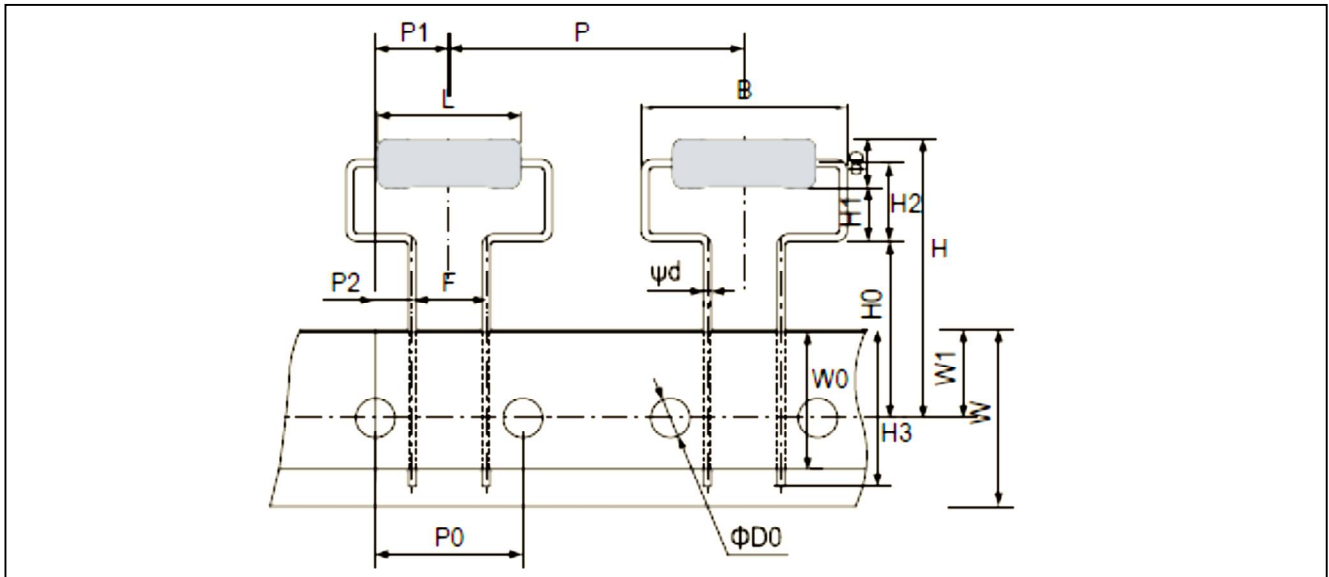

TYPE	DIMENSIONS									Unit: mm
Miniature	L	ψD	ψd	B	H	H0	H1	H2	H3	
	15.5±1.0	5.2±0.5	0.8±0.05	21.0Max.	30Max.	18.0±1.0	5.5(Ref.)	8.0±1.5	16Max.	
PNP400	P	P0	P1	P2	F	W	W0	W1	$\Psi D0$	
	30.0±1.0	15.0±0.3	7.5±1.0	3.75±0.8	7.5±0.5	18.0±0.5	5.0Min.	9.0±0.5	4.0±0.3	

MHC TYPE

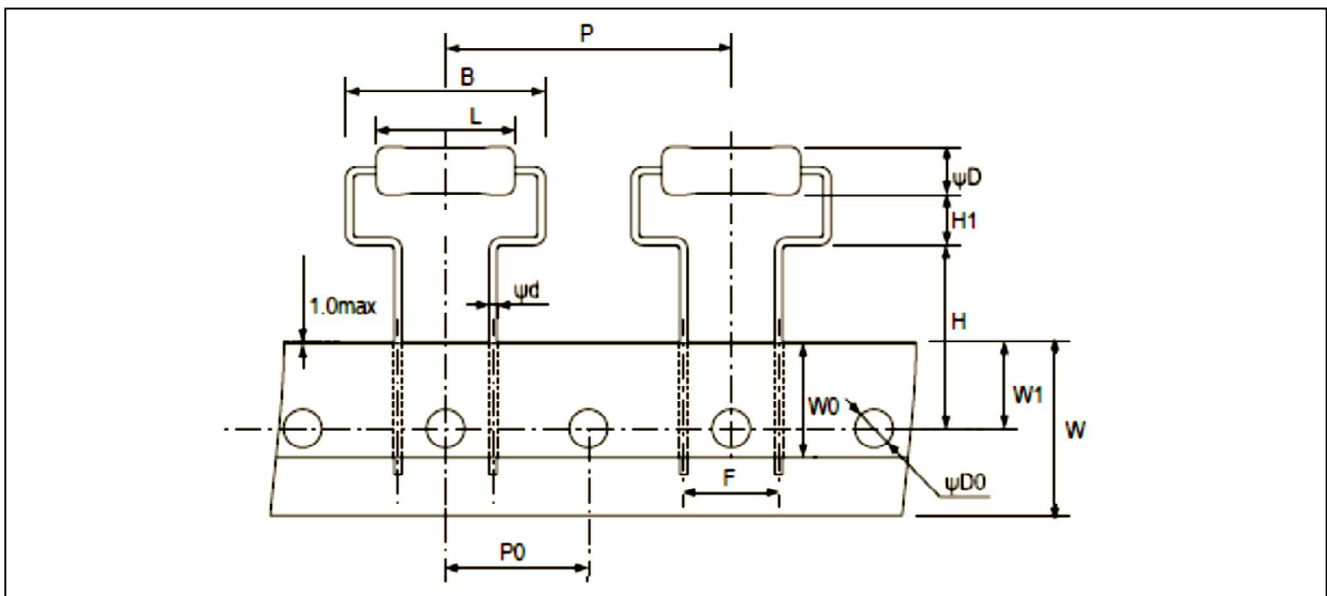

TYPE	DIMENSIONS									Unit: mm
Miniature	L	ψD	ψd	B	H	H1	P	P0		
	15.5±1.0	5.2±0.5	0.8±0.05	21.0Max.	19.0±1.0	5.25±1.0	30.0±1.0	15.0±0.3		
PNP400	F	W	W0	W1	$\Psi D0$					
	10.0±0.5	18.0±0.5	5.0Min.	9.0±0.5	4.0±0.2					

F TYPE

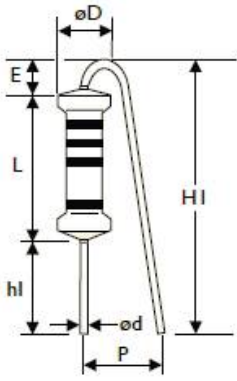

FK TYPE

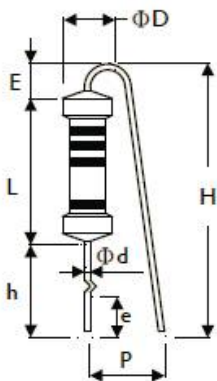

FFK TYPE

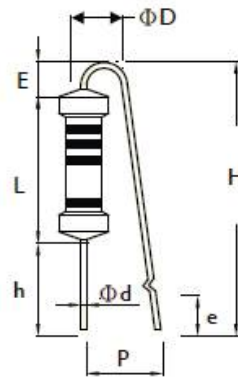

FKK TYPE

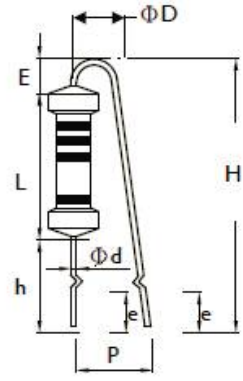

TYPE	DIMENSIONS										Unit: mm
Ultra Miniature	L	ψD	ψd	P	h	H Max.	hl	Hl Max.	E Max.	e	
PNP200	9.0±0.5	3.5±0.3	0.55±0.05	6±1	8±1	22	5±1	18.5	3.5	3.5±1	
PNP300	11.5±1	4.6±0.5	0.8±0.05	6±1	8±1	24	5±1	20	3.5	3.5±1	
PNP400	15.5±1	5.2±0.5	0.8±0.05	8±1	8±1	28	5±1	25	3.5	3.5±1	

PN TYPE (Taping Pack)

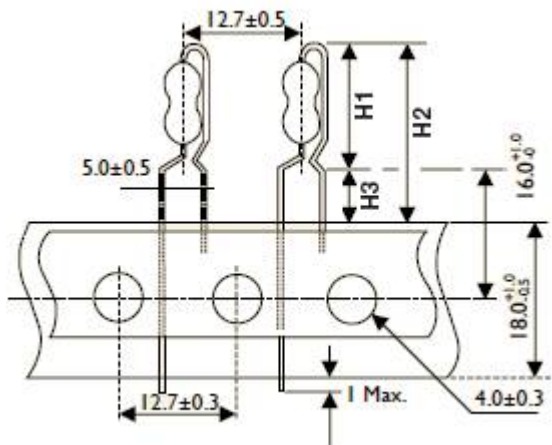

AV TYPE (Taping Pack)

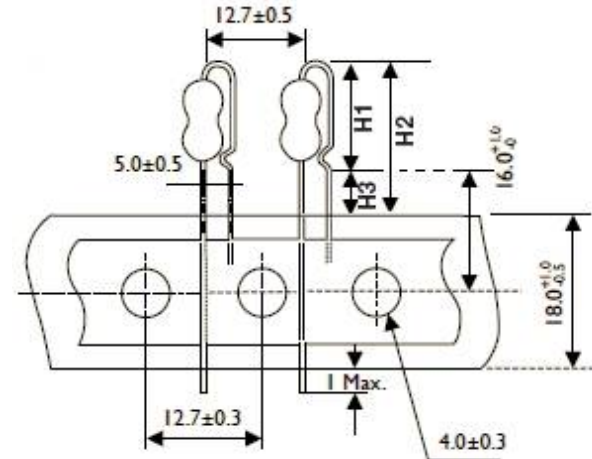

TYPE	DIMENSIONS			Unit: mm
Ultra Miniature	H1 Max.	H2 Max.	H3 Max.	
PNP100	13	21.5	8.5	
PNP200	17	25.5	8.5	
PNP300	19	27.5	8.5	

TYPE	DIMENSIONS			Unit: mm
Ultra Miniature	H1 Max.	H2 Max.	H3 Max.	
PNP100	11.5	20	8.5	
PNP200	14.5	23	8.5	
PNP300	17.5	26	8.5	

FT TYPE (Taping Pack)

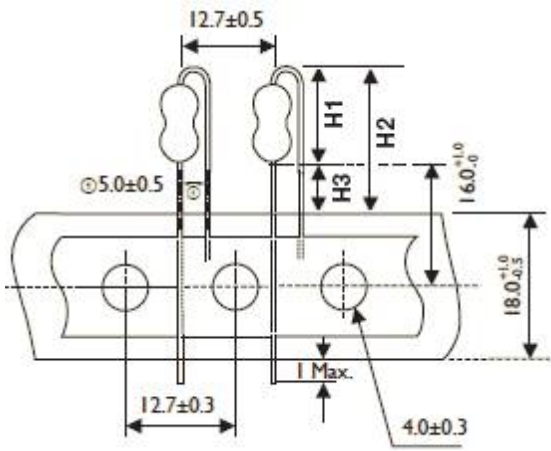

TYPE	DIMENSIONS			Unit: mm
	H1 Max.	H2 Max.	H3 Max.	
Ultra Miniature				
PNP100	10	18.5	8.5	
PNP200	13	21.5	8.5	
PNP300	16	24.5	8.5	

MARKING

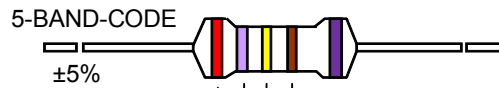

COLOR	1st BAND	2nd BAND	3rd BAND	MULTIPLIER	TOLERANCE
BLACK	0	0	0	1Ω	
BROWN	1	1	1	10Ω	± 1 % (F)
RED	2	2	2	100Ω	
ORANGE	3	3	3	1KΩ	
YELLOW	4	4	4	10KΩ	
GREEN	5	5	5	100KΩ	
BLUE	6	6	6	1MΩ	
VIOLET	7	7	7	10MΩ	PNP Series
GREY	8	8	8		
WHITE	9	9	9		
GOLD				0.1Ω	± 5 % (J)
SILVER				0.01Ω	

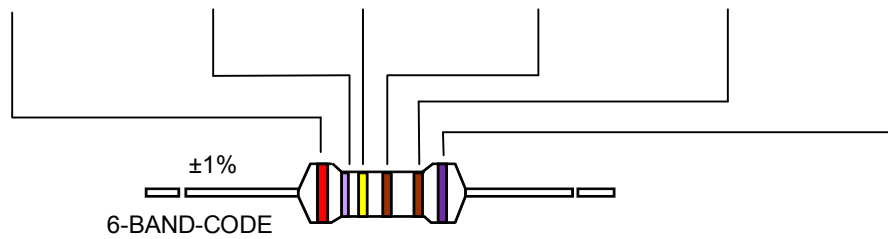

REVISION HISTORY

REVISION	DATE	CHANGE NOTIFICATION	DESCRIPTION
Version 0	Aug.2, 2021	-	- First issue of this specification

“ Yageo reserves all the rights for revising the content of this datasheet without further notification, as long as the products itse lf are unchanged. Any product change will be announced by PCN.”

LEGAL DISCLAIMER

Yageo, its distributors and agents (collectively, "Yageo"), hereby disclaims any and all liabilities for any errors, inaccuracies or incompleteness contained in any product related information, including but not limited to product specifications, datasheets, pictures and/or graphics. Yageo may make changes, modifications and/or improvements to product related information at any time and without notice.

Yageo makes no representation, warranty, and/or guarantee about the fitness of its products for any particular purpose or the continuing production of any of its products. To the maximum extent permitted by law, Yageo disclaims (i) any and all liability arising out of the application or use of any Yageo product, (ii) any and all liability, including without limitation special, consequential or incidental damages, and (iii) any and all implied warranties, including warranties of fitness for a particular purpose, non-infringement and merchantability.

Yageo statements regarding the suitability of products for certain types of applications are based on Yageo's knowledge of typical operating conditions for such types of applications in a generic nature. Such statements are neither binding statements of Yageo nor intended to constitute any warranty concerning the suitability for a specific customer application or use. They are intended for use only by customers with requisite knowledge and experience for determining whether Yageo products are the correct products for their application or use. In addition, unpredictable and isolated cases of product failure may still occur, therefore, customer application or use of Yageo products which requires higher degree of reliability or safety, shall employ additional protective safeguard measures to ensure that product failure would not result in personal injury or property damage.

Yageo products are not designed for application or use in medical, life-saving, or life-sustaining devices or for any other application or use in which the failure of Yageo products could result in personal injury or death. Customers using or selling Yageo products not expressly indicated for above-mentioned purposes shall do so at their own risk and agree to fully indemnify Yageo and hold Yageo harmless.

Information provided here is intended to indicate product specifications only. Yageo reserves all the rights for revising this content without further notification, as long as products are unchanged. Any product change will be announced by PCN.