

mangOH[®] Red

User Guide

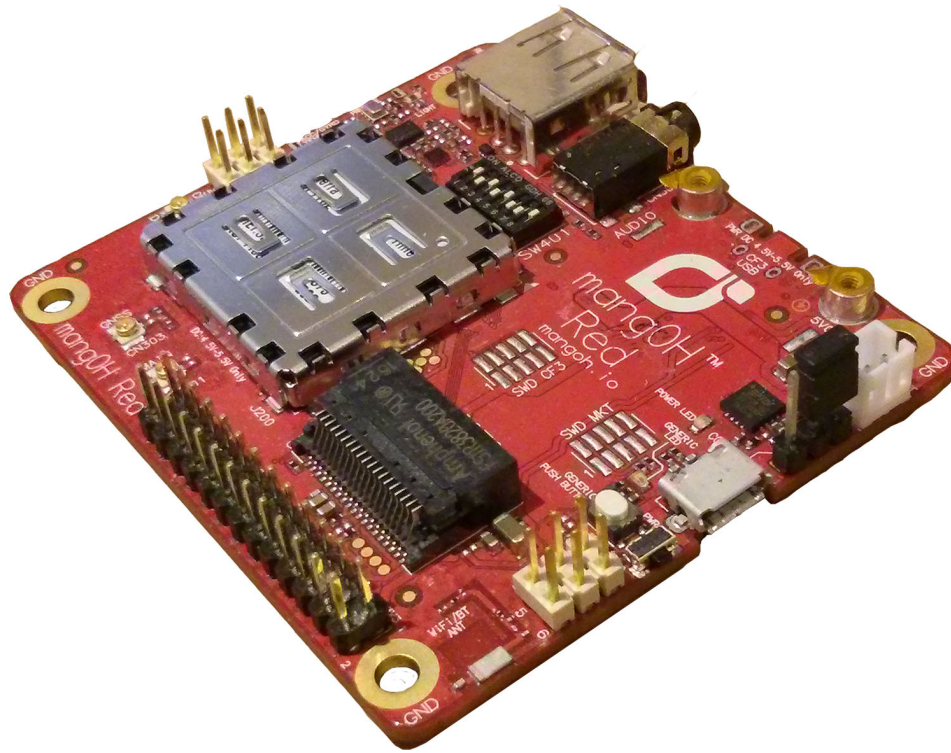

41110400

Rev 4

Contents subject to change

Important Notice

Due to the nature of wireless communications, transmission and reception of data can never be guaranteed. Data may be delayed, corrupted (i.e., have errors) or be totally lost. Although significant delays or losses of data are rare when wireless devices such as the Sierra Wireless modem are used in a normal manner with a well-constructed network, the Sierra Wireless modem should not be used in situations where failure to transmit or receive data could result in damage of any kind to the user or any other party, including but not limited to personal injury, death, or loss of property. Sierra Wireless accepts no responsibility for damages of any kind resulting from delays or errors in data transmitted or received using the Sierra Wireless modem, or for failure of the Sierra Wireless modem to transmit or receive such data.

Safety and Hazards

Do not operate the Sierra Wireless modem in areas where blasting is in progress, where explosive atmospheres may be present, near medical equipment, near life support equipment, or any equipment which may be susceptible to any form of radio interference. In such areas, the Sierra Wireless modem **MUST BE POWERED OFF**. The Sierra Wireless modem can transmit signals that could interfere with this equipment.

Do not operate the Sierra Wireless modem in any aircraft, whether the aircraft is on the ground or in flight. In aircraft, the Sierra Wireless modem **MUST BE POWERED OFF**. When operating, the Sierra Wireless modem can transmit signals that could interfere with various onboard systems.

Note: Some airlines may permit the use of cellular phones while the aircraft is on the ground and the door is open. Sierra Wireless modems may be used at this time.

The driver or operator of any vehicle should not operate the Sierra Wireless modem while in control of a vehicle. Doing so will detract from the driver or operator's control and operation of that vehicle. In some states and provinces, operating such communications devices while in control of a vehicle is an offence.

Limitation of Liability

The information in this manual is subject to change without notice and does not represent a commitment on the part of Sierra Wireless. SIERRA WIRELESS AND ITS AFFILIATES SPECIFICALLY DISCLAIM LIABILITY FOR ANY AND ALL DIRECT, INDIRECT, SPECIAL, GENERAL, INCIDENTAL, CONSEQUENTIAL, PUNITIVE OR EXEMPLARY DAMAGES INCLUDING, BUT NOT LIMITED TO, LOSS OF PROFITS OR REVENUE OR ANTICIPATED PROFITS OR REVENUE ARISING OUT OF THE USE OR INABILITY TO USE ANY SIERRA WIRELESS PRODUCT, EVEN IF SIERRA WIRELESS AND/OR ITS AFFILIATES HAS BEEN ADVISED OF THE POSSIBILITY OF SUCH DAMAGES OR THEY ARE FORESEEABLE OR FOR CLAIMS BY ANY THIRD PARTY.

Notwithstanding the foregoing, in no event shall Sierra Wireless and/or its affiliates aggregate liability arising under or in connection with the Sierra Wireless product, regardless of the number of events, occurrences, or claims giving rise to liability, be in excess of the price paid by the purchaser for the Sierra Wireless product.

Patents

This document contains information which is proprietary to Sierra Wireless Inc. and is licensed pursuant to Creative Commons Attribution 4.0 International License.

Document details

Title: mangOH Red User Guide

Author: Sierra Wireless

Source: <http://mangoh.io/>

Copyright

© 2020 Sierra Wireless. Licensed under the Creative Commons Attribution 4.0 license, <http://creativecommons.org/licenses/by/4.0/>



Disclaimer

Indicate any modifications made to the original document.

Trademarks

mangOH® and the mangOH logo are trademarks of Sierra Wireless.

Other trademarks are the property of their respective owners.

Revision History

Revision number	Release date	Changes
1	February 2017	Document created
2	May 2017	Removed DV2 references, updated to DV3 where needed
3	September 2018	Updated DV5 Updated Table 1-2 Added Console Access appendix
4	May 2020	Updated list of WP76xx modules

Contents

- Introduction 6**
 - mangOH Red Components and Accessories 6

- Setup and Installation 9**
 - Safe Handling Recommendations 9
 - Initial Setup 10

- Hardware Setup and Features 13**
 - Insert/Remove Embedded Module 13
 - Power Supply Sources. 15
 - Select USB Power Supply 15
 - Connect Battery Backup 16
 - Connect Antenna(s). 17
 - SIM, SD, and IoT Expansion Cards. 18
 - Inserting a micro-SIM Card 18
 - Inserting a microSD Card. 20
 - Inserting/Removing an IoT Expansion Card 21
 - Peripheral Connectors 23
 - Raspberry Pi Connector 23
 - Audio Connection 24
 - USB Host Connection 24
 - Control Connections 25
 - Console USB Connector 25
 - CF3 USB Connection 25
 - LED Indicators 27
 - Physical Switches 29
 - Reset Switches 29
 - Buttons 29

mangOH Red Configuration	30
Default Configuration	30
Switch and Jumper Configuration Options	31
Real-time I/O	31
Low-power I/O	32
Module Signals Control	32
Software Setup	36
Install / Update Windows Driver.	36
Install a Terminal Emulator	37
Download Firmware Updates.	37
Write Your First Program	38
Console Access.	39

1: Introduction

This user guide explains how to set up and begin using the mangOH[®] Red with CF3 (Common Flexible Form Factor) modules.

Once you have the mangOH Red set up, visit mangoh.io/mangoh-red-resources for developer documentation, code samples, and other materials.

1.1 mangOH Red Components and Accessories

Table 1-1 details the required and optional components needed to begin using the mangOH Red in your development environment. Some of these components are available in mangOH Red development kits (kit contents are supplier-dependent).

Table 1-1: mangOH Red Required and Optional Components







Item	Details	Example
(1) mangOH Red with CF3 module (Pre-installed in kit)	<p>Pre-configured development board for CF3 modules</p> <p>The module in the kit includes a cellular modem and an application processor running Legato, an open source embedded platform built on Linux for hosting IoT applications (see legato.io for details).</p> <p>For a list of Sierra Wireless CF3 modules and their compatibility with mangOH Red, see Table 1-2 on page 7.</p> <p>Note: <i>Not all supported Sierra Wireless modules include application processors.</i></p>	
(2) CF3 module covers and cover removal tool (One pre-installed in kit)	<p>Industrial-quality snap-in module covers (for 2.5 mm and 4.0 mm height modules) plus cover removal tool to disconnect the cover from the mangOH Red</p> <p>Note: <i>The cover and tool shown are for WP-series modules. A similar cover and tool (not displayed) are used for HL-series modules.</i></p>	
(2) Micro-USB cables (Included in kit)	<p>Connects computer to the mangOH Red for communication and to provide power for non-transmitting tests.</p>	
(1 or 2) Antenna, Ultra Wide Band (Included in kit)	<p>Main RF antenna included. Second antenna included if CF3 module supports diversity.</p>	

Table 1-1: mangOH Red Required and Optional Components (Continued)

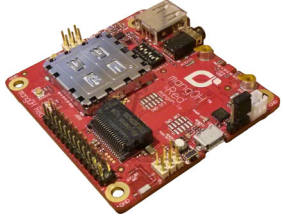
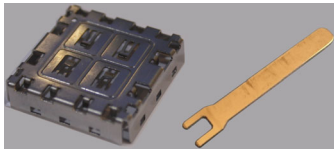
Item	Details	Example
(1) GNSS Antenna (Included in kit)	Antenna may be connected for GNSS reception.	
(1) micro-SIM card (Included in kit)	<ul style="list-style-type: none"> Sierra Wireless or AT&T micro-SIM card (included) with initial data allocation, or User-provided micro-SIM with an active account, or User-provided test card for use with a call box. 	
M2 screws (Included in kit)	Two M2 screws included for IoT card installation	
Audio cable (3.5 mm) (Not included in kit)	Optional audio cable or headset	

The mangOH Red schematic (available at mangoh.io/mangoh-red-resources-hardware), describes all interfaces supported by the mangOH Red.

The following table identifies differences between mangOH Red interfaces, the CF3 standard, and WP Series modules. Refer to source.sierrawireless.com for module-specific Product Technical Specification Documents.

Table 1-2: Interface Variations (mangOH vs CF3 Specification vs WP Series Modules)^a

Pin	Signal Names				
	mangOH	CF3	WP85/75 ^b	WP76xx ^c	WP77xx ^d
2	NC	UART1_RI	UART1_RI	UART1_RI	UART1_RI
7	NC	UART1_DTR	UART1_DTR	UART1_DTR	UART1_DTR
8	NC	UART1_DCD	UART1_DCD	UART1_DCD	UART1_DCD
9	NC	UART1_DSR	UART1_DSR	UART1_DSR	UART1_DSR
10	GPIO_IOT0_RESET	GPIO2	GPIO2	GPIO2	GPIO2
11	RESET_IN_CF3	RESET_IN_N	RESET_IN_N	RESET_IN_N	RESET_IN_N
21	BAT_RTC	BAT_RTC	BAT_RTC	Reserved	Reserved
31	RF_DIV	RF_DIV	(WP75) RF_DIV (WP85) Reserved	RF_DIV	Reserved
40	IOT0_GPIO3	GPIO7	GPIO7	GPIO7	GPIO7
41	IOT0_GPIO4	GPIO8	GPIO8	GPIO8	GPIO8
42	PPS	DR_SYNC	DR_SYNC	DR_SYNC	DR_SYNC
43	PWM_OUT	EXT_GPS_LNA_EN	Reserved	EXT_GPS_LNA_EN	EXT_GPS_LNA_EN
44	IOT0_GPIO2	GPIO13	GPIO13	GPIO13	GPIO13

Table 1-2: Interface Variations (mangOH vs CF3 Specification vs WP Series Modules)^a

Pin	Signal Names				
	mangOH	CF3	WP85/75 ^b	WP76xx ^c	WP77xx ^d
46	LowPower_RESET	RESET_OUT_N	RESET_OUT_N	RESET_OUT_N	RESET_OUT_N
55	UIM2_VCC	UIM2_VCC	UIM2_VCC	Reserved	Reserved
56	UIM2_DAT	UIM2_DAT	UIM2_DATA	Reserved	Reserved
57	UIM2_RST	UIM2_RST	UIM2_RESET_N	Reserved	Reserved
58	UIM2_CLK	UIM2_CLK	UIM2_CLK	Reserved	Reserved
65	UIM2_DET	UIM2_DET	UIM2_DET	GPIO4	GPIO4
92	WP_GPIO_4_wakeable	SPI2CLK	GPIO38	GPIO38	GPIO38
93	NC	SPI2_MOSI	GPIO39	Reserved	Reserved
94	NC	SPI2_MISO	GPIO40	GPIO40	GPIO40
95	NC	SPI2_CS0	GPIO41	GPIO41	GPIO41
98	UART2_RTS	UART2_RTS	Reserved	UART2_RTS	UART2_RTS
99	UART2_CTS	UART2_CTS	Reserved	UART2_CTS	UART2_CTS
100	WP_GPIO_7	GPIO34	GPIO34	Reserved	Reserved
101	WP_GPIO_8	GPIO35	GPIO35	GPIO35	GPIO35
102	WP_GPIO_5_wakeable	GPIO36	GPIO36	GPIO36	GPIO36
103	NC	GPIO37	GPIO37	GPIO37	GPIO37
104	GPIOEXP_INT1	GPIO32	GPIO32	GPIO32	GPIO32
105	CARD_DETECT_IOT0	GPIO33	GPIO33	GPIO33	GPIO33
109	IOT0_GPIO1	GPIO42	GPIO42	GPIO42	GPIO42
147	SPI2_SRDY_WIFI_1V8	GPIO21	GPIO21	GPIO21	GPIO21
148	WP_GPIO_1	GPIO22	GPIO22	GPIO22	GPIO22
149	WP_GPIO_2	GPIO23	GPIO23	GPIO23	GPIO23
150	WP_GPIO_3	GPIO24	GPIO24	GPIO24	GPIO24
152	NC	SAFE_PWR_REMOVE	SAFE_PWR_REMOVE	SAFE_PWR_REMOVE	SAFE_PWR_REMOVE
153	NC	ANT_CTL_0	ANT_CNTL0/GPIO28	ANT_CNTL0	ANT_CNTL0
154	NC	ANT_CTL_1	ANT_CNTL1/GPIO29	ANT_CNTL1	ANT_CNTL1
155	NC	ANT_CTL_2	ANT_CNTL2/GPIO30	ANT_CNTL2	ANT_CNTL2
156	NC	ANT_CTL_3	ANG_CNTRL3/GPIO31	ANT_CNTL3	ANT_CNTL3

a. Refer to Product Technical Specification documents for detailed module information.
 b. WP85/75=WP8548, WP7502, WP7504
 c. WP76xx=WP7601/WP7601-1, WP7603/WP7603-1, WP7605, WP7607/WP7607-1, WP7608/WP7608-1, WP7609, WP7610, WP7611/WP7611-1
 d. WP77xx=WP7700, WP7702

2: Setup and Installation

2.2 Safe Handling Recommendations

To help prevent accidental damage to the mangOH Red:

- Use safe ESD-handling practices (such as wearing proper ESD straps) to avoid possible ESD damage.
- The mangOH Red kit comes with the CF3 module and cover pre-installed. If you remove the module, avoid touching the CF3 module socket (J200). These pins can be damaged if caught on clothing or other materials.

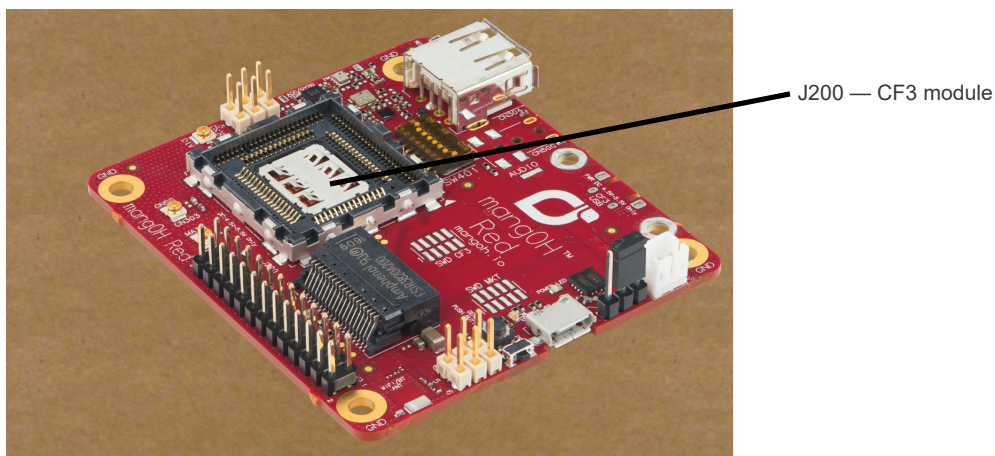

Figure 2-1: Safe Handling Recommendations—CF3 Socket (Do Not Touch)

- Optionally, attach standoffs (not included) to the mounting holes at each corner of the board to avoid damage to components on the bottom side of the board.

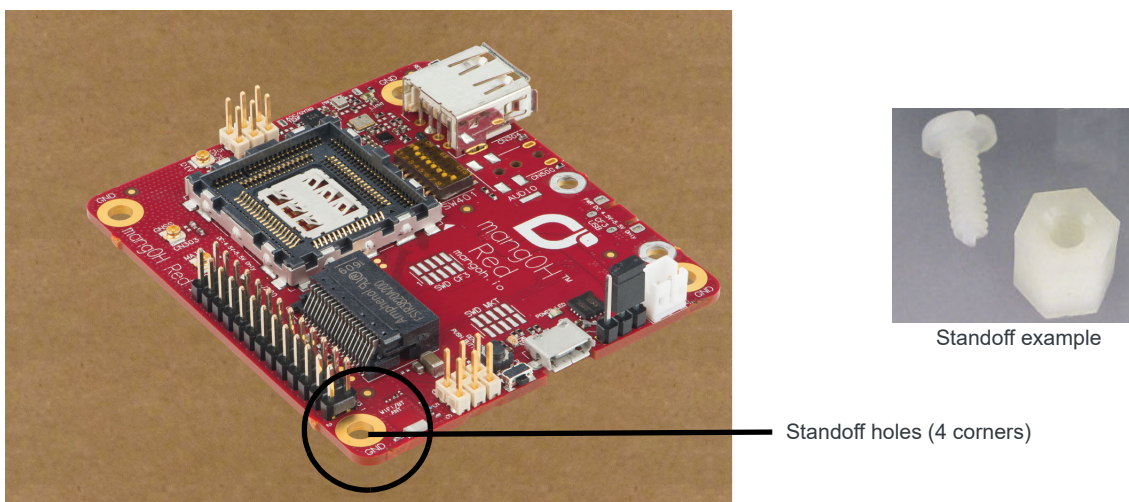

Figure 2-2: Module Standoff Placement

2.3 Initial Setup

To begin using the mangOH Red, set up your hardware and software:

1. [Install / Update Windows Driver](#). See page 36.
2. [Install a Terminal Emulator](#). See page 37.
3. Verify the SW401 dipswitch pins are set correctly:
 - a. If the dipswitches are covered with a protective film, remove it:

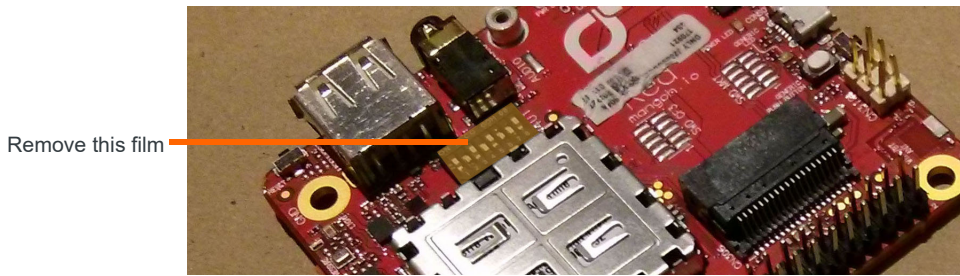

Figure 2-3: SW401 Dipswitch Location

- b. Make sure the dipswitches are set as follows:
 - ON—1,3,5,8
 - OFF—2,4,6,7

Note: Pin 1 must be ON to allow the module to power up as soon as power is supplied. If pin 1 is OFF, you must press SW402 after power is supplied to power up the module.

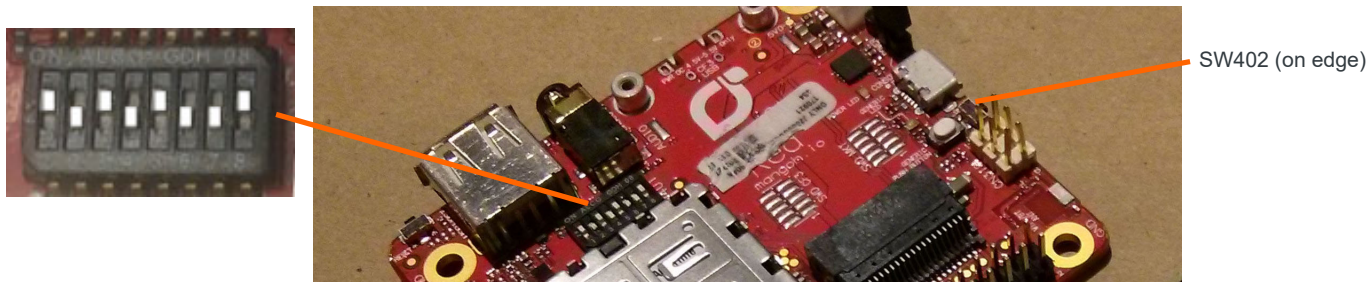

Figure 2-4: SW401 Dipswitch Recommended Settings

4. If you will be establishing a mobile network connection, insert a micro-SIM. See [Inserting a micro-SIM Card](#) on page 18.
5. [Connect Antenna\(s\)](#). See page 17.
6. [Select USB Power Supply](#). See page 15.

7. Power up the mangOH Red:

- a. Use a micro-USB cable to connect the mangOH Red USB connector that you selected as the power supply in [Step 6](#), and plug the other into your computer or AC adapter.

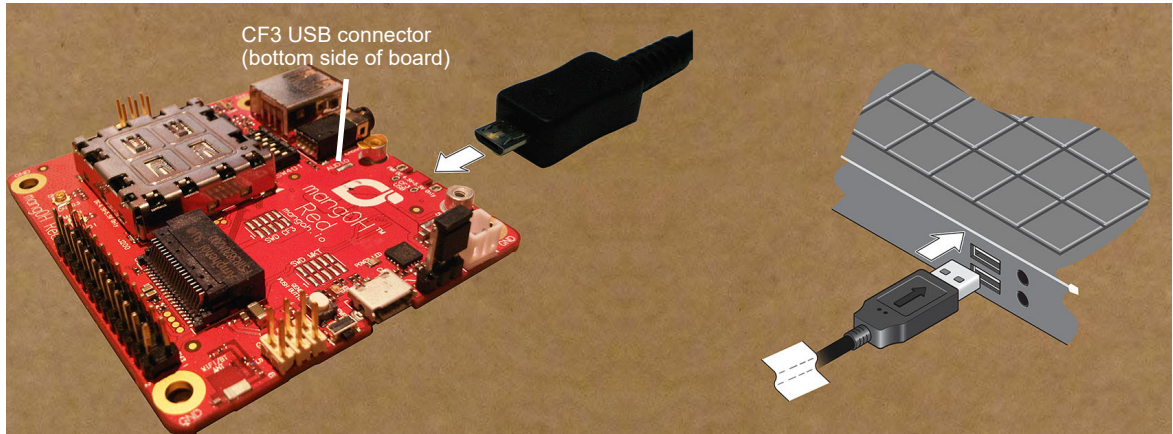

Figure 2-5: Connecting Power to the mangOH Red

When the mangOH Red is powered, the Power LED turns solid green.

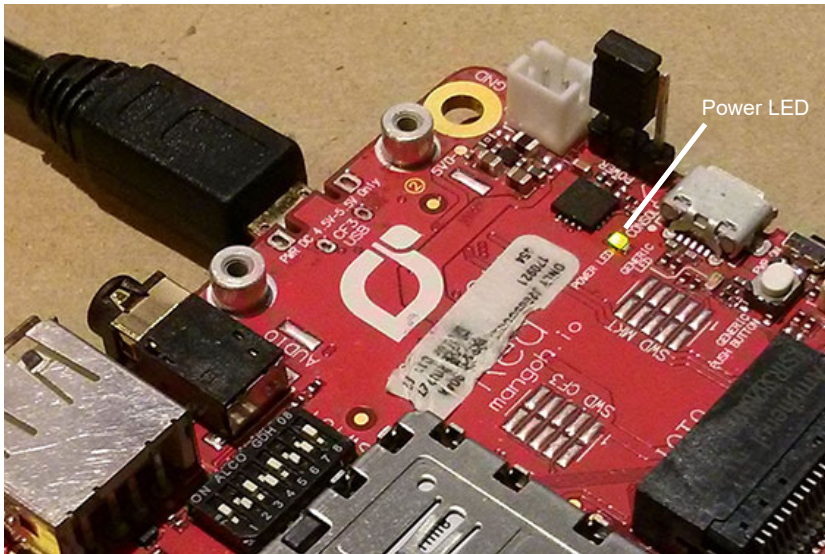

Figure 2-6: Power LED Location

Tip: If the Power LED does not turn on:

- Make sure the cable is securely connected to the correct USB port (as shown in the image).
- Make sure the jumper block is on the correct pins (as shown in the image).

- 8. Optionally (only if power is supplied from the computer, not an AC adapter), use a second mini-USB cable to connect the remaining mangOH Red USB connector (CF3 USB or Console) to your computer. (This enables you to display diagnostic messages in one terminal window and work in another, as described in [Console Access on page 39](#).)

The mangOH Red is now ready to be used.

- For information on additional hardware features, see [Hardware Setup and Features](#) on page 13.
- For instructions on writing a program, see [Write Your First Program](#) on page 38.

3: Hardware Setup and Features

This chapter describes:

- How to install various components on the mangOH Red
- Available connectors
- How to configure and control features using connectors and switches

3.4 Insert/Remove Embedded Module

The mangOH Red has one CF3 module socket. (For a list of supported Sierra Wireless CF3 modules, see [Table 1-2](#) on page 7.)

Note: The mangOH Red comes with a CF3 module (WP76xx, WP77xx, WP8548, etc.) pre-installed.

To insert a CF3 module on the mangOH Red board:

1. Place the mangOH Red face-up.
2. Insert the CF3 module—Hold the module above the socket and line up the triangles on the module and socket, then place the module in the socket. The module should drop into place when you have it aligned properly. Do not insert at an angle as this may damage the socket pins.

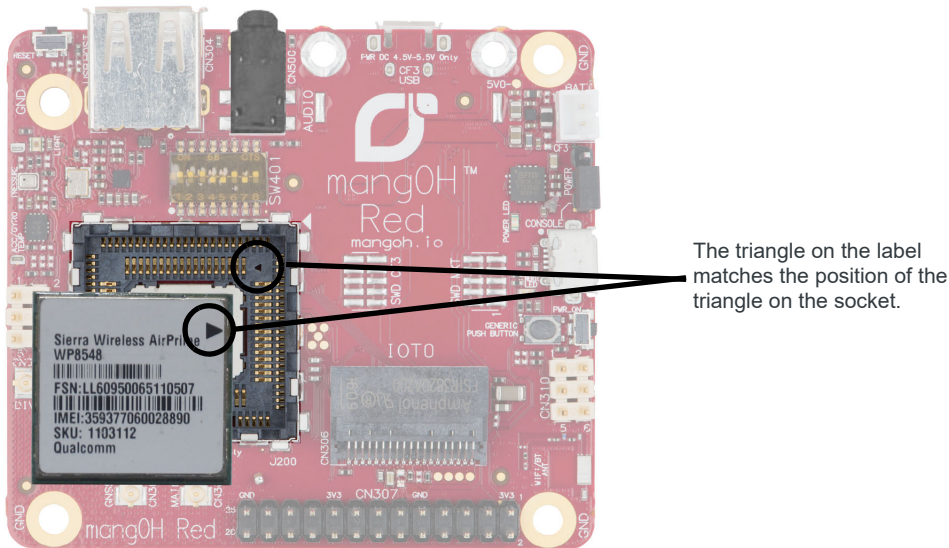

Figure 3-1: mangOH Red—Module Insertion

3. Hold the module cover over the module and line up the circle on the cover with the triangle on the label, then press down carefully on the cover (on the edges) until you hear the cover click into place. Make sure all sides of the cover have clicked into place.

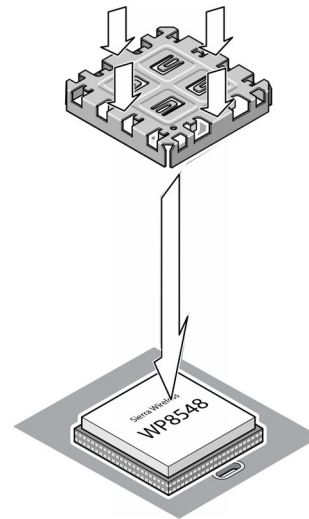
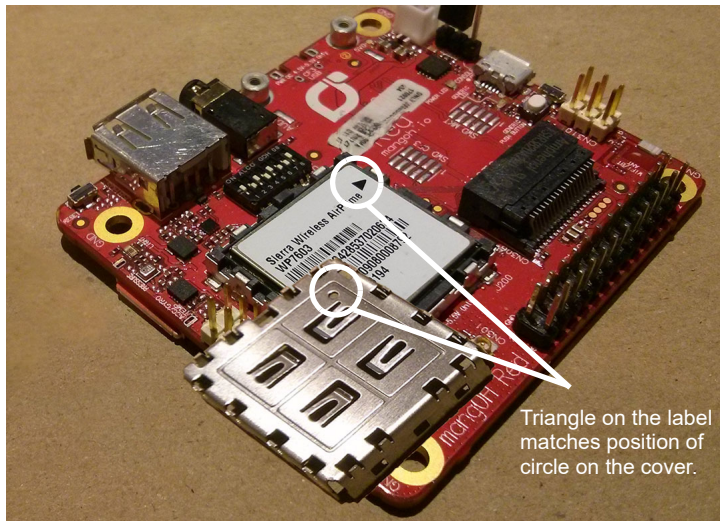

Figure 3-2: mangOH Red—Module Cover Attachment

To remove a CF3 module from the mangOH Red:

1. Remove the module cover using the module cover removal tool—Starting at one corner, insert the tool in the pair of holes and carefully pry the cover away from the module.
2. Repeat at the other locations (pairs of pry holes are on each side).

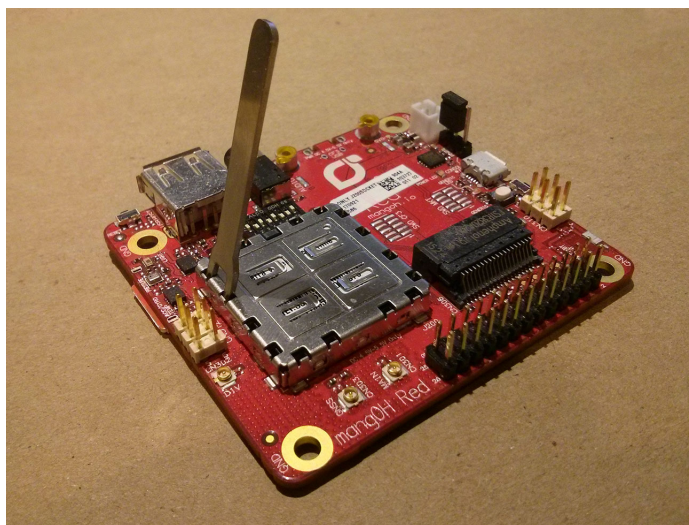

Figure 3-3: mangOH Red—Module Removal

3. Lift the cover off the module.
4. Carefully lift the module straight up out of the socket.

3.5 Power Supply Sources

The mangOH Red is powered via either of the board's micro-USB connectors or an optional backup battery. The micro-USB connectors can connect to a computer's USB port or, if greater power is required, to an AC adapter.

Table 3-1: mangOH Red Power Supplies

Supply		Details
Primary	CN305—Console USB connector	Provides a serial connection to the mangOH Red.
	CN801—CF3 USB connector	Provides access to CF3 interfaces (ECM port, AT port, etc.)
Backup	CN802—Battery	An optional Li-ion or Li-polymer (3.7 V nominal) rechargeable battery can be installed to power the board if the primary power supply fails.

3.5.1 Select USB Power Supply

Power is supplied to the mangOH red via USB connection (host computer or AC adapter) or an external battery backup.

The mangOH Red has two USB connectors:

- CF3 USB—Used for SSH connections, AT commands, and firmware downloads.
- CONSOLE_USB—Serial connection used to access the module's console for diagnostic purposes.

Note: If you want to power the mangOH Red with an AC adapter instead of a computer's USB connector, choose the appropriate micro-USB connector:

- *Console—This leaves the CF3 USB connector available for SSH connections, AT commands, and firmware downloads.*
 - *CF3 USB—This leaves the Console USB connector available for a serial connection to access the module's console for diagnostic purposes.*
-

To select the USB power supply:

1. Place the mangOH Red face-up and locate the power select (PWR SEL) jumper pins (CN804).

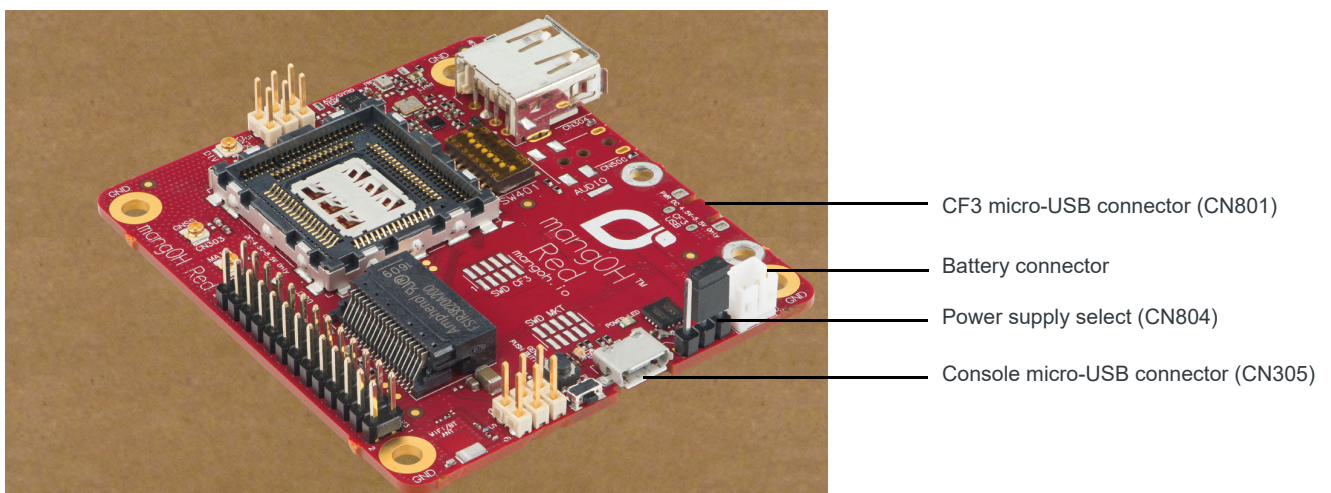

Figure 3-4: Power Supply Connectors/Selector

2. Select the preferred power source:
 - CF3 USB connector—Place a jumper across the two pins closest to USB connector CN801.
 - Console USB connector—Place a jumper across the two pins closest to USB connector CN305.

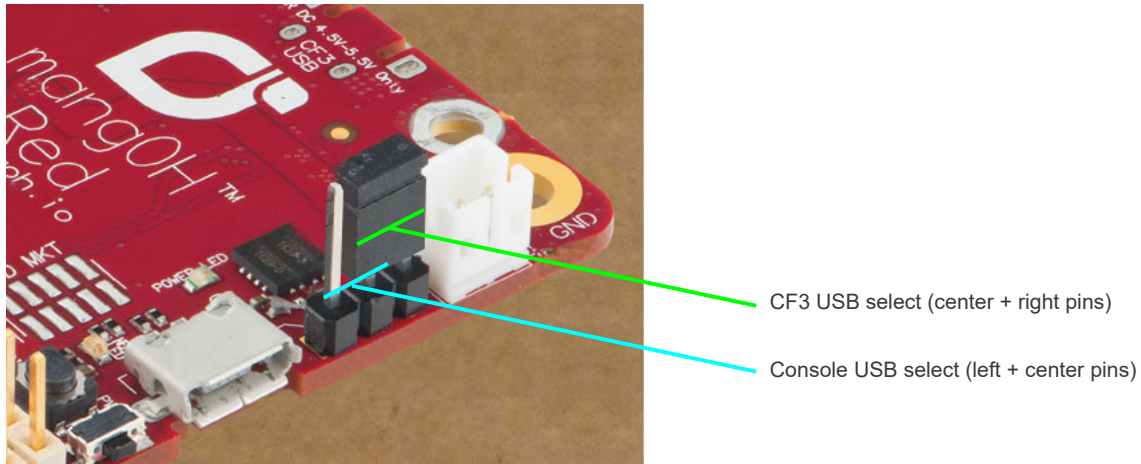

Figure 3-5: USB Power Supply Selection

3.5.2 Connect Battery Backup

Optionally, you can connect a rechargeable Li-Ion/Li-Polymer battery to the mangOH Red to provide uninterrupted power in the event that the primary power supply fails.

If SW401 pin 5 is ON, the mangOH Red recharges the battery and then provides a trickle charge to maintain the battery's full charge.

To connect a rechargeable Li-Ion/Li-Polymer battery to the mangOH Red:

1. Connect the battery to CN802.

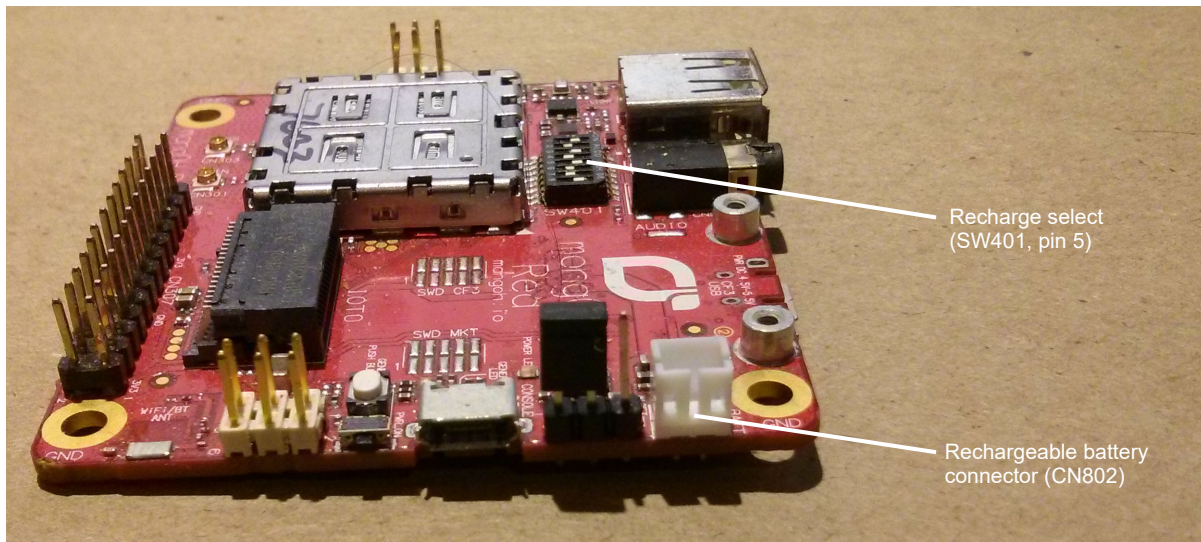

Figure 3-6: Battery Backup Connector

- If you want the battery to recharge while connected to the board, set switch SW401 pin 5 to ON.

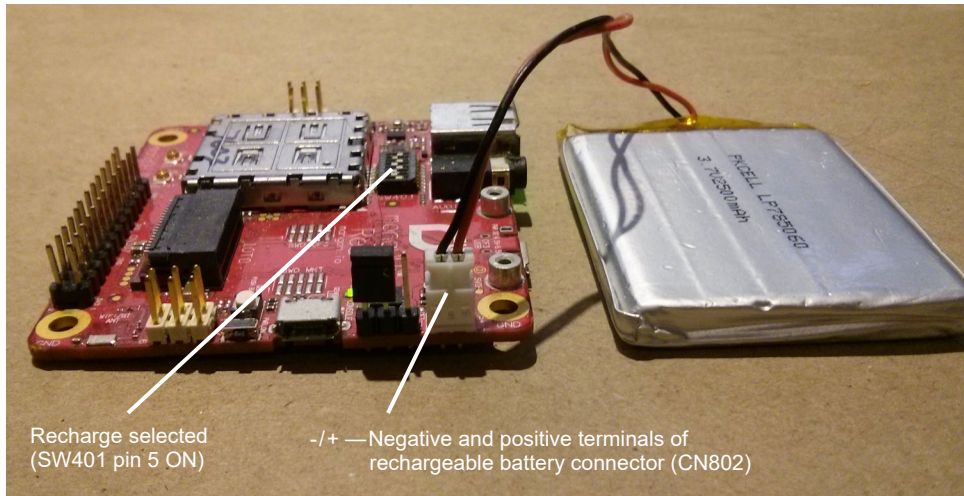

Figure 3-7: mangOH Red With Rechargeable Battery Connected

Caution: If a rechargeable battery is not connected to the board, make sure to set switch SW401 pin 5 to OFF.

Caution: The board is designed to use a rechargeable Li-Ion or Li-polymer battery. Regular (non-rechargeable) batteries are NOT recommended. However, if a regular battery is used, switch SW401 pin 5 MUST be set to OFF, otherwise the battery and possibly the board will be damaged.

3.6 Connect Antenna(s)

The mangOH Red includes three antenna connectors for the CF3 module.

Table 3-2: Antenna Connectors

Type	Connector ^a	Details
Main	CN301	Required to establish a mobile network data connection
Diversity	CN302	Used only if CF3 module supports diversity.
GNSS	CN303	<ul style="list-style-type: none"> Required to enable access to GNSS functionality Active 3.3 V bias voltage

a. U.FL connectors

Note: The mangOH Red includes an integrated antenna for the Wi-Fi/BT chipset.

To connect an antenna to the Main, Diversity or GNSS antenna connector:

- Place the mangOH Red face-up.

2. Attach the main antenna, the GNSS antenna, and (for WP76xx modules) the diversity antenna.

Note: Press the antenna connector firmly to get a secure connection. Also, the female connectors (on the antenna) are rated for a limited number of reconnects before the connector wears out, so should be left connected if possible. Use a U.FL extraction tool to put less strain on the connector during removal.)

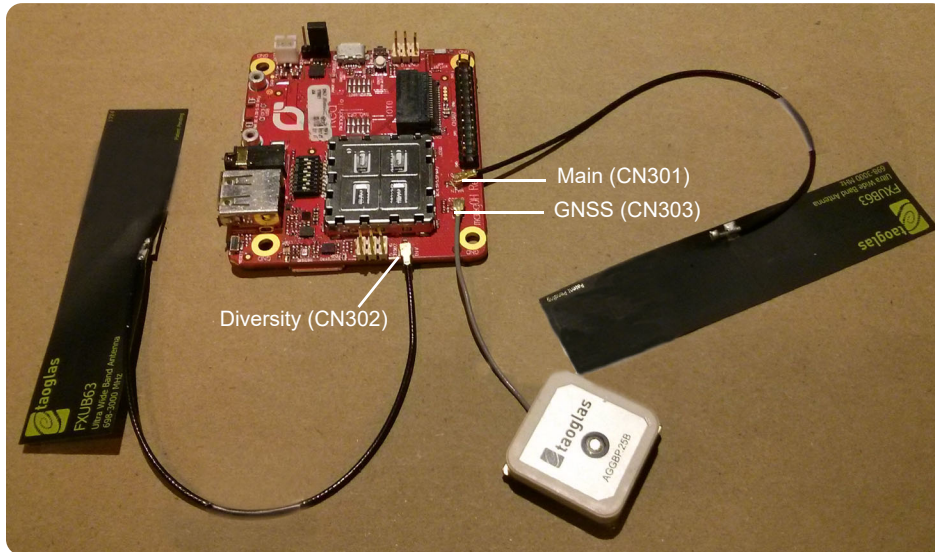

Figure 3-8: Antenna Connector Locations

Tip: If you have trouble connecting an antenna, make sure it is positioned directly on the connector and push straight down. The antenna will not connect at an angle.

3.7 SIM, SD, and IoT Expansion Cards

3.7.1 Inserting a micro-SIM Card

To establish a mobile network connection with a CF3 module, you must install a micro-SIM in the connector on the bottom side of the mangOH Red. Use either of the following:

- SIM card with activated account (e.g. the Sierra Wireless or AT&T SIM provided with the kit, or another carrier's activated card), or
- Test SIM card for use with a call box (for example, an Agilent 8960 or Rohde & Schwarz CMU200)

To install a SIM card:

1. Place the Dev Kit face-down (as shown).

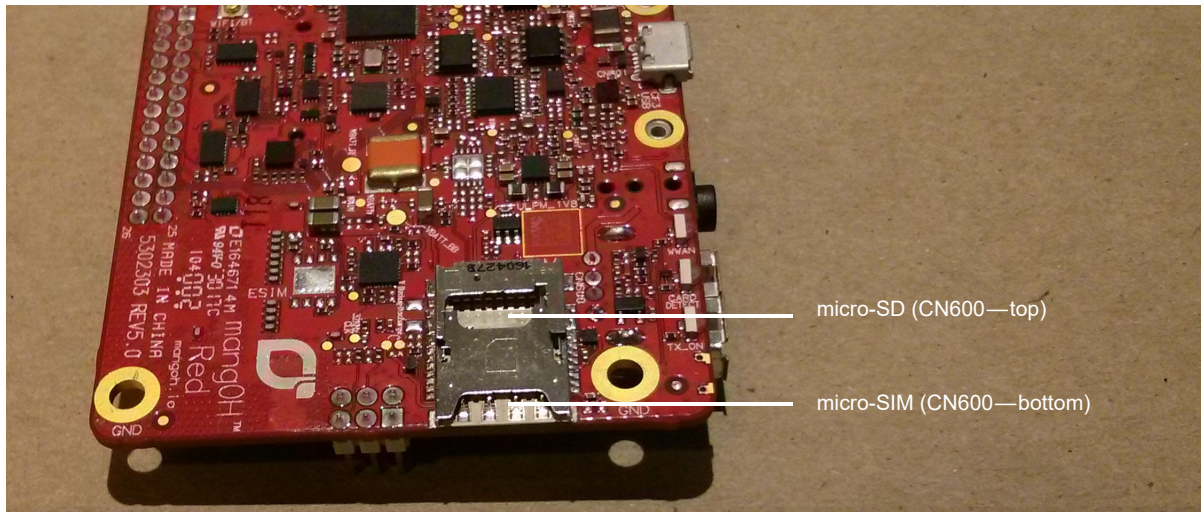

Figure 3-9: SIM Connector and micro-SD Locations

2. Insert the SIM card with contacts face-down into the desired slot—note the location of the notched corner of the card in [Figure 3-10](#).

Important: CN600 is a dual-connector—the lower slot is for the micro-SIM, and the upper slot is for a microSD card.

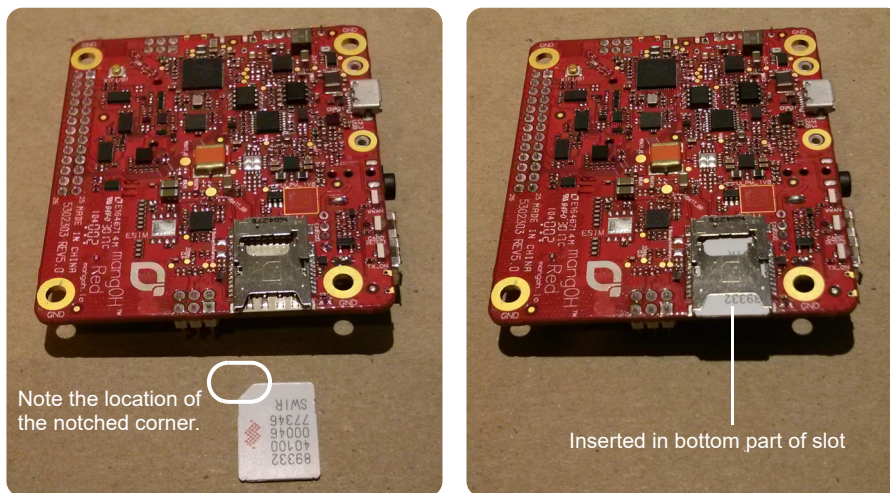

Figure 3-10: SIM Insertion

3.8 Inserting a microSD Card

To install a microSD card:

1. Place the Dev Kit face-down (as shown).

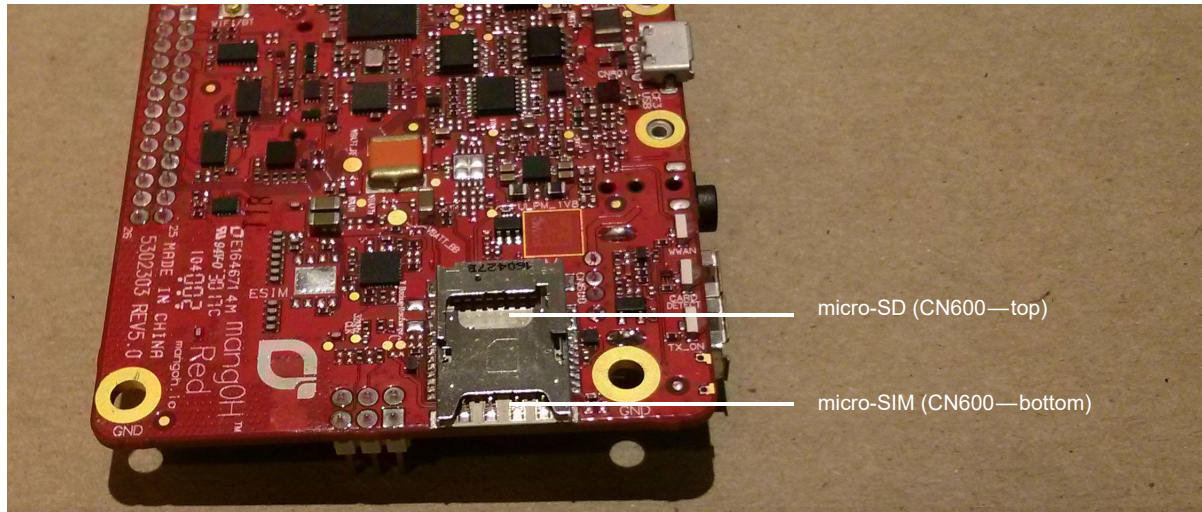

Figure 3-11: SIM Connector and microSD Locations

2. Insert the microSD card with contacts face-down into the top slot of CN600.

Important: CN600 is a dual-connector—the upper slot is for the microSD card, and the lower slot is for a micro-SIM.

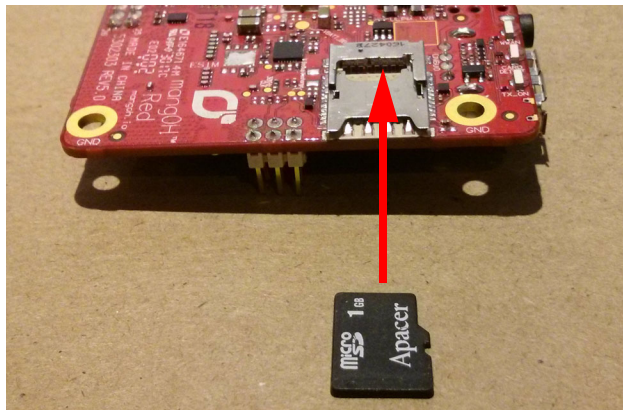

Figure 3-12: microSD—Inserting

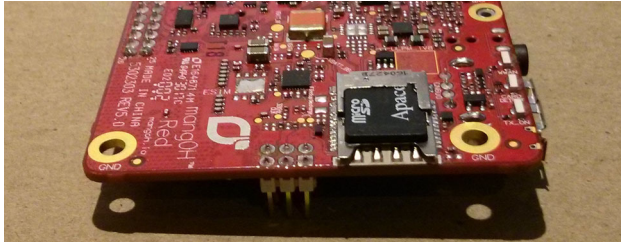

Figure 3-13: microSD—Inserted

3.8.1 Inserting/Removing an IoT Expansion Card

The mangOH Red includes one IoT Expansion Card slot.

Caution: Handle IoT Expansion Cards carefully to make sure components are not accidentally damaged. Hold them by their edges to avoid possible ESD damage.

To install an IoT Expansion Card:

1. Remove power from the mangOH Red (disconnect the micro-USB cable from the computer or AC adapter).

Note: You must remove the power because IoT Expansion Cards are not hot-swappable—the card will be recognized when power is reapplied.

2. Check the expansion card to make sure you know which side is the top. (Expansion cards must not be inserted upside-down.)
3. Slide the expansion card straight into the IoT Connector (CN306).
4. Use two M2 screws (included) to secure the expansion card to the standoffs.

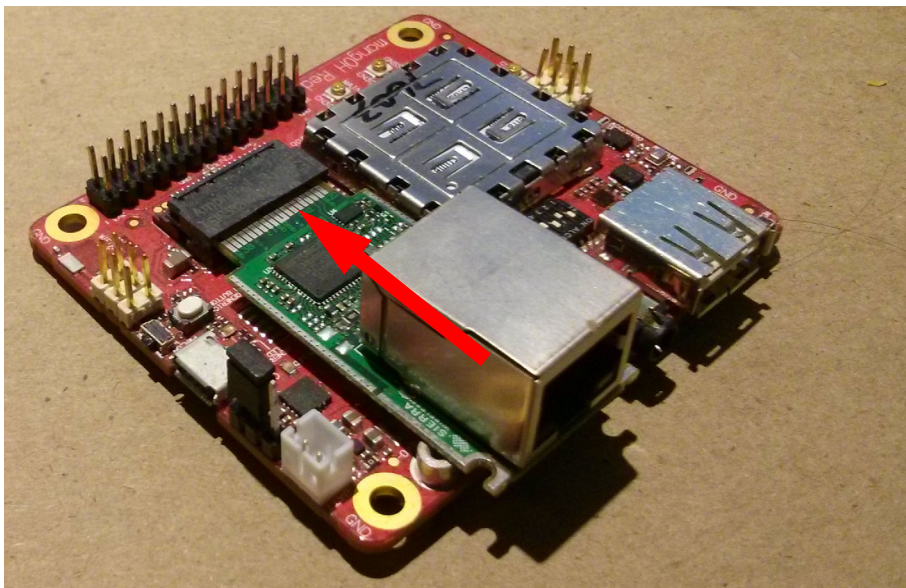

Figure 3-14: IoT Expansion Card Insertion

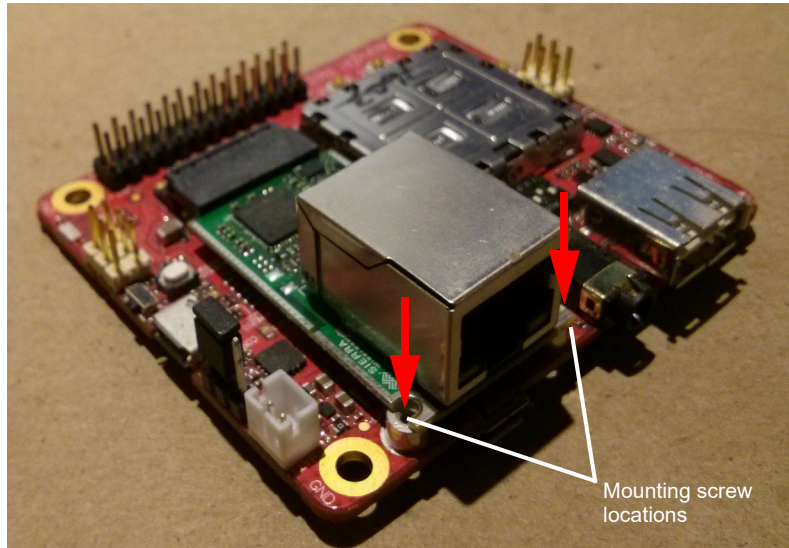

Figure 3-15: IoT Expansion Card Inserted

To remove an IoT Expansion Card:

1. Remove the two screws.
2. Pull the expansion card straight out, using safe ESD-handling practices (such as wearing proper ESD straps).

For detailed IoT Expansion Card slot interface information, refer to the mangOH Red Developer's Guide. For detailed information about expansion cards, refer to the IoT Expansion Card Specification.

3.9 Peripheral Connectors

3.9.1 Raspberry Pi Connector

CN307 is a 26-pin connector that provides access to primary Raspberry Pi Rev B pin functions.

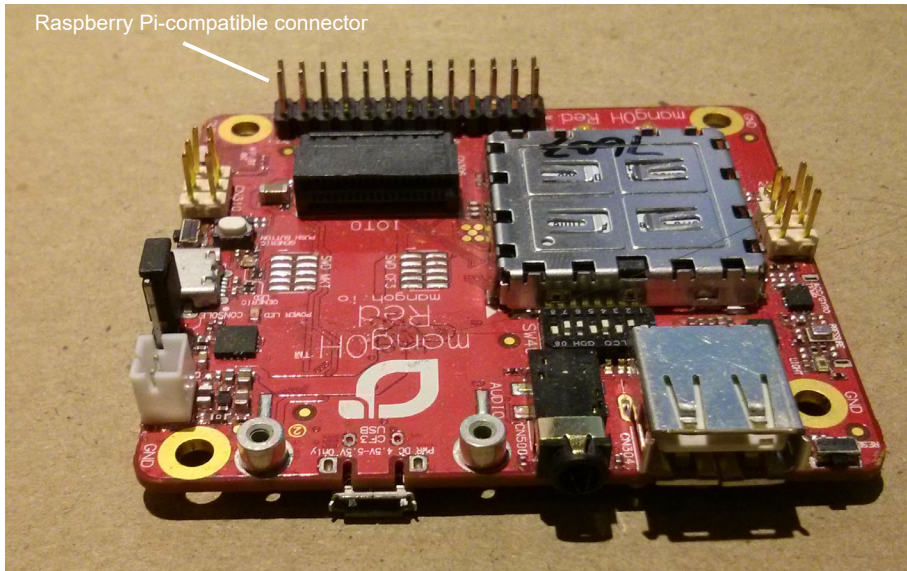

Figure 3-16: Raspberry Pi Connector

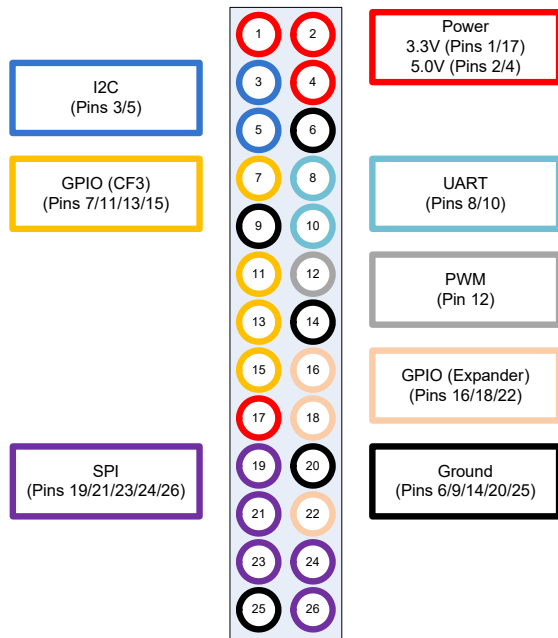

Figure 3-17: Raspberry Pi Connector Signal Groups

3.9.2 Audio Connection

The mangOH Red includes a 3.5 mm audio jack (CN500) for use with audio-enabled CF3 modules. If supported by the CF3 module, the jack can be used to make a voice call.

By default, the audio jack is connected to the onboard mangOH codec, and is configured for use with a CTIA/AHJ-compatible headset. For details, see [Table 3-4](#) on page 30.

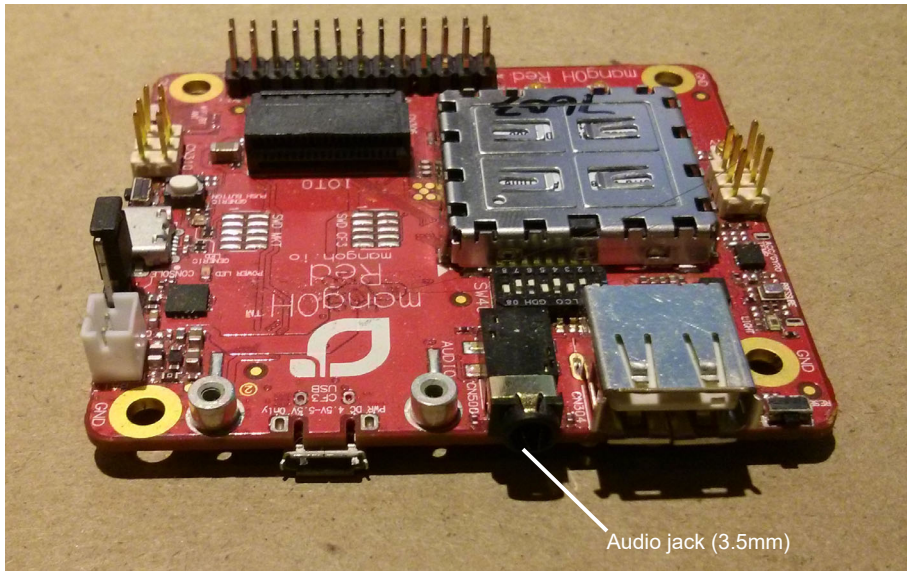

Figure 3-18: Audio Output Jack

3.9.3 USB Host Connection

The mangOH Red includes a USB 2.0 Host port (CN304) for attaching a peripheral device, memory stick, etc.

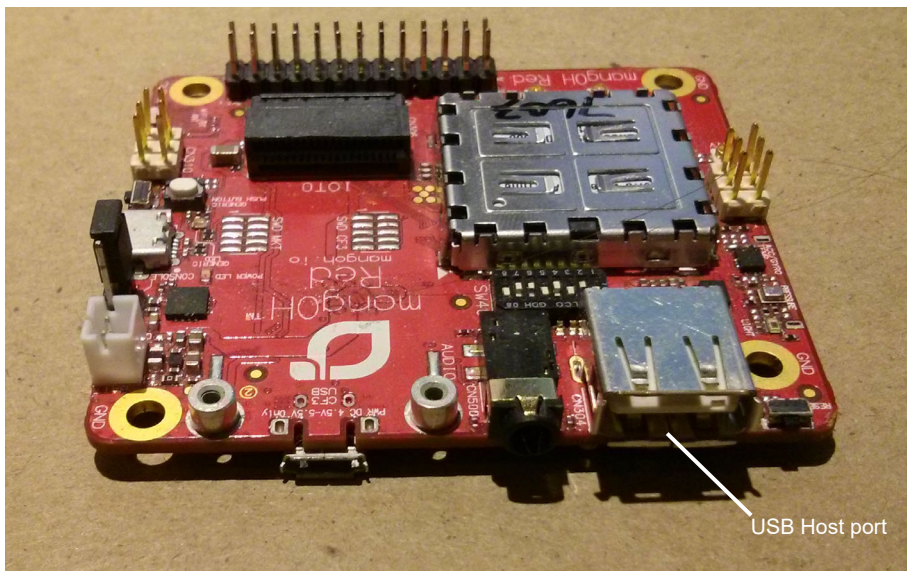

Figure 3-19: USB Host Port

3.10 Control Connections

3.10.1 Console USB Connector

The mangOH Red includes a micro-USB 2.0 connector (CN305) for console access.

By default, this port is enabled and configured to connect to the CF3 module's two-wire UART interface (UART2).

The connection can be used to access the CF3 module's Linux console (on Smart CF3 modules), the Wi-Fi/BT chipset's console, and to install firmware downloads on the CF3 module or Wi-Fi/BT chipset.

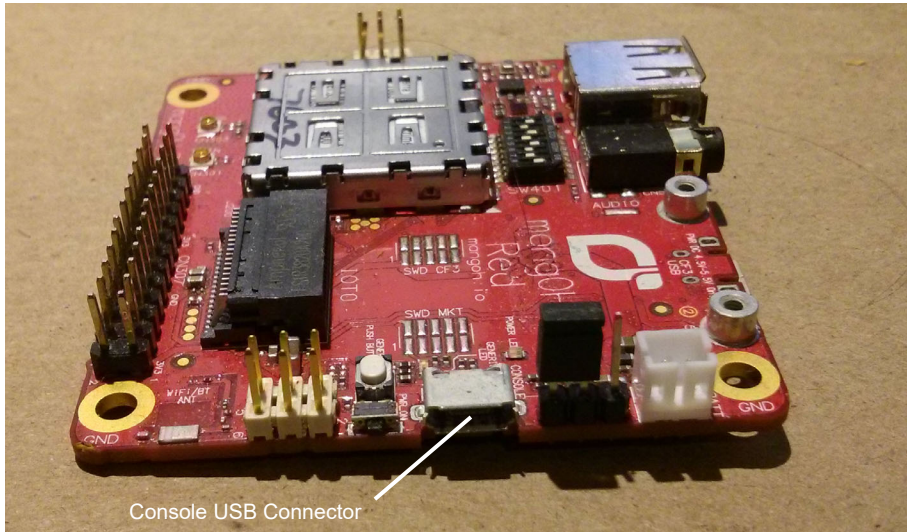

Figure 3-20: Console USB Output Connection

3.10.2 CF3 USB Connection

The mangOH Red includes a micro-USB 2.0 connector (CN801) for access to the CF3 module's interfaces (ECM, AT, etc.), and to install firmware downloads on the Wi-Fi/BT chipset.

By default, this port is enabled and configured to connect to the CF3 module's USB interface.

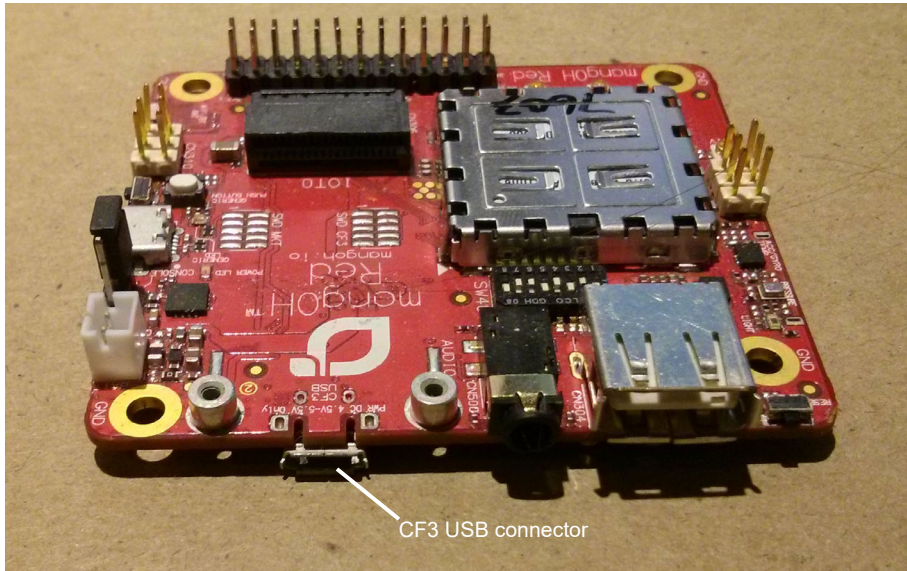

Figure 3-21: CF3 USB Connector

3.11 LED Indicators

The mangOH Red includes several LED indicators.

Table 3-3: mangOH Red LEDs

LED	Description
1—Power (VCC_3V3)	D803 - On when power is supplied by any power source (USB, battery)
2—IoT Expansion Card 0	D401 - On when an IoT Expansion Card is installed in slot IOT0.
3—CF3 RF Rx/Tx	D402 - On when the CF3 module is sending (Tx) or receiving (Rx) data
4—WLAN connected	D200 - On when the device is connected to a WLAN <i>Note: Off when low power is enabled.</i>
5—Generic	D410 - Connected to CF3 GPIO34 (via expander WP_GPIO_7_lvl), available for user-defined purposes

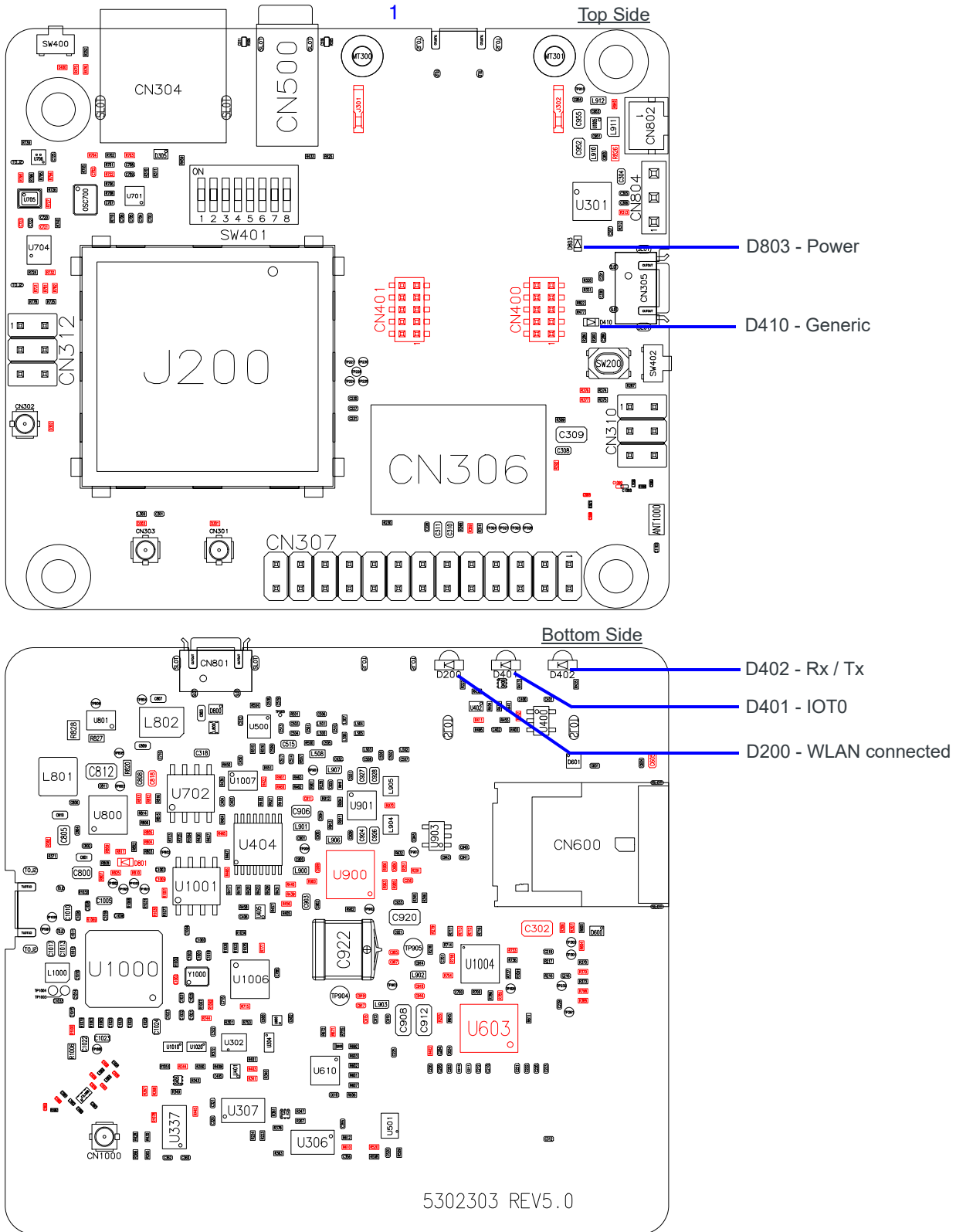

Figure 3-22: LED Indicators

3.12 Physical Switches

3.12.1 Reset Switches

The mangOH Red includes two reset switches:

- Board reset (SW400)—Press and hold for 5 seconds to reset the board.

Note: When the board is resetting, the reset signal is held LOW until the CF3 module is fully booted.

- ULPM/PWR_ON (SW402)—If SW401 pin 1 (PWR_ON) is:
 - Off—When power is connected to the board, press and release SW402 to power on the module. After the module powers on, SW402 has no effect.
 - On—When power is connected to the board, power is supplied automatically to the module. SW402 has no effect.

For details on resetting the mangOH Red or specific application blocks, see the mangOH Red Developer's Guide.

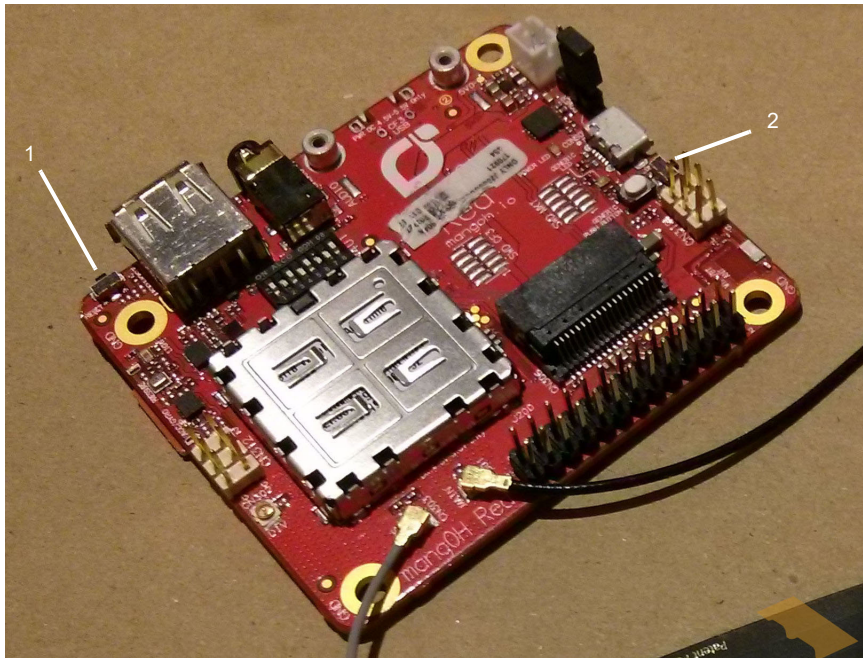

1—Board reset (SW400)
2—ULPM/PWR_ON (SW402)

Figure 3-23: Reset Switches

3.12.2 Buttons

The mangOH Red includes one generic button (SW200) for user-defined purposes.

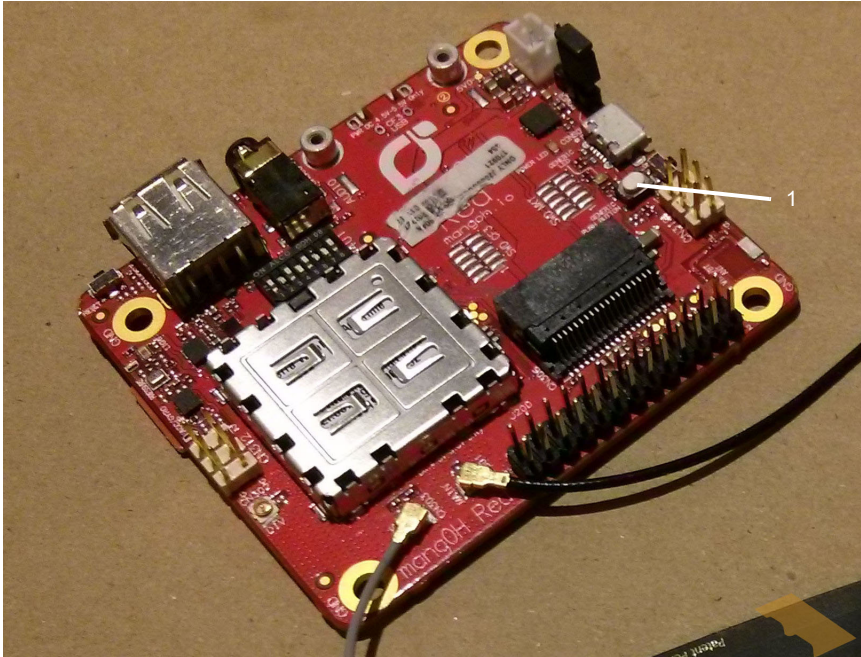

1—Generic button (SW200)

Figure 3-24: Buttons

3.13 mangOH Red Configuration

3.13.1 Default Configuration

The mangOH Red's default configuration is described in [Table 3-4](#).

Table 3-4: mangOH Red Default Configuration

Component / Switch	Default Configuration / Behavior	Notes
Antenna connectors (CN301, CN302, CN303)	<ul style="list-style-type: none"> U.FL connectors 3.3 V bias voltage for active antennas 	
Audio connector (CN500)	<ul style="list-style-type: none"> Connected to onboard mangOH codec CTIA/AHJ-compatible headset 	
Console USB connector (CN305)	<ul style="list-style-type: none"> Enabled Connected to CF3 module's UART2 	
CF3 USB connector (CN801)	<ul style="list-style-type: none"> Enabled Connected to CF3 module's USB interface 	
LEDs	All LEDs are enabled and will exhibit their default behaviors	
System reset signal (RESET_IN_N)	Held LOW until CF3 module is fully booted	Peripherals on the mangOH Red are not activated until the module is fully booted.

Table 3-4: mangOH Red Default Configuration

Component / Switch	Default Configuration / Behavior	Notes
SD connector (CN600)	Connected to CF3 module	Board can be configured using a software command to connect the module's SDIO signals to IOT1 instead of the SD connector.
Peripheral interfaces (UART, SPI, I2C, etc.)	See the mangOH Red Developer's Guide for details.	
Module Signals Control (SW401)	<ul style="list-style-type: none"> • PWR_ON (Dip 1)=ON • WIFI_UART1_TX (Dip 2)=OFF • VCC_3V7_ULPM (Dip 3)=OFF • HL_MODE (Dip 4)=OFF • BATT_TS+ (Dip 5)=OFF • CONS_DIR (Dip 6)=OFF • TP1_BOOT (Dip 7)=OFF • LowPower_RESET (Dip 8)=ON 	Board is shipped with pins 1 and 8 ON. Pins 3 and 5 must also be switched to ON, as noted in Initial Setup on page 10

3.13.2 Switch and Jumper Configuration Options

The mangOH Red uses several switches and jumpers to configure the board and CF3 module's operation, as detailed below in [Table 3-5](#) through [Table 3-8](#).

To locate these switches and jumpers, see [Figure 3-25](#) on page 34 and [Figure 3-26](#) on page 35.

Table 3-5: CN804—Board Power Select^a

Power supply selection	Jump 1–2	Jump 2–3
Console micro-USB connector (CN305)	Yes	
CF3 USB micro-USB connector (CN801)		Yes

a. Required: Select one option only (Jump 1–2 or Jump 2–3). For details, see [Select USB Power Supply](#) on page 15.

3.14 Real-time I/O

The mangOH Red includes a connector (CN310) that provides access to the board's Wi-Fi/BT chipset for real-time input/output with sensors and other devices.

Table 3-6: CN310—Real Time I/O

Pin	Signal	Purpose
1	WIFI_I2C0_DATA	I2C bus for sensors and other devices
2	GPIO_1_EXP	User-defined GPIO
3	WIFI_I2C0_CLK	I2C bus for sensors and other devices

Table 3-6: CN310—Real Time I/O (Continued)

Pin	Signal	Purpose
4	ADC1_WIFI	Analog input
5	GPIO_0_EXP	User-defined GPIO
6	ADC2_WIFI	Analog input

3.15 Low-power I/O

The mangOH Red includes a connector that provides GPIOs and ADCs that can continue to be accessed when the CF3 module is in low power mode, and can provide low voltage power to the external sensors/devices connected to those pins.

Table 3-7: CN312—Low Power I/O

Pin	Signal	Purpose
1	WP_GPIO_4_wakeable	May be used to wake CF3 module from sleep mode (if supported by module)
2	VCC_1V8_ULPM	Low power voltage available for external sensors/devices (since main power is not available during low power mode)
3	WP_GPIO_5_wakeable	May be used to wake CF3 module from sleep mode (if supported by module)
4	ADC1	
5	ADC2	
6	CARD2_DETECT	Wakeup pin for HL77XX modules

3.16 Module Signals Control

The mangOH Red uses a multi-function switch (SW401) to control specific signals.

Table 3-8: SW401—Module Signals Control

Signal	Dip	On/Off	State
PWR_ON	1	On (Default)	Enable CF3 module's POWER_ON signal
		Off	Disable POWER_ON signal
WIFI_UART1_TX	2	On	Enable CF3 module's firmware download (recovery) mode. <i>Note: Similar functionality to TP1_BOOT</i>
		Off (Default)	Normal operation
VCC_3V7_ULPM	3	On (Default)	While in ULPM, CF3 module and accessories receive power.
		Off	While in ULPM, only the CF3 module and accessories receive power.
HL_MODE	4	On	When combined with LowPower_RESET, indicates that board is in HL mode.
		Off (Default)	When combined with LowPower_RESET, indicates that board is in WP mode.
BATT_TS+	5	On	Enable backup battery charging.
		Off (Default)	Disable backup battery charging.
CONS_DIR	6	On	Console USB connector accesses the Wi-Fi/Bluetooth module's console. <i>Note: To download firmware to the Wi-Fi module, set CONS_DIR OFF and WIFI_UART1_TX ON.</i>
		Off (Default)	Console USB connector access the CF3 module's console.
TP1_BOOT	7	On	Enable CF3 module's TP1 (boot) signal functionality. Pull the signal low to enter download mode for firmware updates.
		Off (Default)	CF3 module functions normally.
LowPower_RESET	8	On	When combined with HL_MODE, indicates that board is in WP mode.
		Off (Default)	When combined with HL_MODE, indicates that board is in HL mode.

- 1—Pluggable IoT connector (CN306 (IOT0))
- 2—Power supply select (CN804)
- 3—Battery connector (CN802)
- 4—Signals control (SW401)
- 5—Main antenna (CN301)
- 6—GNSS antenna (CN303)
- 7—Diversity antenna (CN302)
- 8—Wi-Fi/Bluetooth antenna (ANT1000)
- 9—USB Host (CN304)
- 10—Audio (CN500)
- 11—Console micro-USB connector (CN305)
- 12—Raspberry PI RevB-compatible header (CN307)
- 13—Generic button (SW200)
- 14—PWR_ON switch (SW402)
- 15—Reset switch (SW400)
- 16—CF3 module socket (J200)
- 17—Real Time I/O (CN310)
- 18—Low Power I/O (CN312)

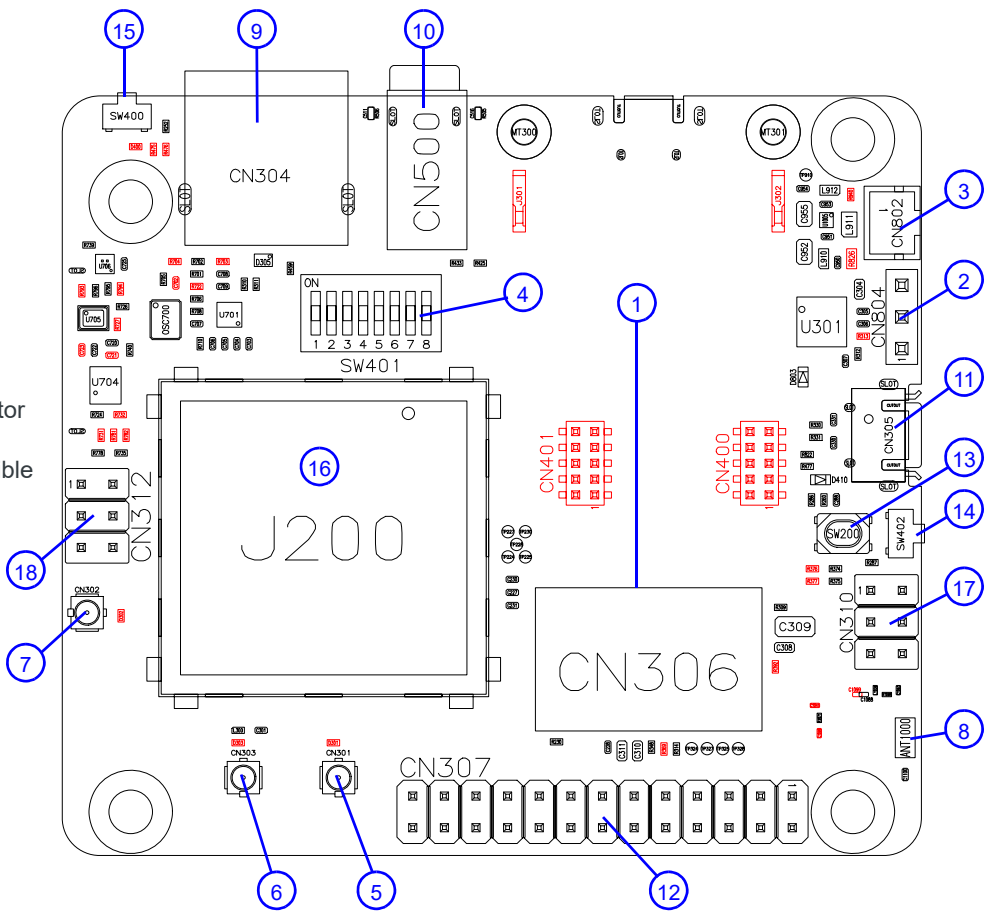

Figure 3-25: mangOH Red Assembly— Top Side Switches/Connectors

Note: For reference only. For latest schematic, visit mangoh.io/mangoh-red-resources-hardware.

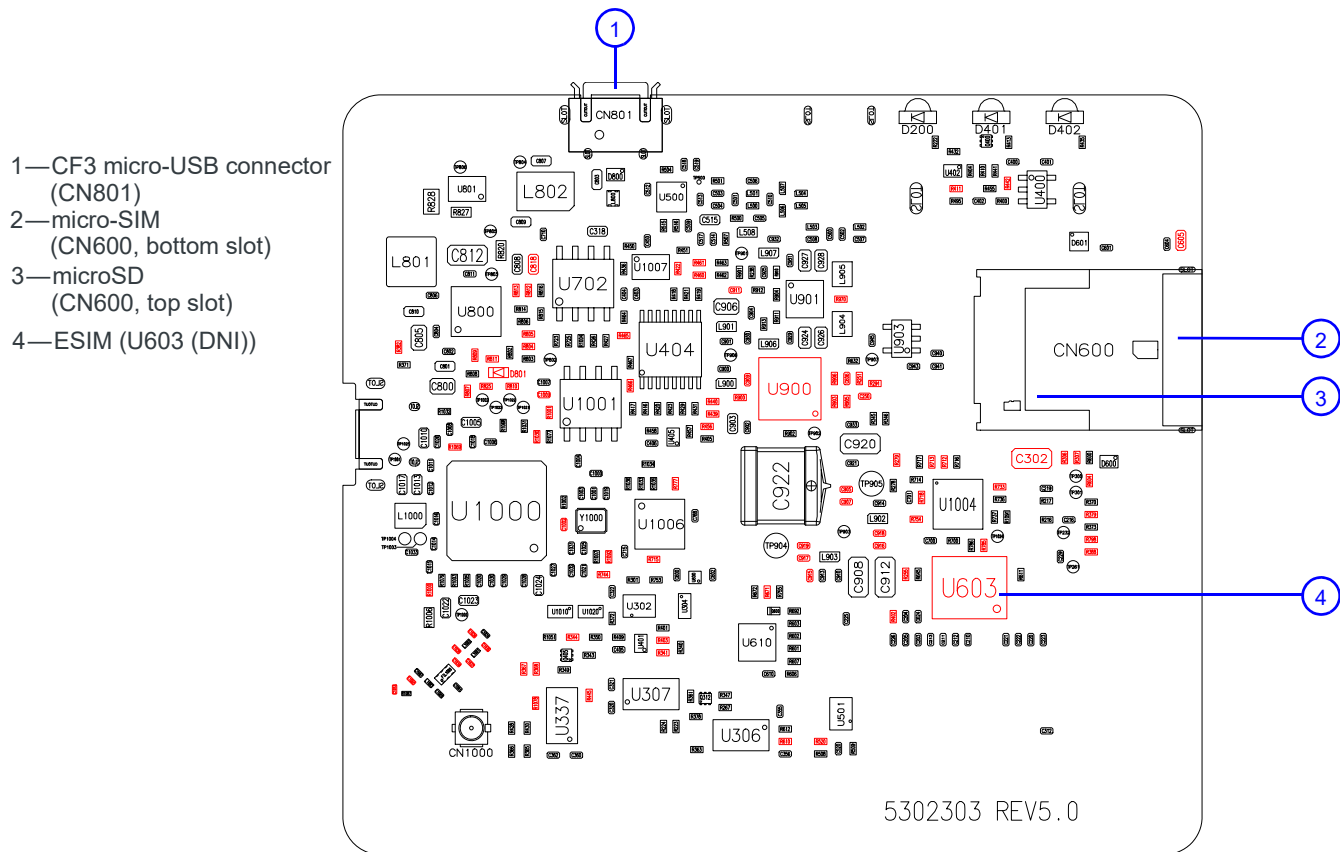

Figure 3-26: mangOH Red Assembly - Bottom Side Connectors

Note: For reference only. For latest schematic, visit mangoh.io/mangoh-red-resources-hardware.

4: Software Setup

This chapter describes software resources that you will need on your computer to access the mangOH Red and develop applications for its CF3 module.

Sample applications and instructional materials are available from the sites mentioned in this chapter. For detailed information on developing for the mangOH Red, see the mangOH Red Developer's Guide and related documents (available from mangoh.io/mangoh-red-resources).

4.17 Install / Update Windows Driver

If you are using a Windows computer, you must install the Legato driver for the CF3 module that you install in your mangOH Red.

1. Go to mangoh.io/mangoh-red-resources-getting-started.
2. In the Getting Started with mangOH section, click Drivers for mangOH-compatible CF3 Modules (under the Windows icon) to download the driver installation file.

Note: The link will take you to source.sierrawireless.com. If you already have a Source account, log in. Otherwise, register for a Source account, which is required to download files.

3. Run the downloaded file (GenericDriverSetup.exe) and follow the prompts to install the drivers.
4. When the mangOH Red is connected via USB to the computer, display the Device Manager (Control Panel > System > Device Manager).

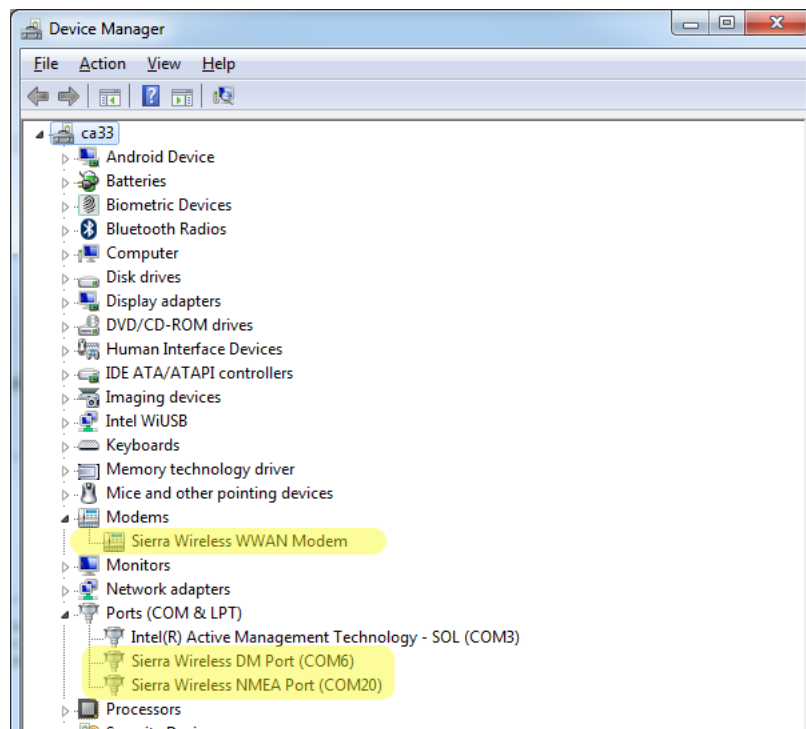

Figure 4-1: Windows Device Manager

If the driver installed correctly, you will see the following items listed: %%these will vary by wp type I think?

- Modems > Sierra Wireless WWAN Modem (This is the module in socket J200.)
- Ports [COM & LPT] > Sierra Wireless AT Command Port
- Ports [COM & LPT] > Sierra Wireless DM Port
- Ports [COM & LPT] > Sierra Wireless NMEA Port (This is the port that you will use to communicate with the module from your terminal emulator.)

4.18 Install a Terminal Emulator

To communicate with the mangOH Red, you need a terminal emulator program such as Tera Term or HyperTerminal®.

When you have an emulator installed, use it to establish a console connection to the mangOH Red:

- Port—Serial modem COM port (for Sierra Wireless devices, this is the Sierra Wireless NMEA Port)%%fix
- Baud rate—115200

4.19 Download Firmware Updates

Firmware updates are available for download from source.sierrawireless.com.

To update your CF3 module's firmware to the latest available version:

1. Go to your CF3 module's device page at source.sierrawireless.com. (Select AirPrime > WP Series > (your module type).)
2. If you already have a Source account, log in. Otherwise, register for a Source account, which is required to download files.
3. In the Software Download section, click Firmware.
4. In the Firmware Update Instructions table's Instructions with one-click tool (Windows) row, click the Generic firmware link to download the file. (If there is more than one Generic, click the Generic GCF link.)
5. Launch the downloaded executable file (e.g. WP76xx_Release8...exe). A progress window appears. This will take several minutes to run.
6. Wait (1–2 minutes) while the module reboots with the new firmware.
7. Ping the mangOH Red — when replies appear, the module has rebooted and you can continue.
\$ ping 192.168.2.2 (Press CTRL-C to cancel)

To verify that the firmware updated:

1. In the mangOH VM, open a terminal window and connect to the mangOH Red:
\$ ssh root@192.168.2.2
2. Display the firmware version now loaded on the CF3 module, and compare it to the version before the firmware update was installed — the version should be the same or a higher value:
cm info
3. Disconnect from the mangOH Red:
exit

4.20 Write Your First Program

For instructions on building applications (including writing a 'Hello World' program to test your mangOH Red), and to download sample Legato applications, visit mangoh.io/mangoh-red-resources.

A: Console Access

If you have two USB ports on your dev machine, you can use one of them to display the mangOH Red's diagnostic messages when the device boots, when certain commands are run, etc.

To set up a window to display diagnostic messages:

1. Use a micro-USB cable to connect the mangOH Red's CONSOLE USB port to a USB port on the dev machine.

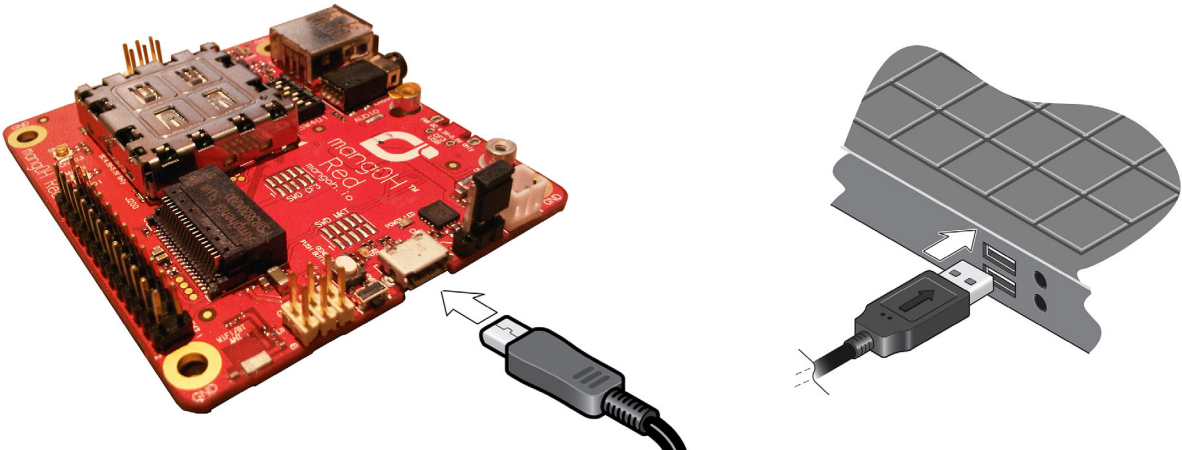

Note: one console connection can be opened at any time since it locks the USB serial port.

Example

If you open the console terminal window before you connect power to the mangOH Red, you will see the messages that are generated during the module boot process: