





CERAMIC RF CHIP INDUCTORS

PE-0402CL SERIES



-  Monolithic inorganic material construction Low
-  DC resistance, high Q Values at high frequency
-  High Self Resonant Frequency
-  Industry Standard 0402 (1005) Surface Mount Land Pattern
-  Operational temperature -55°C to +125°C

Electrical Specifications @ 25°C

Part Number	Inductance (nH)	Standard Tolerance	Q (Min.)	Test Frequency (MHz)	SRF (MHz MIN)	R _{dc} (Ω MAX)	I _{dc} (mA MAX)
PE-0402CL1N0STT	1.0	±0.3nH (S)	8	100	10000	0.1	400
PE-0402CL1N2STT	1.2	±0.3nH (S)	8	100	10000	0.1	400
PE-0402CL1N5STT	1.5	±0.3nH (S)	8	100	6000	0.1	300
PE-0402CL1N8STT	1.8	±0.3nH (S)	8	100	6000	0.1	300
PE-0402CL2N0STT	2.0	±0.3nH (S)	8	100	6000	0.2	300
PE-0402CL2N2STT	2.2	±0.3nH (S)	8	100	6000	0.2	300
PE-0402CL2N7STT	2.7	±0.3nH (S)	8	100	6000	0.2	300
PE-0402CL3N3STT	3.3	±0.3nH (S)	8	100	6000	0.2	300
PE-0402CL3N6STT	3.6	±0.3nH (S)	8	100	4000	0.2	300
PE-0402CL3N9STT	3.9	±0.3nH (S)	8	100	4000	0.2	300
PE-0402CL4N7STT	4.7	±0.3nH (S)	8	100	4000	0.2	300
PE-0402CL5N6STT	5.6	±0.3nH (S)	8	100	4000	0.3	300
PE-0402CL6N2STT	6.2	±0.3nH (S)	8	100	3900	0.3	300
PE-0402CL6N8JTT	6.8	±5% (J)	8	100	3900	0.3	300
PE-0402CL7N5JTT	7.5	±5% (J)	8	100	3700	0.4	300
PE-0402CL8N2JTT	8.2	±5% (J)	8	100	3600	0.4	300
PE-0402CL100JTT	10	±5% (J)	8	100	3200	0.4	300
PE-0402CL120JTT	12	±5% (J)	8	100	2700	0.5	300
PE-0402CL150JTT	15	±5% (J)	8	100	2300	0.5	300
PE-0402CL180JTT	18	±5% (J)	8	100	2100	0.5	300
PE-0402CL220JTT	22	±5% (J)	8	100	1900	0.6	300
PE-0402CL270JTT	27	±5% (J)	8	100	1600	0.7	300
PE-0402CL330JTT	33	±5% (J)	8	100	1300	0.8	200

CERAMIC RF CHIP INDUCTORS

PE-0402CL SERIES

Electrical Specifications @ 25°C

Part Number	Inductance (nH)	Standard Tolerance	Q (Min.)	Test Frequency (MHz)	SRF (MHz MIN)	RDC (Ω MAX)	IDC (mA MAX)
PE-0402CL470JTT	47	±5% (J)	8	100	1000	1.1	200
PE-0402CL560JTT	56	±5% (J)	8	100	750	1.2	200
PE-0402CL680JTT	68	±5% (J)	8	100	750	1.4	180
PE-0402CL820JTT	82	±5% (J)	8	100	750	2.4	150
PE-0402CL101JTT	100	±5% (J)	8	100	700	2.6	150
PE-0402CL121JTT	120	±5% (J)	8	100	600	2.8	150

Notes:

- Inductance measured using a HP4286A RF Impedance Analyzer. (Please note that inductance information is not stamped on part, because of the extremely small size).
- Q measured using a HP4291A RF Impedance Analyzer with a HP16193A Test Fixture.
- SRF measured using a HP8753C Network Analyzer.
- RDC measured using a Valhalla Scientific model 4100 ATC Digital Ohm meter.
- Based on a 15°C maximum temperature rise.

Mechanical

Schematic

0402CL Series

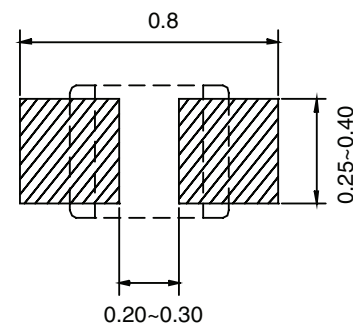
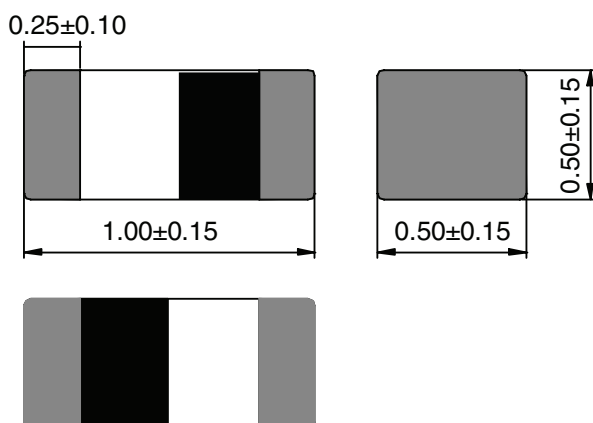

Dimensions: $\frac{\text{Inches}}{\text{mm}}$

Unless otherwise specified,
all tolerances are $\pm \frac{.010}{0,25}$

Characteristic Graphs

0402CL Series

Impedance v.s. Frequency Characteristics

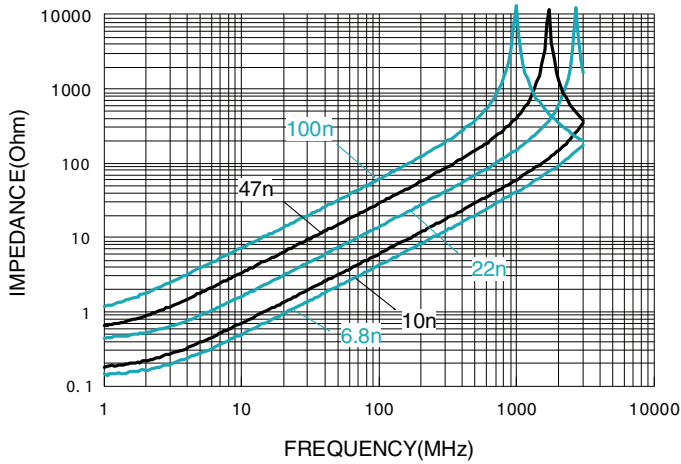

Inductance v.s. Frequency Characteristics

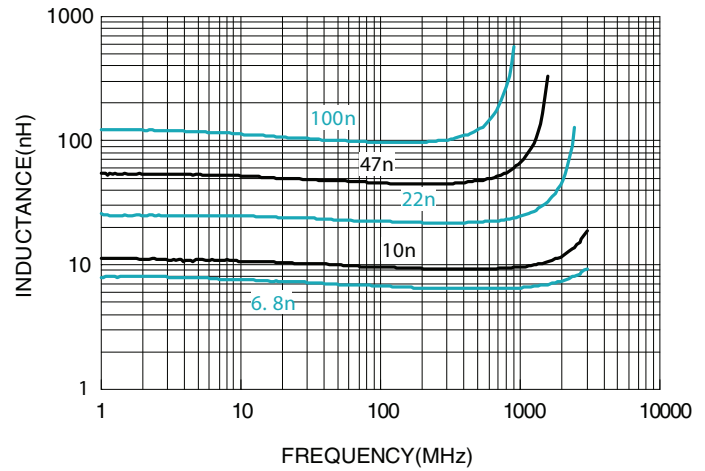

Q v.s. Frequency Characteristics

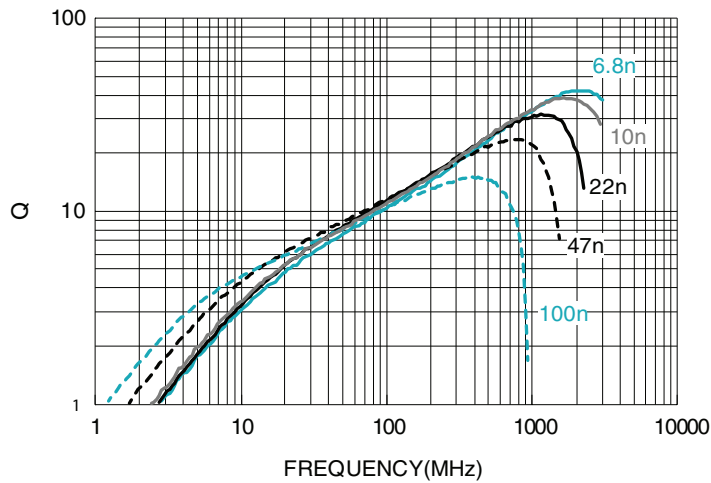

For More Information:

Americas - prodinfo@networkamericas@pulseelectronics.com | Europe - comms@pulseelectronics.com | Asia - prodinfo@networkapac@pulseelectronics.com

Performance warranty of products offered on this data sheet is limited to the parameters specified. Data is subject to change without notice. Other brand and product names mentioned herein may be trademarks or registered trademarks of their respective owners. © Copyright, 2020. Pulse Electronics, Inc. All rights reserved.