

# 2N6515, 2N6517, 2N6520

## High Voltage Transistors NPN and PNP

### Features

- Voltage and Current are Negative for PNP Transistors
- Pb-Free Package is Available\*

### MAXIMUM RATINGS

Rating	Symbol	2N6515	2N6517 2N6520	Unit
Collector – Emitter Voltage	$V_{CEO}$	250	350	Vdc
Collector – Base Voltage	$V_{CBO}$	250	350	Vdc
Emitter – Base Voltage 2N6515, 2N6516, 2N6517 2N6519, 2N6520	$V_{EBO}$	6.0 5.0		Vdc
Base Current	$I_B$	250		mAdc
Collector Current – Continuous	$I_C$	500		mAdc
Total Device Dissipation @ $T_A = 25^\circ\text{C}$ Derate above $25^\circ\text{C}$	$P_D$	625 5.0		mW mW/ $^\circ\text{C}$
Total Device Dissipation @ $T_C = 25^\circ\text{C}$ Derate above $25^\circ\text{C}$	$P_D$	1.5 12		Watts mW/ $^\circ\text{C}$
Operating and Storage Junction Temperature Range	$T_J, T_{stg}$	-55 to +150		$^\circ\text{C}$

Maximum ratings are those values beyond which device damage can occur. Maximum ratings applied to the device are individual stress limit values (not normal operating conditions) and are not valid simultaneously. If these limits are exceeded, device functional operation is not implied, damage may occur and reliability may be affected.

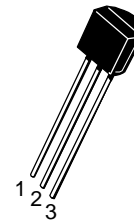
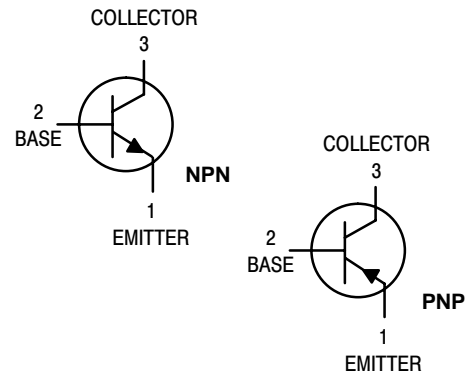
### THERMAL CHARACTERISTICS

Characteristic	Symbol	Max	Unit
Thermal Resistance, Junction-to-Ambient	$R_{\theta JA}$	200	$^\circ\text{C}/\text{W}$
Thermal Resistance, Junction-to-Case	$R_{\theta JC}$	83.3	$^\circ\text{C}/\text{W}$



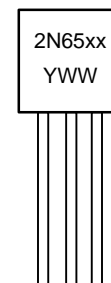
**ON Semiconductor®**

<http://onsemi.com>



TO-92  
CASE 29  
STYLE 1

### MARKING DIAGRAM



Y = Year  
WW = Work Week

### ORDERING INFORMATION

See detailed ordering and shipping information in the package dimensions section on page 3 of this data sheet.

\*For additional information on our Pb-Free strategy and soldering details, please download the ON Semiconductor Soldering and Mounting Techniques Reference Manual, SOLDERRM/D.

## 2N6515, 2N6517, 2N6520

### ELECTRICAL CHARACTERISTICS ( $T_A = 25^\circ\text{C}$ unless otherwise noted)

Characteristic	Symbol	Min	Max	Unit
<b>OFF CHARACTERISTICS</b>				
Collector–Emitter Breakdown Voltage (Note 1) ( $I_C = 1.0\text{ mAdc}$ , $I_B = 0$ )	$V_{(BR)CEO}$	250 350	– –	Vdc
		2N6515 2N6517, 2N6520		
Collector–Base Breakdown Voltage ( $I_C = 100\ \mu\text{Adc}$ , $I_E = 0$ )	$V_{(BR)CBO}$	250 350	– –	Vdc
		2N6515 2N6517, 2N6520		
Emitter–Base Breakdown Voltage ( $I_E = 10\ \mu\text{Adc}$ , $I_C = 0$ )	$V_{(BR)EBO}$	6.0 5.0	– –	Vdc
		2N6515, 2N6517 2N6520		
Collector Cutoff Current ( $V_{CB} = 150\text{ Vdc}$ , $I_E = 0$ ) ( $V_{CB} = 250\text{ Vdc}$ , $I_E = 0$ )	$I_{CBO}$	– –	50 50	nAdc
		2N6515 2N6517, 2N6520		
Emitter Cutoff Current ( $V_{EB} = 5.0\text{ Vdc}$ , $I_C = 0$ ) ( $V_{EB} = 4.0\text{ Vdc}$ , $I_C = 0$ )	$I_{EBO}$	– –	50 50	nAdc
		2N6515, 2N6517 2N6520		
<b>ON CHARACTERISTICS (Note 1)</b>				
DC Current Gain ( $I_C = 1.0\text{ mAdc}$ , $V_{CE} = 10\text{ Vdc}$ )	$h_{FE}$	35 20	– –	–
		2N6515 2N6517, 2N6520		
( $I_C = 10\text{ mAdc}$ , $V_{CE} = 10\text{ Vdc}$ )		50 30	– –	
		2N6515 2N6517, 2N6520		
( $I_C = 30\text{ mAdc}$ , $V_{CE} = 10\text{ Vdc}$ )		50 30	300 200	
		2N6515 2N6517, 2N6520		
( $I_C = 50\text{ mAdc}$ , $V_{CE} = 10\text{ Vdc}$ )		45 20	220 200	
		2N6515 2N6517, 2N6520		
( $I_C = 100\text{ mAdc}$ , $V_{CE} = 10\text{ Vdc}$ )		25 15	– –	
		2N6515 2N6517, 2N6520		
Collector–Emitter Saturation Voltage ( $I_C = 10\text{ mAdc}$ , $I_B = 1.0\text{ mAdc}$ ) ( $I_C = 20\text{ mAdc}$ , $I_B = 2.0\text{ mAdc}$ ) ( $I_C = 30\text{ mAdc}$ , $I_B = 3.0\text{ mAdc}$ ) ( $I_C = 50\text{ mAdc}$ , $I_B = 5.0\text{ mAdc}$ )	$V_{CE(sat)}$	– – – –	0.30 0.35 0.50 1.0	Vdc
Base–Emitter Saturation Voltage ( $I_C = 10\text{ mAdc}$ , $I_B = 1.0\text{ mAdc}$ ) ( $I_C = 20\text{ mAdc}$ , $I_B = 2.0\text{ mAdc}$ ) ( $I_C = 30\text{ mAdc}$ , $I_B = 3.0\text{ mAdc}$ )	$V_{BE(sat)}$	– – –	0.75 0.85 0.90	Vdc
Base–Emitter On Voltage ( $I_C = 100\text{ mAdc}$ , $V_{CE} = 10\text{ Vdc}$ )	$V_{BE(on)}$	–	2.0	Vdc

1. Pulse Test: Pulse Width  $\leq 300\ \mu\text{s}$ , Duty Cycle  $\leq 2.0\%$ .

## 2N6515, 2N6517, 2N6520

### SMALL-SIGNAL CHARACTERISTICS

Current-Gain – Bandwidth Product (Note 1) ( $I_C = 10 \text{ mA}$ , $V_{CE} = 20 \text{ Vdc}$ , $f = 20 \text{ MHz}$ )	$f_T$	40	200	MHz
Collector-Base Capacitance ( $V_{CB} = 20 \text{ Vdc}$ , $I_E = 0$ , $f = 1.0 \text{ MHz}$ )	$C_{cb}$	–	6.0	pF
Emitter-Base Capacitance ( $V_{EB} = 0.5 \text{ Vdc}$ , $I_C = 0$ , $f = 1.0 \text{ MHz}$ )	$C_{eb}$	–	80	pF
		–	100	
		2N6515, 2N6517 2N6520		

### SWITCHING CHARACTERISTICS

Turn-On Time ( $V_{CC} = 100 \text{ Vdc}$ , $V_{BE(off)} = 2.0 \text{ Vdc}$ , $I_C = 50 \text{ mA}$ , $I_{B1} = 10 \text{ mA}$ )	$t_{on}$	–	200	$\mu\text{s}$
Turn-Off Time ( $V_{CC} = 100 \text{ Vdc}$ , $I_C = 50 \text{ mA}$ , $I_{B1} = I_{B2} = 10 \text{ mA}$ )	$t_{off}$	–	3.5	$\mu\text{s}$

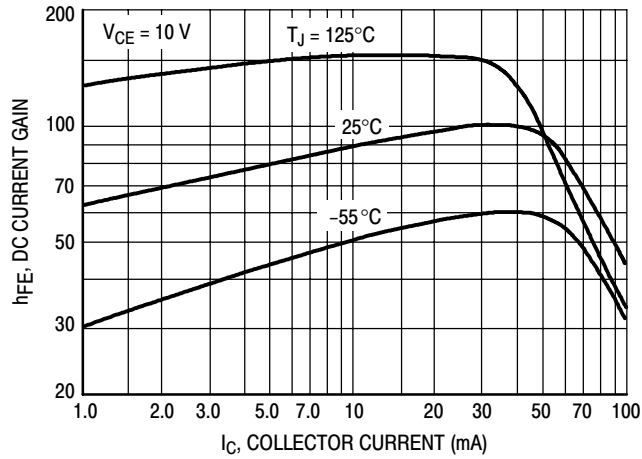
1. Pulse Test: Pulse Width  $\leq 300 \mu\text{s}$ , Duty Cycle  $\leq 2.0\%$ .

### ORDERING INFORMATION

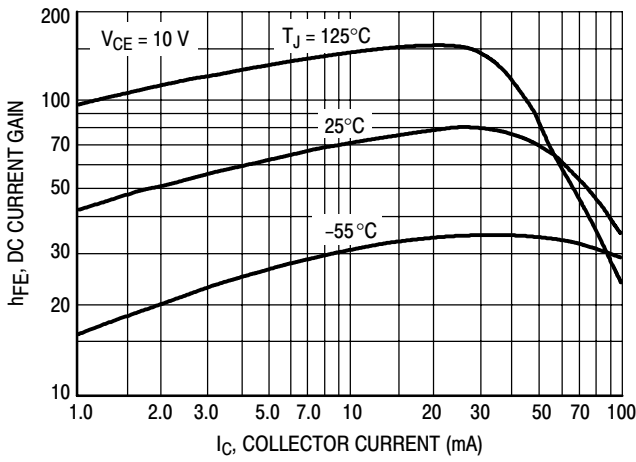
Device	Package	Shipping <sup>†</sup>
2N6515	TO-92	5000 Unit / Bulk
2N6515RLRM	TO-92	2000 Tape & Ammo Box
2N6517	TO-92	5000 Unit / Bulk
2N6517RLRA	TO-92	2000 Tape & Reel
2N6517RLRP	TO-92	2000 Tape & Ammo Box
2N6520RLRA	TO-92	2000 Tape & Reel
2N6520RLRAG	TO-92 (Pb-Free)	2000 Tape & Reel

<sup>†</sup>For information on tape and reel specifications, including part orientation and tape sizes, please refer to our Tape and Reel Packaging Specifications Brochure, BRD8011/D.

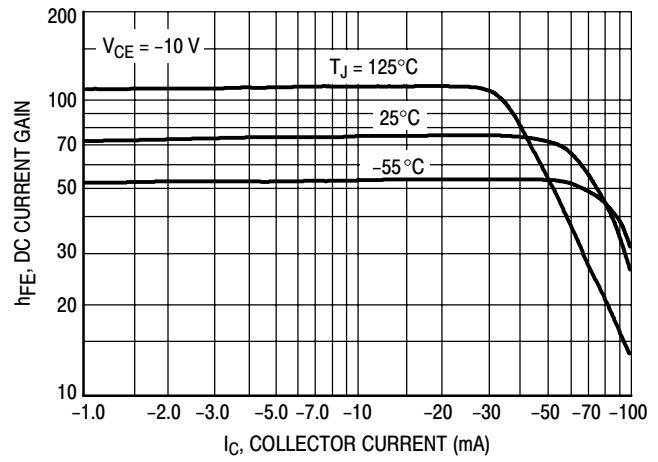
# 2N6515, 2N6517, 2N6520



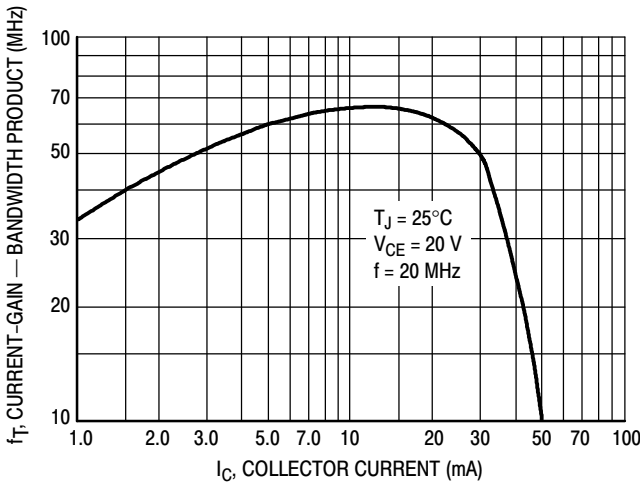
**Figure 1. DC Current Gain  
NPN 2N6515**



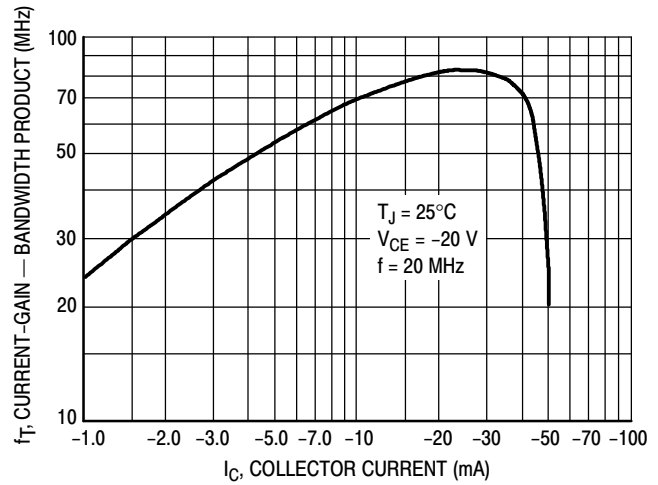
**Figure 2. DC Current Gain  
NPN 2N6517**



**Figure 3. DC Current Gain  
PNP 2N6520**

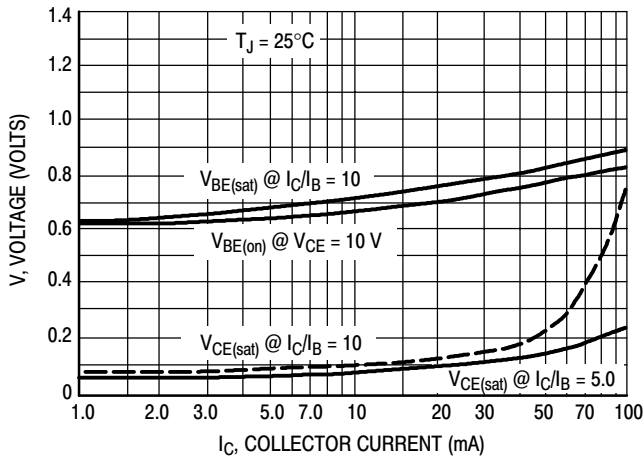


**Figure 4. Current-Gain - Bandwidth Product  
NPN 2N6515, 2N6517**

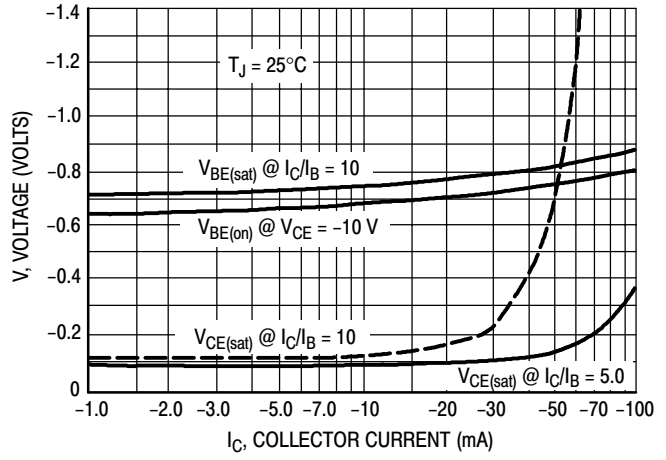


**Figure 5. Current-Gain - Bandwidth Product  
PNP 2N6520**

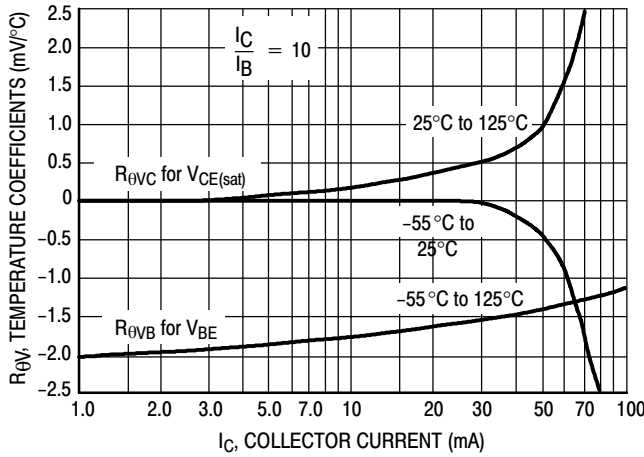
## 2N6515, 2N6517, 2N6520



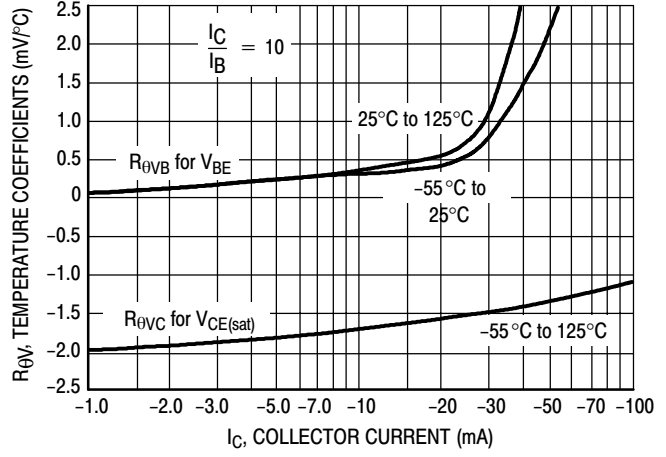
**Figure 6. "On" Voltages  
NPN 2N6515, 2N6517**



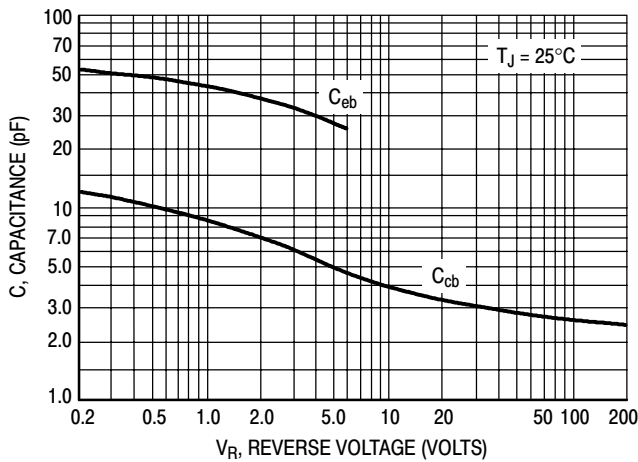
**Figure 7. "On" Voltages  
PNP 2N6520**



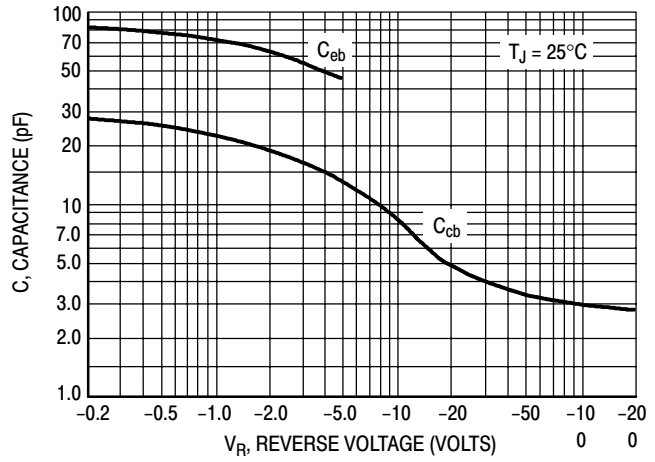
**Figure 8. Temperature Coefficients  
NPN 2N6515, 2N6517**



**Figure 9. Temperature Coefficients  
PNP 2N6520**

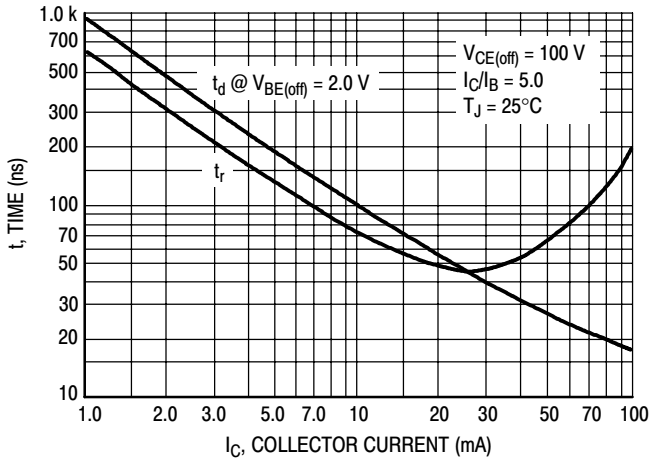


**Figure 10. Capacitance  
NPN 2N6515, 2N6517**

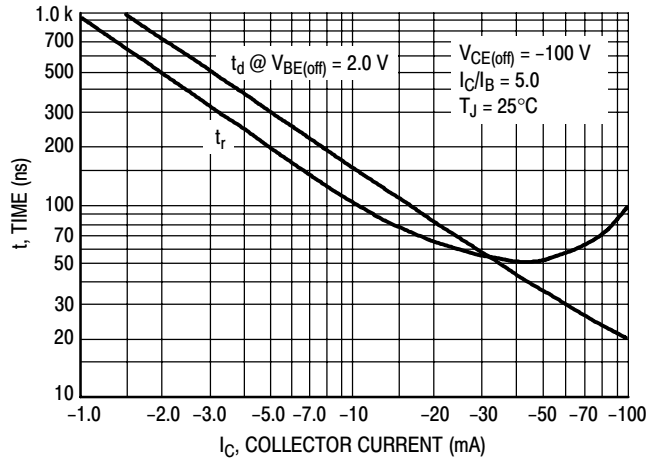


**Figure 11. Capacitance  
PNP 2N6520**

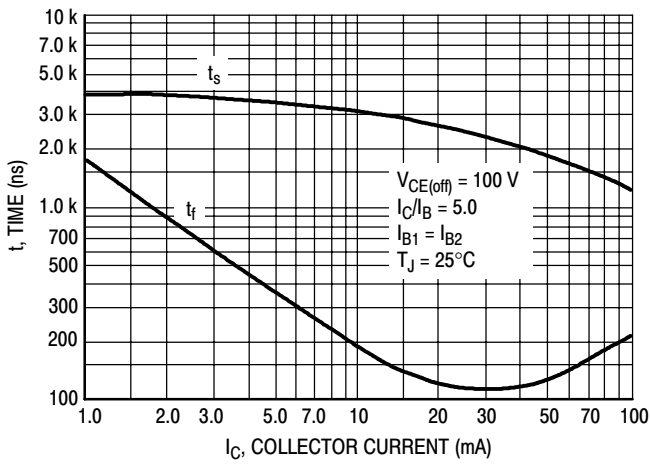
## 2N6515, 2N6517, 2N6520



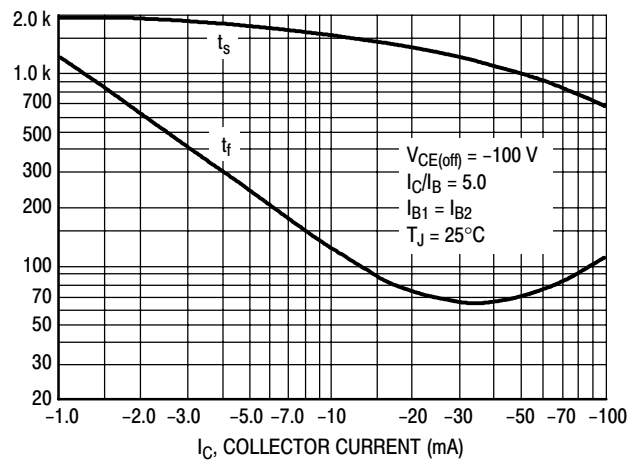
**Figure 12. Turn-On Time  
NPN 2N6515, 2N6517**



**Figure 13. Turn-On Time  
PNP 2N6520**

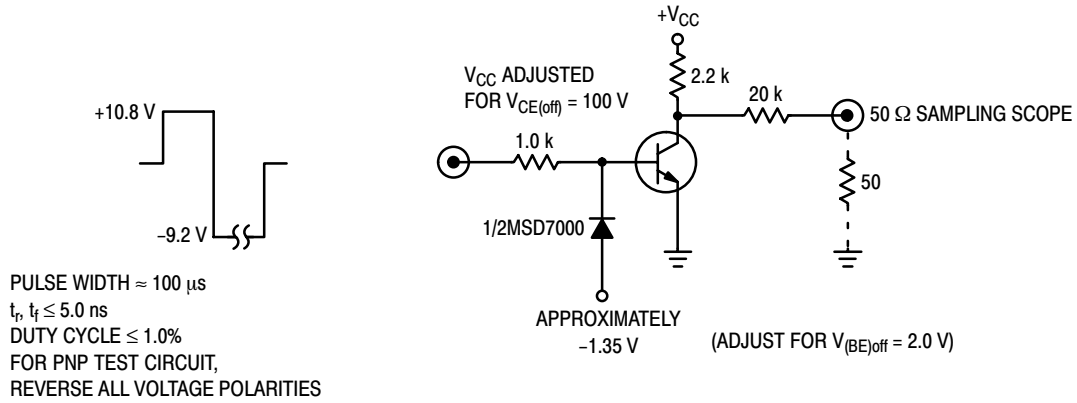


**Figure 14. Turn-Off Time  
NPN 2N6515, 2N6517**

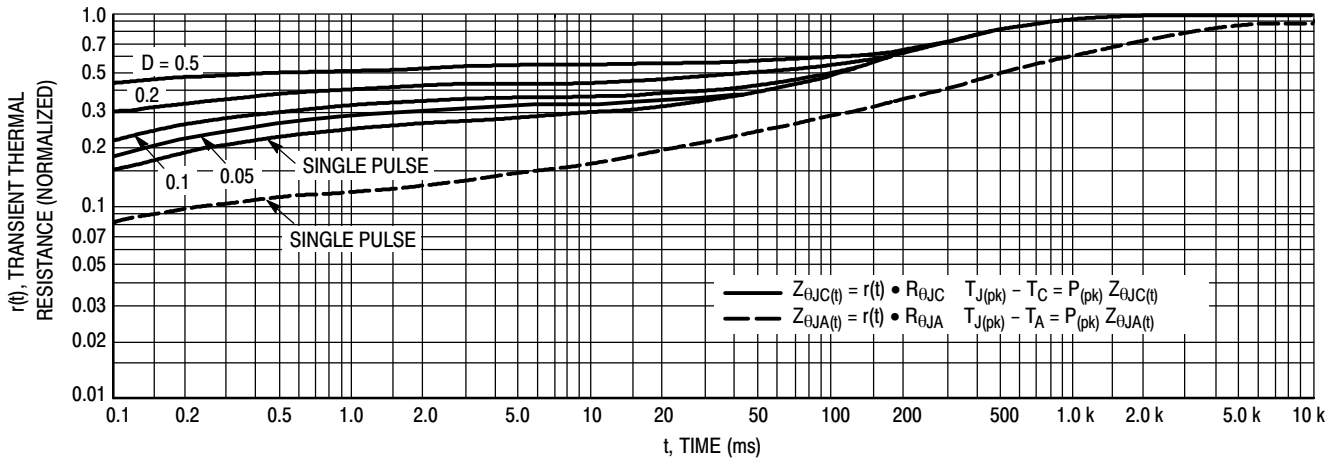


**Figure 15. Turn-Off Time  
PNP 2N6520**

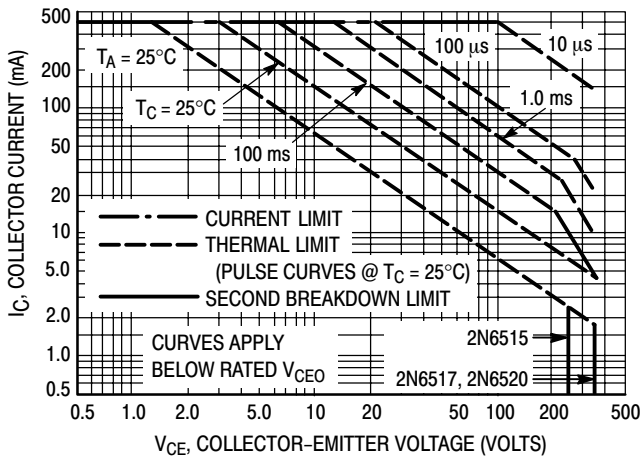
## 2N6515, 2N6517, 2N6520



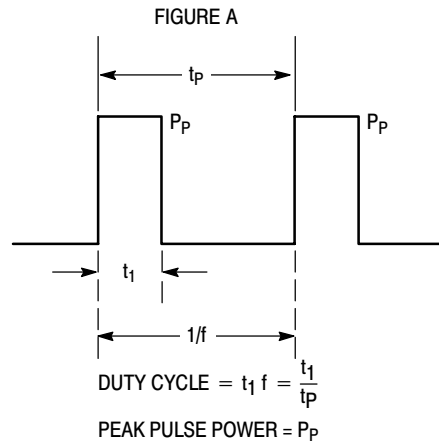
**Figure 16. Switching Time Test Circuit**



**Figure 17. Thermal Response**



**Figure 18. Active Region Safe Operating Area**

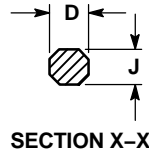
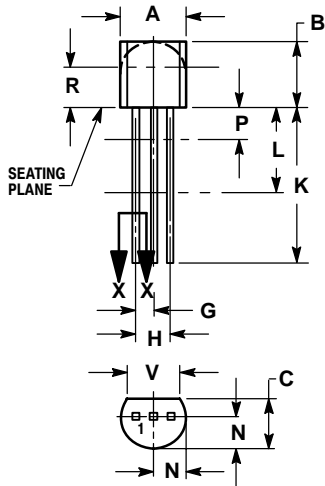


**Design Note: Use of Transient Thermal Resistance Data**

# 2N6515, 2N6517, 2N6520

## PACKAGE DIMENSIONS

TO-92  
CASE 29-11  
ISSUE AL




### NOTES:

1. DIMENSIONING AND TOLERANCING PER ANSI Y14.5M, 1982.
2. CONTROLLING DIMENSION: INCH.
3. CONTOUR OF PACKAGE BEYOND DIMENSION R IS UNCONTROLLED.
4. LEAD DIMENSION IS UNCONTROLLED IN P AND BEYOND DIMENSION K MINIMUM.

DIM	INCHES		MILLIMETERS	
	MIN	MAX	MIN	MAX
A	0.175	0.205	4.45	5.20
B	0.170	0.210	4.32	5.33
C	0.125	0.165	3.18	4.19
D	0.016	0.021	0.407	0.533
G	0.045	0.055	1.15	1.39
H	0.095	0.105	2.42	2.66
J	0.015	0.020	0.39	0.50
K	0.500	---	12.70	---
L	0.250	---	6.35	---
N	0.080	0.105	2.04	2.66
P	---	0.100	---	2.54
R	0.115	---	2.93	---
V	0.135	---	3.43	---

### STYLE 1:

1. EMITTER
2. BASE
3. COLLECTOR

ON Semiconductor and  are registered trademarks of Semiconductor Components Industries, LLC (SCILLC). SCILLC reserves the right to make changes without further notice to any products herein. SCILLC makes no warranty, representation or guarantee regarding the suitability of its products for any particular purpose, nor does SCILLC assume any liability arising out of the application or use of any product or circuit, and specifically disclaims any and all liability, including without limitation special, consequential or incidental damages. "Typical" parameters which may be provided in SCILLC data sheets and/or specifications can and do vary in different applications and actual performance may vary over time. All operating parameters, including "Typicals" must be validated for each customer application by customer's technical experts. SCILLC does not convey any license under its patent rights nor the rights of others. SCILLC products are not designed, intended, or authorized for use as components in systems intended for surgical implant into the body, or other applications intended to support or sustain life, or for any other application in which the failure of the SCILLC product could create a situation where personal injury or death may occur. Should Buyer purchase or use SCILLC products for any such unintended or unauthorized application, Buyer shall indemnify and hold SCILLC and its officers, employees, subsidiaries, affiliates, and distributors harmless against all claims, costs, damages, and expenses, and reasonable attorney fees arising out of, directly or indirectly, any claim of personal injury or death associated with such unintended or unauthorized use, even if such claim alleges that SCILLC was negligent regarding the design or manufacture of the part. SCILLC is an Equal Opportunity/Affirmative Action Employer. This literature is subject to all applicable copyright laws and is not for resale in any manner.

### PUBLICATION ORDERING INFORMATION

**LITERATURE FULFILLMENT:**  
Literature Distribution Center for ON Semiconductor  
P.O. Box 5163, Denver, Colorado 80217 USA  
**Phone:** 303-675-2175 or 800-344-3860 Toll Free USA/Canada  
**Fax:** 303-675-2176 or 800-344-3867 Toll Free USA/Canada  
**Email:** orderlit@onsemi.com

**N. American Technical Support:** 800-282-9855 Toll Free  
USA/Canada

**Japan:** ON Semiconductor, Japan Customer Focus Center  
2-9-1 Kamimeguro, Meguro-ku, Tokyo, Japan 153-0051  
**Phone:** 81-3-5773-3850

**ON Semiconductor Website:** <http://onsemi.com>

**Order Literature:** <http://www.onsemi.com/litorder>

For additional information, please contact your local Sales Representative.