

K50 Pro Touch Audible Button with IO-Link

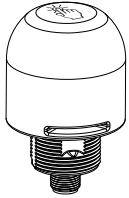

Datasheet

50 mm IO-Link Controlled Multicolor RGB Indicator with Audible and Touch Button Output



Standard Model



Compact Model

- Excellent immunity to false triggering by water spray, detergents, oils, and other foreign materials
- IO-Link gives full access to color, flashing, rotating, and dimming settings as well as advanced audible selections and LED control
- Output settings, including on and off delays, output function, and output state are also available with IO-Link
- Integral audible can be used as standalone indicator or as an input to touch conditions
- 14 different tones available including intensity and customization
- 97 dB maximum sound intensity
- Rated IP67 and IP65
- Ergonomically designed to eliminate hand, wrist, and arm stresses associated with repeated switch operation; no physical force required to operate
- 18 V DC to 30 V DC operation
- Can be actuated with bare hands or gloves; adjustable sensitivity using Pro Editor software
- Compact models available for lower profile applications

Models

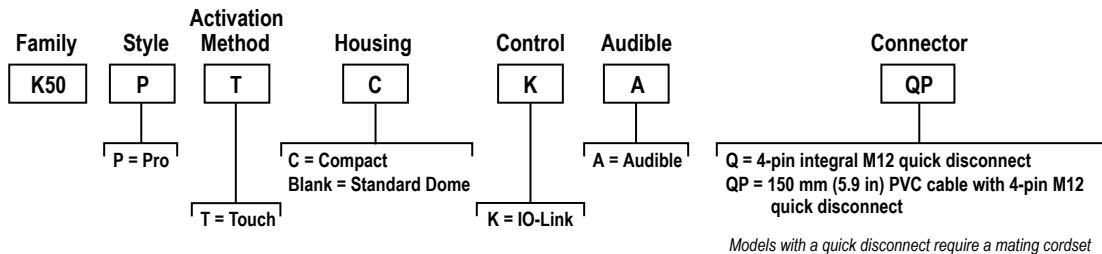

Wiring Diagram

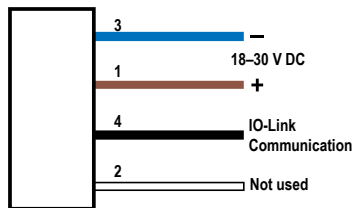

- Key**
- 1 = Brown
 - 2 = White
 - 3 = Blue
 - 4 = Black

IO-Link®

IO-Link® is a point-to-point communication link between a master device and a sensor and/or light. It can be used to automatically parameterize sensors or lights and to transmit process data. For the latest IO-Link protocol and specifications, please visit www.io-link.com.

For the latest IODD files, please refer to the Banner Engineering Corp website at: www.bannerengineering.com.

IO-Link Process Data In (Device to Master)

Use process data to read the device output state. When the device is in Four State Full Logic mode, use process data to read the device logic state in addition to the output state.

Name	Description
Output State	Output state follows touch button input
Device State	Current state (State 1, State 2, State 3, State 4). Only available with Operation Mode set to Four State Full Logic or Multicolor



IO-Link Process Data Out (Master to Device)

Use process data out to define device states. Use parameter data to define device modes, states, touch settings, output settings, custom audible settings, and custom colors.

Advanced Mode

Use process data to control delays, color, intensity, flash, audible tones, and other animation types. Process data is also used to control the sequence value dynamically. Use parameter data to create custom colors, intensity, speeds, and to define output and touch settings.

Four State Full Logic Mode

Use process data to define the Job Input state and to read the touch button state and device state (State 1, State 2, State 3, State 4). See below for more information about how to achieve legacy logic types (C, D, E, and H). Use parameter data to change color, intensity, flash, speed, select animation type, select audible tones, and define output settings.

Multicolor Mode

Use process data to activate the defined device state. Use parameter data to define output settings, control delays, color, intensity, flash, audible tones, and other animation types for State 1, State 2, State 3, and State 4.

Definitions for device states in Advanced Mode, Four State Full Logic Mode, and Multicolor Mode	
Name	Description
Animation Type	
Off	Indicator is off
Steady	Color 1 is solid on at defined intensity
Flash	Color 1 flashes at defined speed, color intensity, and pattern
Two Color Flash	Color 1 and Color 2 flash alternately at defined speed, color intensities, and pattern
50/50	Color 1 is displayed on 50% of the indicator and Color 2 is displayed on the other 50% of the indicator at the defined color intensities
50/50 Rotate	Color 1 is displayed on 50% of the indicator and Color 2 is displayed on the other 50% of the indicator while rotating at the defined speed, color intensities, and rotational direction
Chase	Color 1 is displayed as a single spot against the background of Color 2 while rotating at the defined speed, color intensities, and rotational direction
Intensity Sweep	Color 1 repeatedly increases and decreases intensity between 0% to 100% at defined speed and color intensity
Color Sweep	Color 1 and Color 2 transition alternately at defined speed and color intensities
Sequence	Color 1 increments against the background of Color 2 at defined Dynamic or Static Sequence Value (Advanced mode and other modes respectively)
Animation Direction	Defines the direction of rotation for the 50/50 rotate, chase, and sequence animations (CW or CCW)
Animation Pattern	Defines the flash pattern for flash and two color flash animations (normal, strobe, three pulse, SOS, or random)
Animation Speed	Defines the animation speed (slow, medium, fast, or custom)
Off Delay Type	Defines if the Off Delay should be measured from when the conditions for the State began (Leading Edge) or from when the conditions ended (Trailing Edge)
Off Delay (ms)	The duration of the animation Off Delay. Leading Edge Off Delays can be used to ensure the animation is active for at least a minimum amount of time.
Dynamic/Static Sequence Value	Defines the span of Color 1 in the Sequence animation [0-255]. 0 means no portion of the animation will be Color 1, and it increases in a circular manner to 255 which indicates the full circumference will be Color 1. In Advanced Mode, this is in process data and is called Dynamic Sequence Value. In the other modes, this is in parameter data and is called Static Sequence Value.
Sequence Shift	Shifts the beginning of the sequence animation to the specified LED (LED1 at 12 o'clock continuing in the direction indicated by the Animation Direction parameter)
Color 1	Defines Color 1 of defined animation
Color 1 Intensity	Defines the intensity of Color 1 in the animation (high, medium, low, off, or custom)
Color 2	Defines Color 2 of defined animation
Color 2 Intensity	Defines the intensity of Color 2 in the animation (high, medium, low, off, or custom)
Audible Feedback	Defines the type of audible feedback
Audible Volume	Defines the volume of the audible tone
Audible Type	Defines the type of audible tone played

Four State Full Logic Mode State Descriptions

Use process data job input and the touch button input to dictate which one of these states the device should be in. Use parameter data to define the state characteristics.

State 1: Process Data job input off and touch button inactive

State 2: Process Data job input on and touch button inactive

State 3: Process Data job input off and touch button active

State 4: Process Data job input on and touch button active

Four State Full Logic			Legacy Logic Definitions (Four State Full Logic)	
	Not Actuated	Actuated	Logic	Description
No Input	State 1	State 3	C Logic	State 1 is Off. State 2 is Color 1/Job Input. State 3 is Color 2/Acknowledge. State 4 is defined the same as State 3
Job Input	State 2	State 4	D Logic	State 1 is Off. State 2 is Color 1/Job Input. State 3 is Off. State 4 is defined the same as State 2
			E Logic	State 1 is Off. State 2 is Color 1/Job Input. State 3 is Color 2/Mispick. State 4 is defined the same as State 2
			H Logic	State 1 is power, defined as Color 1. State 2 is defined the same as State 1. State 3 is Color 2/Sense. State 4 is defined the same as State 3

LED Control Mode

Use process data to define the color and intensity of each individual LED. Use parameter data to define customer colors and intensities. LED1 is oriented at the 12 o'clock position continuing clockwise through LED8 near 11 o'clock position.

Name	Description
LED 1 Color...LED 8 Color	Defines the color of the designated LED.
LED 1 Intensity...LED 8 Intensity	Defines the intensity of the designated LED [Values: 0-10]
Audible Feedback	Defines the type of audible feedback
Audible Volume	Defines the volume of the audible tone
Audible Type	Defines the type of audible tone played

Demo Mode

Cycles through color spectrum, 50/50 rotate, intensity sweep, and sequence mode. Touch button speeds cycle rate up or down (can be either Momentary or Latching). Touch button initiates state showing individually colored LEDs. When set to demo mode, the device will cycle through the defined sequence when power is applied regardless of its connection to an IO-Link master.

Touch Settings

Use Parameter Data to define the following settings.

Setting	Description
Touch Sensitivity	Defines the sensitivity of the touch button as either Standard, High or Low. Low sensitivity resists false activation. High sensitivity can be used for improved touch response (Touch models only)
Function	Latching or Momentary Options. Momentary function toggles output on only during a touch button input. Latching function toggles output on or off for each touch button input
Mute Enable	Turning on mute disables the touch button input
On Delay (ms)	Length of time the button needs to be pressed or the sensor needs to be blocked to trigger an active state. 0-60,000 ms

Output Settings

Use Parameter Data to define the following settings.

Setting	Description
Output State	Normally Open or Normally Closed. Normally Open turns the output on with a touch button input. Normally Closed turns the output off with a touch, optical sensor, or push button input
Off Delay Type	Leading Edge or Trailing Edge. Leading Edge delays will begin once a touch button has been sensed. Trailing edge delays will begin once the touch, optical sensor, or push button has been released
Off Delay (ms)	Length of time before the output state returns to a touch button inactive state after the button has been released or sensor has been unblocked. 0-60,000 ms

Custom Audible Settings

Use Parameter Data to define the following settings.

Setting	Description
Custom Audible Type	Defines the type of audible tone for the custom audible tone
Sweep Type	Defines the direction of the sweep audible tone, if selected
Frequency 1	Defines a frequency that will act as the start/end frequency for sweeps, or a set frequency for tones/beeps
Frequency 2	Defines a frequency that will act as the start/end frequency for sweeps, or a set frequency for tones/beeps

Specifications

Supply Voltage

18 V DC to 30 V DC

Supply Current

120 mA maximum current at 18 V DC (exclusive of load)
104 mA maximum current at 24 V DC (exclusive of load)
101 mA maximum current at 30 V DC (exclusive of load)

Supply Protection Circuitry

Protected against reverse polarity and transient voltages

Audible Characteristics

Values shown apply to continuous tone. Frequency and intensity response will vary depending on the Audible Tone selected.

Audible Intensity

Maximum intensity at 2.9 kHz: 97 dB at 1 m
Minimum intensity at 2.9 KHz: 94 dB at 1 m

Connections

Integral 4-pin M12 male quick-disconnect connector or 150 mm (6 in) PVC cable with a 4-pin M12 male quick-disconnect connector, depending on model
Models with a quick disconnect require a mating cordset

Storage

-40 °C to +70 °C (-40 °F to +158 °F)

IO-Link Interface

Supports Smart Sensor Profile: No
Baud Rate: 38400 bps (COM2)
Process Data In: 16 bits (2 bytes)
Process Data Out: 80 bits (10 bytes)
IODD Files: Provides all programming options, plus additional functionality

Touch Response Time

Input Response: 5 ms maximum
 Touch Response: 300 ms maximum
 (Standard Sensitivity touch response)

Touch Dwell Time

If touch dwells for longer than 60 seconds, the output will revert to the untouched state

Operating Conditions

-40 °C to +50 °C (-40 °F to +122 °F)
Humidity: 90% at +50 °C maximum relative humidity (non-condensing)

Environmental Rating

IP67, IP65

Mounting

M30 x 1.5 threaded base, maximum torque 4.5 N-m (40 in-lbf)

Construction

Base, Dome, and Nut: Polycarbonate

Vibration and Mechanical Shock

Meets IEC 60068-2-6 requirements (Vibration: 10 Hz to 55 Hz, 1.0 mm amplitude, 5 minutes sweep, 30 minutes dwell)
 Meets IEC 60068-2-27 requirements (Shock: 30G 11 ms duration, half sine wave)

Certifications



Banner Engineering Europe Park Lane, Culliganlaan 2F bus 3, 1831 Diegem, BELGIUM



Turck Banner LTD Blenheim House, Blenheim Court, Wickford, Essex SS11 8YT, Great Britain

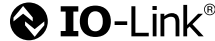

Default Indicator Characteristics

Color	Dominant Wavelength (nm) or Color Temperature (CCT)	Color Coordinates ¹		Lumen Output (Typical at 25 °C) ²
		x	y	
Green	522	0.154	0.700	16.5
Red	620	0.689	0.309	8.3
Yellow	576	0.477	0.493	23.8
Blue	466	0.140	0.054	4.6
White	5700K	0.328	0.337	25.1
Cyan	493	0.170	0.340	18.4
Magenta	-	0.379	0.172	11.1
Amber	589	0.556	0.420	15.7
Rose	-	0.515	0.220	9.1
Lime Green	562	0.388	0.561	21.4
Sky Blue	486	0.155	0.247	19.5
Orange	599	0.616	0.370	12.1
Violet	-	0.217	0.089	9.7
Spring Green	508	0.177	0.536	17.0

Required Overcurrent Protection



WARNING: Electrical connections must be made by qualified personnel in accordance with local and national electrical codes and regulations.

Overcurrent protection is required to be provided by end product application per the supplied table. Overcurrent protection may be provided with external fusing or via Current Limiting, Class 2 Power Supply. Supply wiring leads < 24 AWG shall not be spliced. For additional product support, go to www.bannerengineering.com.

Supply Wiring (AWG)	Required Overcurrent Protection (Amps)
20	5.0
22	3.0
24	2.0
26	1.0
28	0.8
30	0.5

Dimensions

All measurements are listed in millimeters [inches], unless noted otherwise.

Standard Models

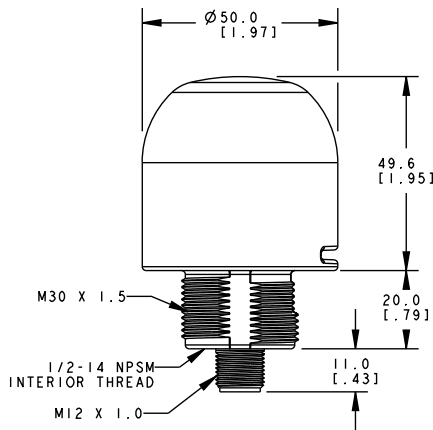

Compact Models

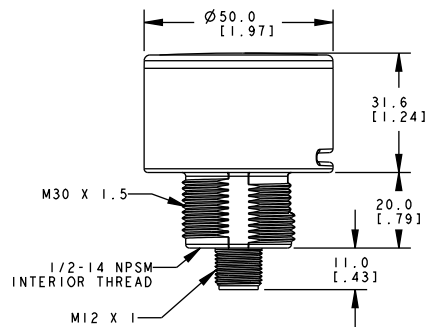

¹ Refer to the CIE 1931 (x,y) Chromaticity Diagram to show equivalent color with indicated color coordinates. Actual coordinates may differ ± 5%.
² Values shown apply to dome models only. Compact models are 20% lower.

Accessories

Cordsets

4-Pin Threaded M12 Cordsets—Double Ended				
Model	Length	Style	Dimensions	Pinout
MQDEC-401SS	0.31 m (1 ft)	Male Straight/Female Straight		Female
MQDEC-403SS	0.91 m (2.99 ft)			
MQDEC-406SS	1.83 m (6 ft)			Male
MQDEC-412SS	3.66 m (12 ft)			
MQDEC-420SS	6.10 m (20 ft)			
MQDEC-430SS	9.14 m (30.2 ft)			
MQDEC-450SS	15.2 m (49.9 ft)			<p>1 = Brown 2 = White 3 = Blue 4 = Black</p>

4-Pin Threaded M12 Cordsets—Double Ended, Oil Resistant				
Model	Length	Style	Dimensions	Pinout
MQDEC-401SS-PUR	0.3 m (0.98 ft)	Male Straight/Female Straight		Female
MQDEC-403SS-PUR	1 m (3.28 ft)			
MQDEC-406SS-PUR	2 m (6.56 ft)			Male
MQDEC-415SS-PUR	5 m (16.4 ft)			
MQDEC-430SS-PUR	10 m (32.8 ft)			

4-Pin Threaded M12 Cordsets—Double Ended, Washdown, Stainless Steel				
Model	Length	Style	Dimensions	Pinout
MQDEC-WDSS-401SS	0.31 m (1 ft)	Male Straight/Female Straight		Female
MQDEC-WDSS-403SS	0.91 m (2.99 ft)			
MQDEC-WDSS-406SS	1.83 m (6 ft)			Male
MQDEC-WDSS-412SS	3.66 m (12 ft)			
				<p>1 = Brown 2 = White 3 = Blue 4 = Black</p>

Brackets

SMB30A

- Right-angle bracket with curved slot for versatile orientation
- Clearance for M6 (¼ in) hardware
- Mounting hole for 30 mm sensor
- 12-ga. stainless steel

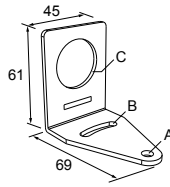

Hole center spacing: A to B=40
Hole size: A=ø 6.3, B= 27.1 x 6.3, C=ø 30.5

SMB30FA

- Swivel bracket with tilt and pan movement for precise adjustment
- Mounting hole for 30 mm sensor
- 12-ga. 304 stainless steel
- Easy sensor mounting to extrude rail T-slot
- Metric and inch size bolt available

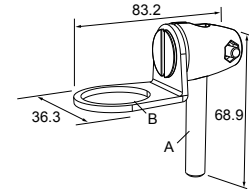

Bolt thread: SMB30FA, A= 3/8 - 16 x 2 in; SMB30FAM10, A= M10 - 1.5 x 50
Hole size: B= ø 30.1

SMB30FVK

- V-clamp, flat bracket and fasteners for mounting to pipe or extensions
- Clamp accommodates 28 mm dia. tubing or 1 in. square extrusions
- 30 mm hole for mounting sensors

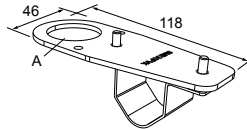

Hole size: A= ø 31

SMB30MM

- 12-ga. stainless steel bracket with curved mounting slots for versatile orientation
- Clearance for M6 (¼ in) hardware
- Mounting hole for 30 mm sensor

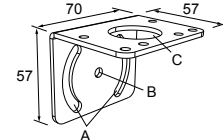

Hole center spacing: A = 51, A to B = 25.4
Hole size: A = 42.6 x 7, B = ø 6.4, C = ø 30.1

SMB30RAVK

- V-clamp, right-angle bracket and fasteners for mounting sensors to pipe or extrusion
- Clamp accommodates 28 mm dia. tubing or 1 in. square extrusions
- 30 mm hole for mounting sensors

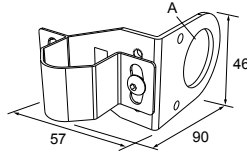

Hole size: A = ø 30.5

SMB30SC

- Swivel bracket with 30 mm mounting hole for sensor
- Black reinforced thermoplastic polyester
- Stainless steel mounting and swivel locking hardware included

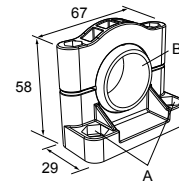

Hole center spacing: A=ø 50.8
Hole size: A=ø 7.0, B=ø 30.0

SMBAMS30P

- Flat SMBAMS series bracket
- 30 mm hole for mounting sensors
- Articulation slots for 90°+ rotation
- 12-ga. 300 series stainless steel

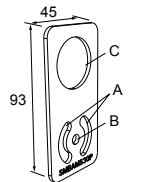

Hole center spacing: A=26.0, A to B=13.0
Hole size: A=26.8 x 7.0, B=ø 6.5, C=ø 31.0

SMBAMS30RA

- Right-angle SMBAMS series bracket
- 30 mm hole for mounting sensors
- Articulation slots for 90°+ rotation
- 12-ga. (2.6 mm) cold-rolled steel

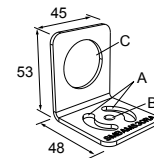

Hole center spacing: A=26.0, A to B=13.0
Hole size: A=26.8 x 7.0, B=ø 6.5, C=ø 31.0

LMB30LPC

- For 28 mm tubular racking
- LMB30LP attached to clamp bracket
- Toolless mount to racking
- 30 mm mounting hole

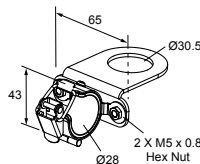

LMB30LP

- Low profile
- 30 mm mounting hole
- 300 series stainless steel

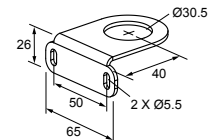

Banner Engineering Corp. Limited Warranty

Banner Engineering Corp. warrants its products to be free from defects in material and workmanship for one year following the date of shipment. Banner Engineering Corp. will repair or replace, free of charge, any product of its manufacture which, at the time it is returned to the factory, is found to have been defective during the warranty period. This warranty does not cover damage or liability for misuse, abuse, or the improper application or installation of the Banner product.

THIS LIMITED WARRANTY IS EXCLUSIVE AND IN LIEU OF ALL OTHER WARRANTIES WHETHER EXPRESS OR IMPLIED (INCLUDING, WITHOUT LIMITATION, ANY WARRANTY OF MERCHANTABILITY OR FITNESS FOR A PARTICULAR PURPOSE), AND WHETHER ARISING UNDER COURSE OF PERFORMANCE, COURSE OF DEALING OR TRADE USAGE.

This Warranty is exclusive and limited to repair or, at the discretion of Banner Engineering Corp., replacement. **IN NO EVENT SHALL BANNER ENGINEERING CORP. BE LIABLE TO BUYER OR ANY OTHER PERSON OR ENTITY FOR ANY EXTRA COSTS, EXPENSES, LOSSES, LOSS OF PROFITS, OR ANY INCIDENTAL, CONSEQUENTIAL OR SPECIAL DAMAGES RESULTING FROM ANY PRODUCT DEFECT OR FROM THE USE OR INABILITY TO USE THE PRODUCT, WHETHER ARISING IN CONTRACT OR WARRANTY, STATUTE, TORT, STRICT LIABILITY, NEGLIGENCE, OR OTHERWISE.**

Banner Engineering Corp. reserves the right to change, modify or improve the design of the product without assuming any obligations or liabilities relating to any product previously manufactured by Banner Engineering Corp. Any misuse, abuse, or improper application or installation of this product or use of the product for personal protection applications when the product is identified as not intended for such purposes will void the product warranty. Any modifications to this product without prior express approval by Banner Engineering Corp will void the product warranties. All specifications published in this document are subject to change; Banner reserves the right to modify product specifications or update documentation at any time. Specifications and product information in English supersede that which is provided in any other language. For the most recent version of any documentation, refer to: www.bannerengineering.com.

For patent information, see www.bannerengineering.com/patents.

FCC Part 15

This device complies with Part 15 of the FCC Rules. This equipment generates, uses, and can radiate radio frequency energy and, if not installed and used in accordance with the instruction manual, may cause harmful interference to radio communications. Operation is subject to the following two conditions: 1) This device may not cause harmful interference; and 2) This device must accept any interference received, including interference that may cause undesired operation.

Industry Canada

This device complies with CAN ICES-3 (B)/NMB-3(B). Operation is subject to the following two conditions: 1) This device may not cause harmful interference; and 2) This device must accept any interference received, including interference that may cause undesired operation.

Cet appareil est conforme à la norme NMB-3(B). Le fonctionnement est soumis aux deux conditions suivantes : (1) ce dispositif ne peut pas occasionner d'interférences, et (2) il doit tolérer toute interférence, y compris celles susceptibles de provoquer un fonctionnement non souhaité du dispositif.