

環保物料專用
RoHS compliant

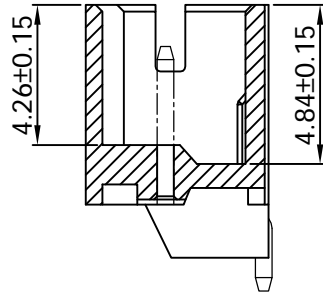

Section A-A

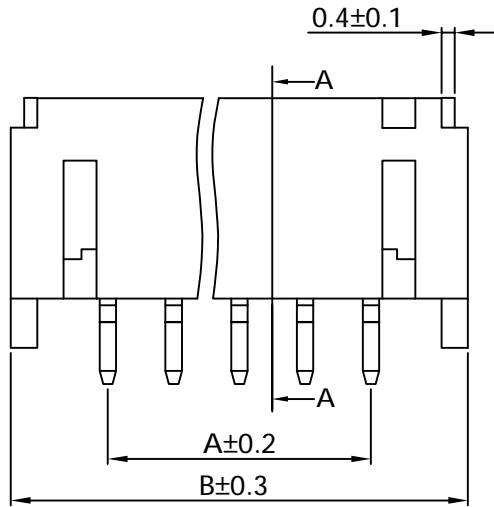
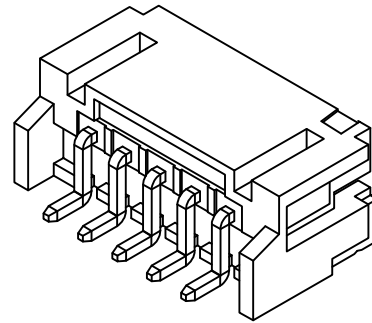

Specifications
 Current Rating :2A AC,DC
 Voltage rating :100V AC,DC
 Temperature range :−25°C~+85°C
 Contact resistance :20mΩMax
 Insulation resistance :1000MΩMin
 Withstanding voltage :800 V AC/minute
 Pin Material :Brass
 Finished :Tin-plated
 Housing Mateial :Nylon-6T,UL94 V -0
 Color :BLACK

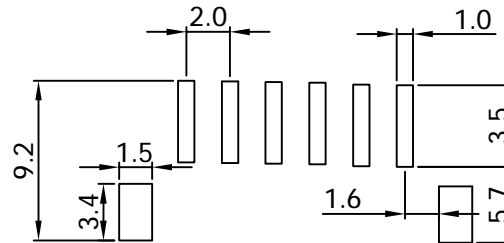
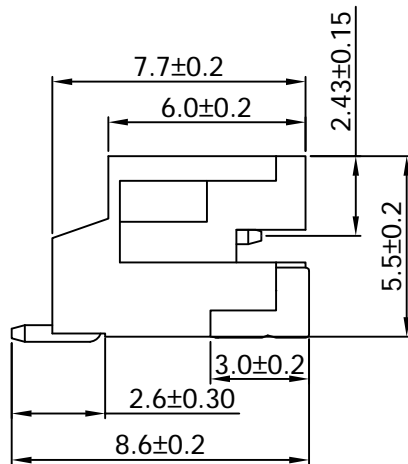
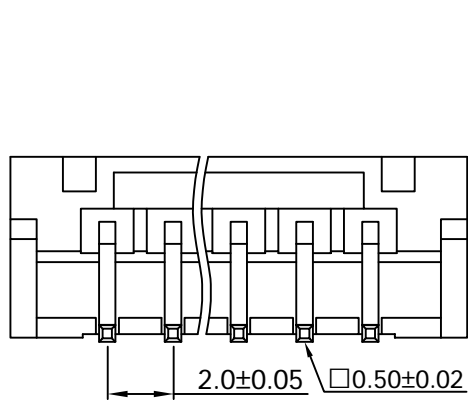

P.C.B Hole Layout

Circuits	Dimension mm	
	A	B
02	2.00	8.00
03	4.00	10.00
04	6.00	12.00
05	8.00	14.00
06	10.00	16.00
07	12.00	18.00
08	14.00	20.00
09	16.00	22.00
10	18.00	24.00
11	20.00	26.00
12	22.00	28.00
13	24.00	30.00
14	26.00	32.00
15	28.00	34.00
16	30.00	36.00



DESCRIPTION(內容):
2.0mm Wafer 90° SMT

DRAWN(製圖):
Tom Liu

CHECKED(確認):
Jack Wu

APPROVAL(核准):
Kane He

GENERAL TOLERANCE

LINEAR ANGLES

X.: ±0.30 X°: ±5.0°

X.X: ±0.20 X.X°: ±3.0°

X.XX: ±0.15 X.XX°: ±2.0°

X.XXX: ±0.10 X.XXX°: ±1.0°

REV:

A/1

UNIT:

mm

SHEET:

1/1

REV

1

2

3

4

DESCRIPTION

ORIGINAL

DATE

Aug-16-2019

PART NO:
(料號) CW2001-XXT-H01-BD-A

DWG NO(圖號): KWRD1908016-007

A4

SCALE(比例):
1:XX

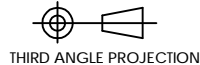

THIRD ANGLE PROJECTION