

SFT-10 LED Chipset in SMT and Starboard Configurations

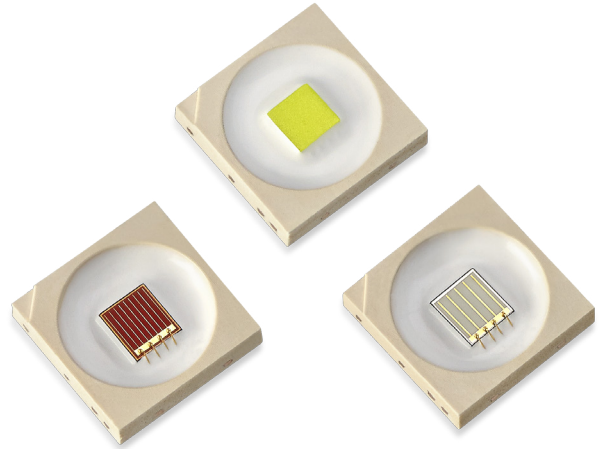

Table of Contents

| | |
|-------------------------------------------------|-------|
| Technology Overview | 2 |
| Understanding SMT Test Specifications | 2 |
| Ordering / Bin Kits | 3 - 5 |
| Standard Test Condition | 6 |
| Optical & Electrical Characteristics | 7 |
| Absolute Maximums | 8 |
| Characterization | 9-12 |
| Thermal Resistance | 13 |
| Mechanical Dimensions | 13-15 |
| Solder Profile | 16 |
| Packing and Shipping Information | 17-18 |
| History of Changes | 19 |

Features:

- Matched R/CG/B Chipset with 1.0mm² emitting area designed for mid to high current-density 0.2" / 0.3" Pico projection applications
- Thermally efficient SMT Package: $R_{TH\ J-C} = 3.0^{\circ} C/W$
- Available either in "Standard" (SMT) or Pre-Mounted "Starboard" Configurations
- Available "Starboard" Packaging Configuration allows ease of evaluation and/or immediate system integration
- 100% surface emission for high collection efficiency and low optical losses
- Wide color gamut with the most desirable dominant wavelengths:
Red-Amber 613 nm, Converted Green (filtered spectrum) 555nm, and Blue 455 nm
- Single emitting area per color allows for efficiency of collection with simplified optics
- Environmentally friendly: RoHS and REACH compliant
- Characterized correlation between "Test" and real-world Display applications are provided.

Applications

- Specifically engineered for stand alone, embedded, or battery-assisted projection display applications.
- Entertainment / Stage Lighting
- Medical / Life Science
- Industrial
- Transportation / Beacons
- High performance illumination

Technology Overview

Luminus Devices' SFT series of illuminators is an innovative small form factor solid-state light source created for applications requiring high current density in a small area. With its thermally efficient package, the SFT-10 chipset allows the end-product to deliver all the benefits of small, high performing solid state light sources.

The SFT series is environmentally friendly (Mercury-free), enables instant start and re-start with no wait time, high reliability, and long life requiring no end-user or field replacement. Response time is quick enabling frame-by-frame color control with compatible ASIC control chipsets for projection applications.

Innovative Packaging Technology

Thermal management is critical in high power LED applications. With a low thermal resistance from junction SFT-10 LEDs can be driven at higher current densities while maintaining a low junction temperature, thereby resulting in brighter solutions and longer lifetimes.

Reliability

SFT-10 has passed a rigorous suite of environmental and mechanical stress tests, including mechanical shock, vibration, temperature cycling and humidity, and have been fully qualified for use in high power / small form factor / high current applications pico applications.

With very low failure rates and median lifetimes that typically exceed 60,000 hours, Luminus SFT-Series LEDs are ready for even the most demanding applications. (Please refer to Luminus' Reliability application note for more information.)

Environmental Benefits

Luminus LEDs help reduce power consumption and the amount of hazardous waste entering the environment. All LED products manufactured by Luminus are RoHS and REACH compliant and free of hazardous materials, including lead and mercury.

Understanding SMT Test Specifications

Every Luminus LED is tested to ensure that it meets the high quality standards expected from Luminus' products.

Testing of SMT LEDs

The Luminus SFT series of products are measured in such a way that allows high volume / fast paced (single pulse) production but accurate measurement that correlates with real world operating conditions.

Luminus makes available to its customers correlation curves (page 8) that allow one to predict with significant accuracy performance in typical "Display" applications.

Ordering Information (SMT Configuration)^{1,3}

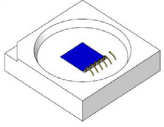
| Ordering Part Number ^{1,3} | Color | Min Flux Bin ² | Description | Configuration |
|-------------------------------------|-----------|---------------------------|-----------------------------------------------------------------------------------------------------------------------------------------------------------------------------------------|-------------------------------------------------------------------------------------|
| SFT-10-RA-F35-MPA | Red Amber | 1A | Red-Amber LED consisting of a 1.0 mm ² die mounted on a small 3.5 x 3.5mm high-performance package with directional indicator. |  |
| SFT-10-CG-F35-MPC | | Converted Green | | |
| SFT-10-CG-F35-MPD | 2D | | Converted Green consisting of a 1.0 mm ² die Blue die mounted on a small 3.5 x 3.5mm high-performance package driving a Green Phosphor Platelet, with directional indicator. | |
| SFT-10-B-F35-EPC | Blue | 4C | Blue LED consisting of a 1.0 mm ² die mounted on a small 3.5 x 3.5mm high-performance package with directional indicator. | |
| SFT-10-B-F35-EPD | | 4D | | |

Ordering Information (Starboard Configuration)^{1,3,4}

| Ordering Part Number ^{1,3} | Color | Min Flux Bin ² | Description | Configuration |
|-------------------------------------|-----------|---------------------------|------------------------------------------------------------------------------------------------------------------------------------------------------------------------|--------------------------------------------------------------------------------------|
| SFT-10-RA-R35-MPA | Red Amber | 1A | Red-Amber LED consisting of a 1.0 mm ² die in a small 3.5 x 3.5mm package mounted on a thermally efficient and pedestal, common cathode designed starboard. |  |
| SFT-10-CG-R35-MPC | | Converted Green | | |
| SFT-10-CG-R35-MPD | 2D | | Converted Green LED consisting of a 1.0 mm ² die with Green Phosphor Platelet in a small 3.5 x 3.5mm package | |
| SFT-10-B-R35-EPC | Blue | 4C | Blue LED consisting of a 1.0 mm ² die in a small 3.5 x 3.5mm package mounted on a thermally efficient and pedestal, common cathode designed starboard. | |
| SFT-10-B-R35-EPD | | 4D | | |

Note 1: Ordering part numbers represent bin kits (group of bins that are shippable for a given ordering part number)

Note 2: See Bin Kit and Flux bin definitions on page 5.

Note 3: Bin Kits are defined by a group of flux or power bins. Only one flux / power bin will be shipped in each individual pack or reel. Each shipment will contain reels of different allowed bins for a specific orderable part number (See page 5)
Individual Flux or Power bins are not orderable

Note 4: Starboard Configuration are available for sample quantity only. For additional quantity, contact Luminus representative.

Ordering Part Number Nomenclature



SFT — nn — XXXX — XXX — XYZ

| Product Family | Chip Area | Color | Package Configuration | Bin Kit ¹ |
|---------------------------------------|-------------------------|-----------------------------------------------------|-----------------------------------------------------------------------------------------------------------------------------------|-----------------------------------|
| SFT: Small Flat-Top windowless format | 10: 1.0 mm ² | RA = Red - Amber CG = Converted Green B= Blue | F35: 3.5mm x 3.5mm See Mechanical Drawing section R35: SFT-10 mounted on Starboard Starboard only in sample quantity | See page 5 for bin kit definition |

Note: A Bin Kit represents a group of individual flux or power bins that are shippable for a given ordering part number. Individual flux bins are not orderable.

EXAMPLES: SFT-10-CG-F35-MPC is comprised of Converted Green Flux Bins 2C, 2D, 2E, and 2F,

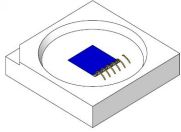
PACKAGE CONFIGURATIONS

| Package Configuration ¹ | Type | Picture | Description |
|------------------------------------|-----------|-----------------------------------------------------------------------------------|----------------------------------------------------------------------------------------------------------------------------------------------------------------------------------------------------------------------------------------------------------------------------------------------------------------------------------------------------------------------------------------------------------------------------------|
| F35 | SMT |  | Standard configuration A 1.0 mm ² die mounted on a small 3.5 x 3.5mm high-performance package with directional indicator. |
| R35 | STARBOARD |  | Pre-Mounted Configuration. The standard SFT-10 SMT Package pre-mounted on a Luminus thermally efficient and pedestal, common cathode designed copper 19.9 x 19.9mm starboard. See page 15. Starboard only in sample quantity. Contact Luminus representative for additional requirements. Starboard requires electrical isolation in most system designs. Starboard backside is connected to LED cathode. |

Note 1:

The packaging configuration must be specified within the orderable part number.
If not specified, or invalid, the order may be rejected or default to the "F35" (Standard) configuration.

Ordering Part Number Nomenclature

| SFT | nn | XXXX | XXX | XYZ |
|---------------------------------------|-------------------------|-----------------------------------------------------|-----------------------------------------------------------------------------------------------------------------------------------|-----------------------------------|
| Product Family | Chip Area | Color | Package Configuration ² | Bin Kit ¹ |
| SFT: Small Flat-Top windowless format | 10: 1.0 mm ² | RA = Red - Amber CG = Converted Green B= Blue | F35: 3.5mm x 3.5mm See Mechanical Drawing section R35: SFT-10 mounted on Starboard Starboard only in sample quantity | See page 5 for bin kit definition |

Note 1: A Bin Kit represents a group of individual flux or power bins that are shippable for a given ordering part number. Individual flux bins are not orderable.
EXAMPLES: SFT-10-CG-F35-MPC is comprised of Converted Green Flux Bins 2C, 2D, 2E, and 2F,

Note 2: Starboard only in sample quantity. Contact Luminus representative for additional requirements.

SFT-10 Bin Kit¹ and Flux Bin^{3,4} Definitions

Note: Please refer to ordering part number table on page 3 for Bin Kit availability

| | | | | | | | | | | | |
|-----------------------------------------------|---------|-------------|-------------|-------------|-------------|-------------|-------------|-------------|-------------|--|--|
| Red -Amber Flux Bins | Bin 1Z | Bin 1A | Bin 1B | Bin 1C | Bin 1D | Bin 1E | Bin 1F | Bin 1G | Bin 1H | | |
| Red -Amber Bin Flux Range (lm) | 80 - 90 | 90 - 100 | 100 - 110 | 110 - 120 | 120 - 130 | 130 - 145 | 145 - 155 | 155 - 170 | 170 - 185 | | |
| SFT-10-RA-F35-MPA | | ☑ | ☑ | ☑ | ☑ | ☑ | | | | | |
| Conv Green Flux Bins | | Bin 2A | Bin 2B | Bin 2C | Bin 2D | Bin 2E | Bin 2F | Bin 2G | Bin 2H | | |
| Conv Green Bin Flux Range (lm) | | 200 - 215 | 215 - 240 | 240 - 260 | 260 - 285 | 285 - 305 | 305 - 325 | 325 - 350 | 350 - 380 | | |
| SFT-10-CG-F35-MPC | | | | ☑ | ☑ | ☑ | ☑ | | | | |
| SFT-10-CG-F35-MPD | | | | | ☑ | ☑ | ☑ | ☑ | | | |
| Blue Power Bins | | Bin 4A | Bin 4B | Bin 4C | Bin 4D | Bin 4E | Bin 4F | Bin 4G | Bin 4H | | |
| Blue Optical Power Range (W/mm ²) | | 0.65 - 0.70 | 0.70 - 0.75 | 0.75 - 0.85 | 0.85 - 0.95 | 0.95 - 1.05 | 1.05 - 1.15 | 1.15 - 1.25 | 1.25 - 1.35 | | |
| SFT-10-B-F35-EPC | | | | ☑ | ☑ | ☑ | ☑ | | | | |
| SFT-10-B-F35-EPD | | | | | ☑ | ☑ | ☑ | ☑ | | | |

Wavelength Dominant Bin² Definitions

| Color | Bin | Minimum WLD (nm) | Maximum WLD (nm) |
|-----------|-----|------------------|------------------|
| Red-Amber | R1 | 609 | 615 |
| Red-Amber | R2 | 615 | 621 |
| Blue | B1 | 449 | 455 |
| Blue | B2 | 455 | 460 |

Note 1: Bin Kits are defined by a group of flux or power bins. Only one flux / power bin will be shipped in each individual pack or reel. Each shipment will contain reels of different allowed bins for a specific orderable part number. Individual Flux or Power bins are not orderable.

Note 2: Wavelength bins are not orderable. Wavelength bins are displayed in product label.

Note 3: Packaging configuration must be specified in purchase order. Otherwise, order will either be rejected or default to the "F35" (Standard) configuration. For "StarBoard" configuration, "R35" should be used as package configuration code. Refer to Ordering Part Number Nomenclature on Page 4.

Note 4: SFT-10 LEDs are tested according to the process outlined on page 6. Devices are sorted and packed by flux bin. Not all flux bins are populated. Contact your local LDI representative for current production population.

Note 5: Luminus maintains a test measurement accuracy for LED flux and power of +/- 6%.

STANDARD TEST CONDITION

All performance metrics of the SFT-Series of LED's are characterized from a single current "PULSE"^{1,2,3}

The pulse duration is 20ms, and the applied current is 0.7A.

Rise and Fall times of the signal are negligible.

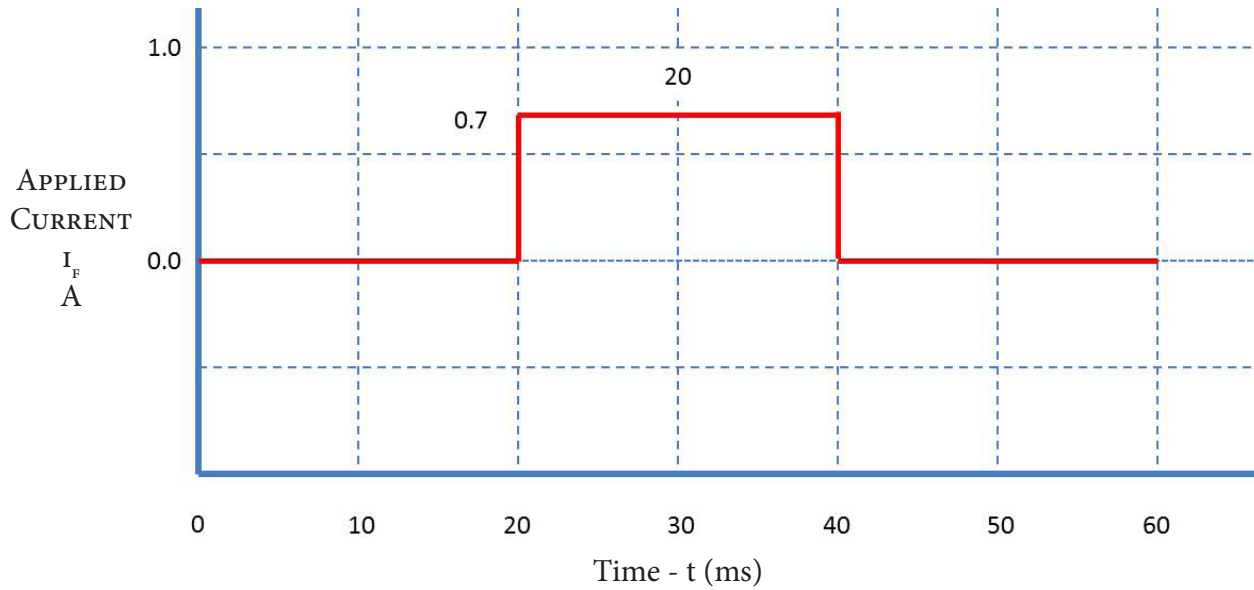

Note 1: Environmental temperature is assumed to be Ambient. (25C typ)

Note 2: Due to the brief nature of this test, T_j (Junction Temperature) is assumed to be ambient or approx 25C.

Note 3: Luminus maintains a tolerance of +/- 6% on flux measurements

Optical & Electrical Characteristics

| General Characteristics | | Symbol | Red -Amber | Converted Green | Blue* | Unit |
|---------------------------------------------------------------------------------------------------------------------------------|-----|------------------|------------|-----------------|-----------|-----------------|
| Emitting Area | | | 1.0 | 1.0 | 1.0 | mm ² |
| Emitting Area Dimensions | | | 1.0 x 1.0 | 1.0 x 1.0 | 1.0 x 1.0 | mm x mm |
| Performance at Standard Test Conditions (See definition on p5) | | | | | | |
| Peak Luminous Flux ^{1,2,5} | typ | Φ_v | 120 | 259 | 34 | lm |
| Peak Radiometric Flux ^{1,2} | typ | Φ_r | 0.42 | 0.55 | 0.88 | W |
| Dominant Wavelength | min | λ_{dmin} | 609 | 545 | 449 | nm |
| | typ | λ_d | 613 | 555 | 455 | |
| | max | λ_{dmax} | 621 | 565 | 461 | |
| FWHM- Spectral bandwidth at 50% of Φ_v | typ | | 16 | 98 | 19 | |
| Chromaticity Coordinates ^{6,7} | typ | x | 0.66 | 0.33 | 0.14 | CIE x |
| | typ | y | 0.32 | 0.56 | 0.04 | CIE y |
| Forward Voltage | min | V_{Fmin} | 2.2 | 2.5 | 2.5 | V |
| | typ | V_F | 2.5 | 3.0 | 3.0 | |
| | max | V_{Fmax} | 3.0 | 3.6 | 3.6 | |
| Correlated Performance in Typical Display Application (2.5A/mm ² @ 40C) [Reference Only]. See curves starting on p8. | | | | | | |
| Reference Drive Current | typ | I_F | 2.5 | 2.5 | 2.5 | A |
| Reference Duty Cycle | typ | | 25 | 50 | 25 | % |
| Luminous Flux | typ | Φ_v | 300 | 650 | 100 | lm |
| Radiometric Flux | typ | Φ_r | 1.1 | 1.4 | 2.0 | W |
| Dominant Wavelength | typ | λ_d | 613 | 555 | 453 | nm |
| FWHM -Spectral bandwidth at 50% of Φ_v | typ | | 15 | 99 | 19 | |
| Chromaticity Coordinates ^{6,7} | typ | x | 0.66 | 0.32 | 0.14 | |
| | typ | y | 0.33 | 0.55 | 0.04 | |
| Forward Voltage | typ | V_F | 3.6 | 3.5 | 3.4 | V |

Note 1: All ratings are based on standard testing conditions unless specified otherwise.

Note 2: Parameters rated at Standard Test condition as defined on page 6.

Note 3: Duty Cycle used to specify device ratings under Pulsed operation. SFT-Series of LEDs can operate at duty cycles ranging from 1% to 100%. At higher duty cycles, drive current should be adjusted to maintain the junction temperature at desired levels to meet the application lifetime requirements.

Note 4: In pulsed operation, rise time from 10 to 90% of forward current should be larger than 0.5 microseconds.

Note 6: CIE 1931 chromaticity diagram coordinates, normalized to X+Y+Z=1.

Note 7: For Reference only.

Optical & Electrical Characteristics

Absolute Maximum Ratings

| | Symbol | Red - Amber | Converted Green | Blue | Unit |
|------------------------------------------------------------------------------------------------|------------|---------------------------------------------|-----------------|------------|------|
| Absolute Minimum Current (CW or Pulsed) ¹ | | 200 | 200 | 200 | mA |
| Absolute Maximum Current (CW) ² | | 2.5 | 3.0 | 3.0 | A |
| Absolute Maximum Reverse Drive Current (CW or Pulsed) | | 0, REVERSE CURRENT OPERATION IS NOT ALLOWED | | | |
| Absolute Maximum Current (Pulsed) ^{2,3} (Frequency > 240 Hz, duty cycle <70%) | | 3.0 | 4.0 | 4.0 | |
| Absolute Maximum Surge Current ^{2,3} (Frequency > 240 Hz, duty cycle =10%, t= 1ms) | | 4.0 | 4.0 | 4.0 | |
| Absolute Maximum Junction Temperature ⁴ | T_{jmax} | 110 | 150 | 150 | °C |
| Storage Temperature Range | | -40 / +100 | -40 / +100 | -40 / +100 | |

- Note 1: Product performance and lifetime data is specified at recommended forward drive currents. Sustained operation at or near absolute minimum currents may result in a reduction of device performance and device lifetime compared to recommended forward drive currents.
- Note 2: Sustained operation above maximum currents is not recommended and will result in a reduction of device lifetime compared to specified maximum forward drive currents. Device lifetimes will depend on junction temperature. (See Reliability Application Note, APN-001444 for product lifetimes as function of junction temperature.) Please refer to lifetime de-rating curves (available from Luminus) for further information.
- Note 3: In pulsed operation, rise time from 10 to 90% of forward current should be larger than 0.5 microseconds.
- Note 4: Sustained operation at Absolute Maximum Operating Junction Temperature (T_{jmax}) will result in reduced device life time.

Normalized Luminous Flux

vs. Forward Current ($T_{hs} = 25^{\circ}\text{C}$, $I_f = \text{Pulse}$)

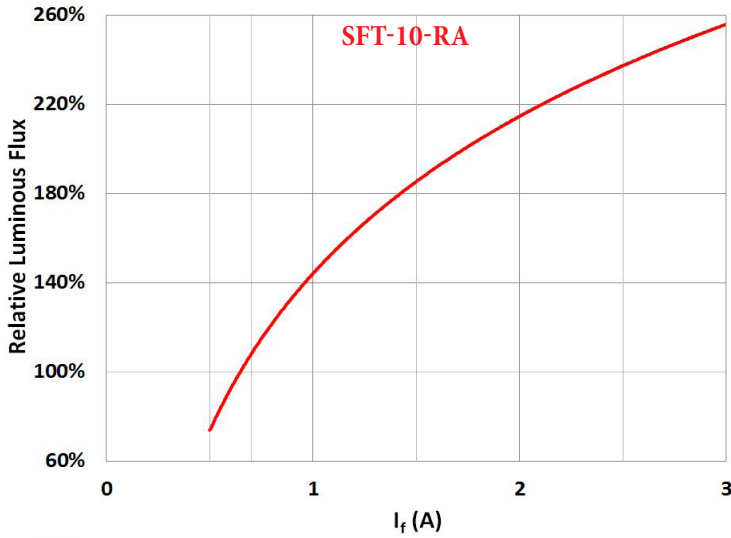

vs. T_j ($I_f = 0.7\text{A}$ Pulse)

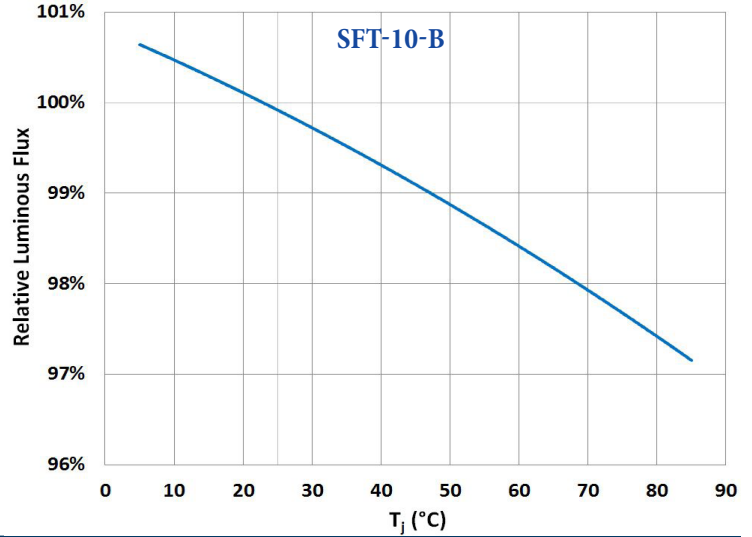
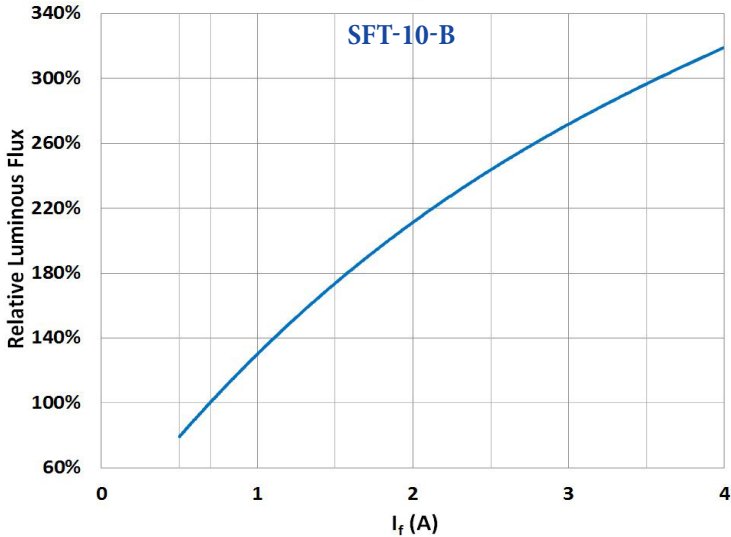
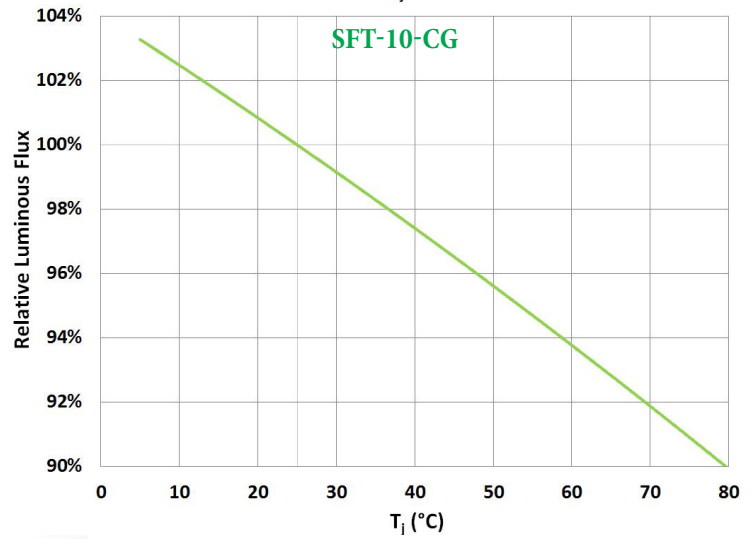
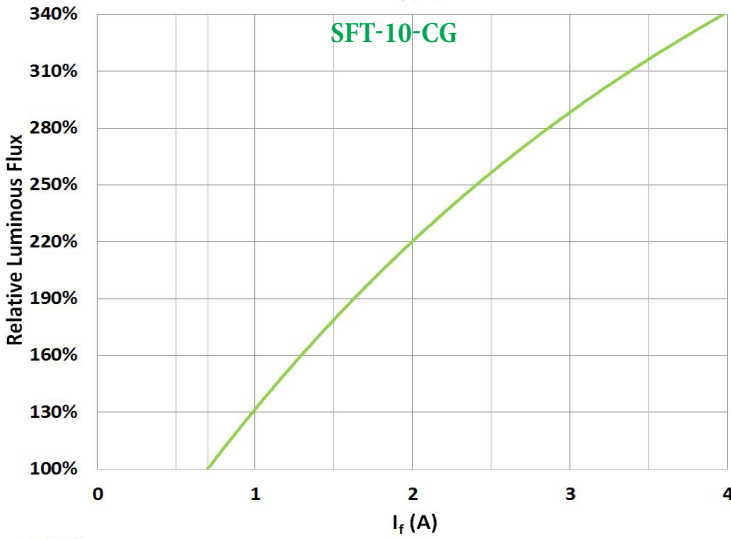
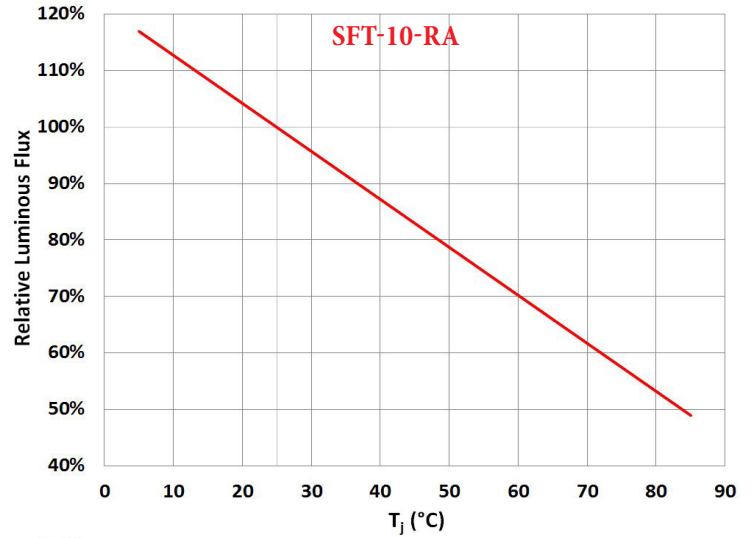

Relative Forward Voltage

vs. Forward Current ($T_{hs} = 25^{\circ}\text{C}$, $I_f = \text{Pulse}$)

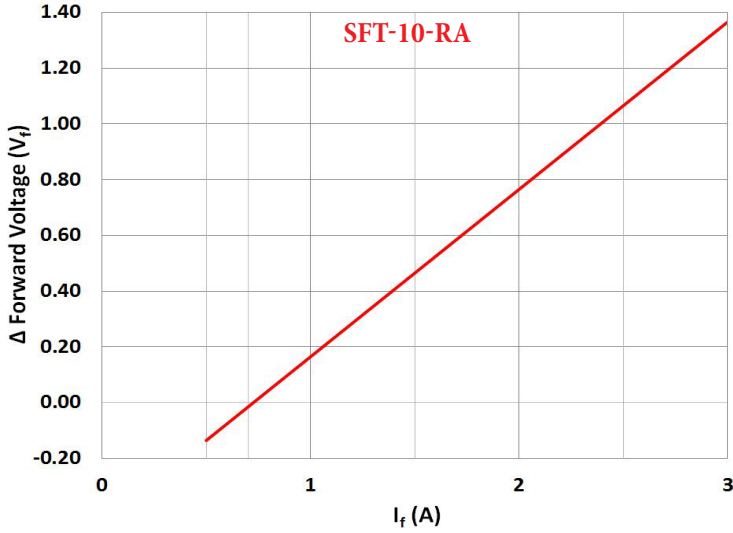

vs. T_j ($I_f = 0.7\text{A Pulse}$)

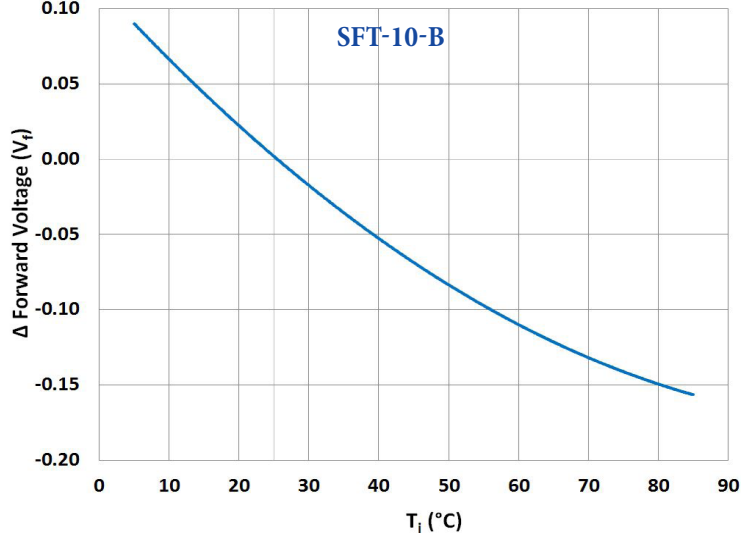
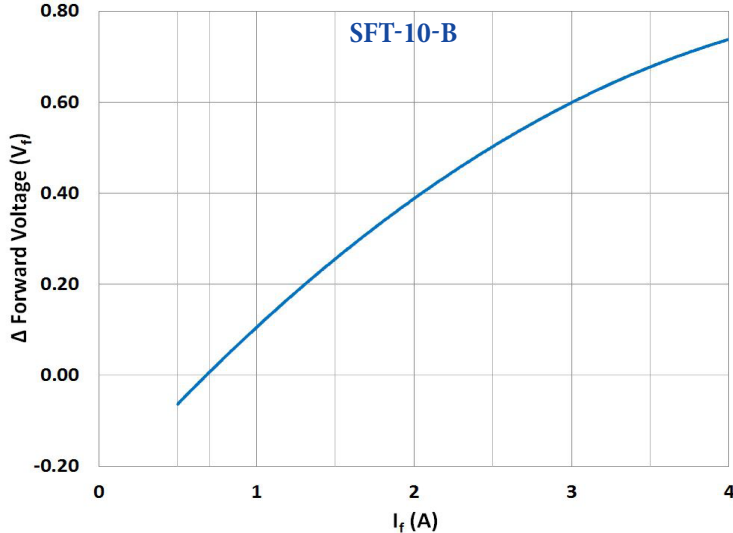
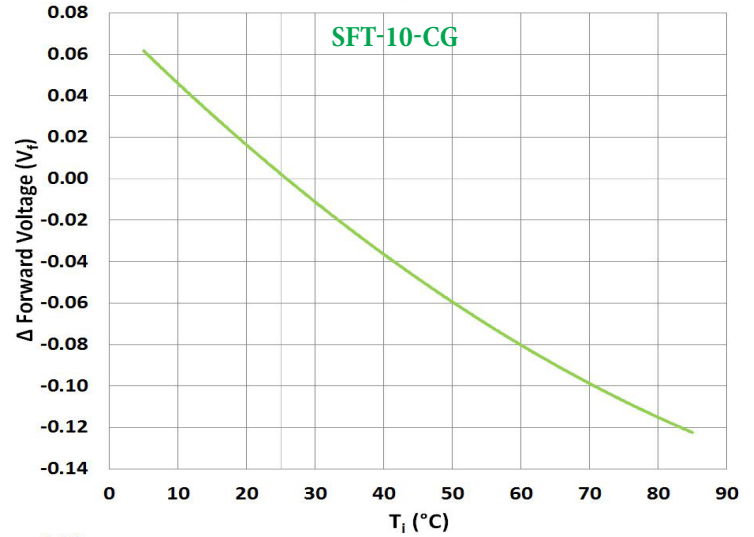
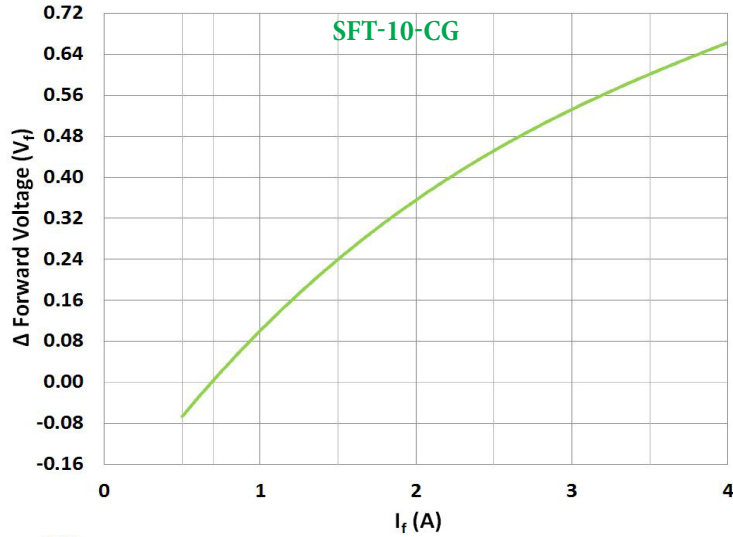
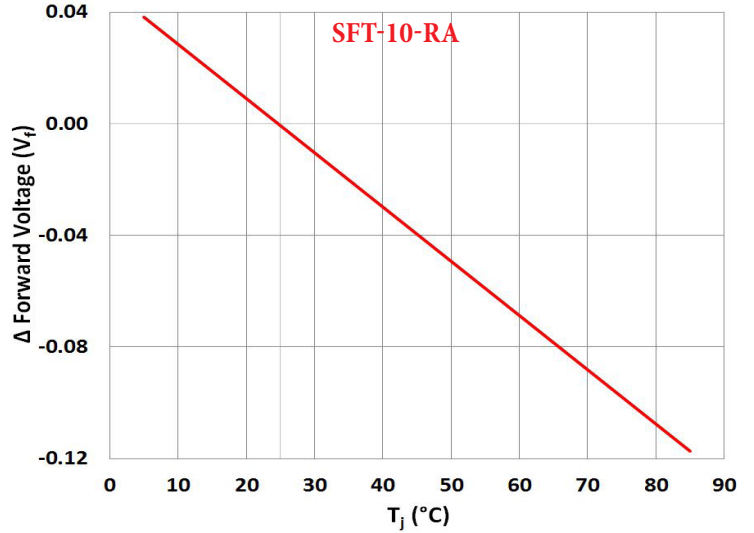

RELATIVE DOMINANT WAVELENGTH

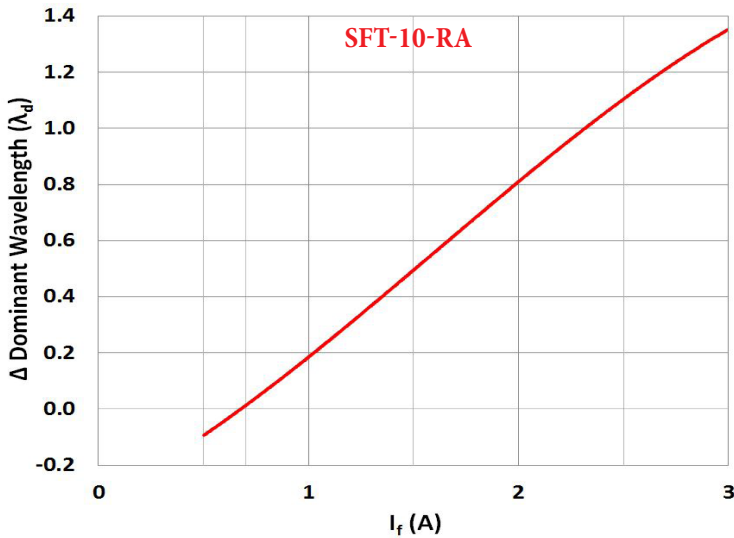
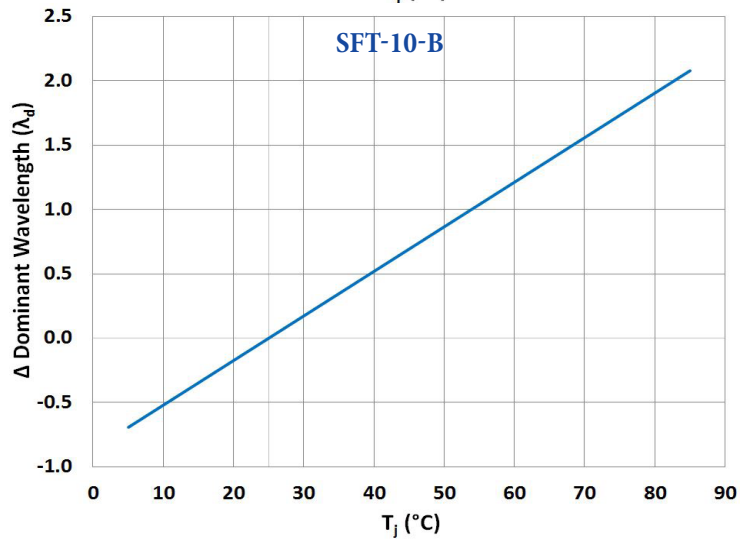
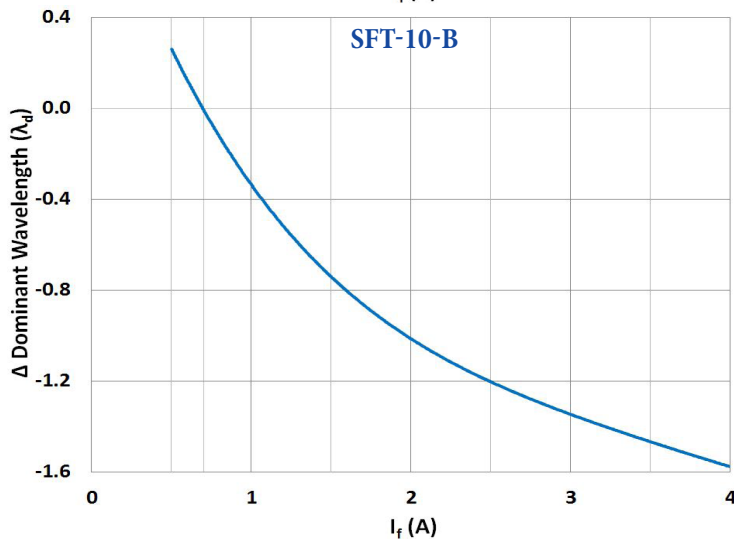
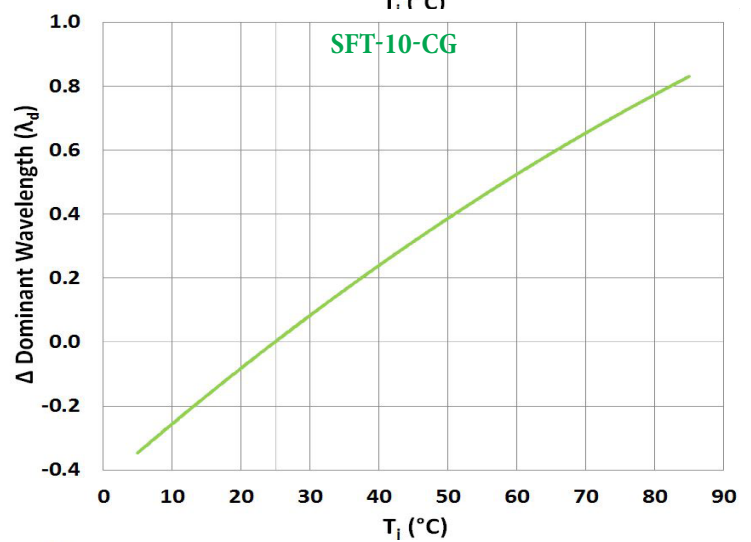
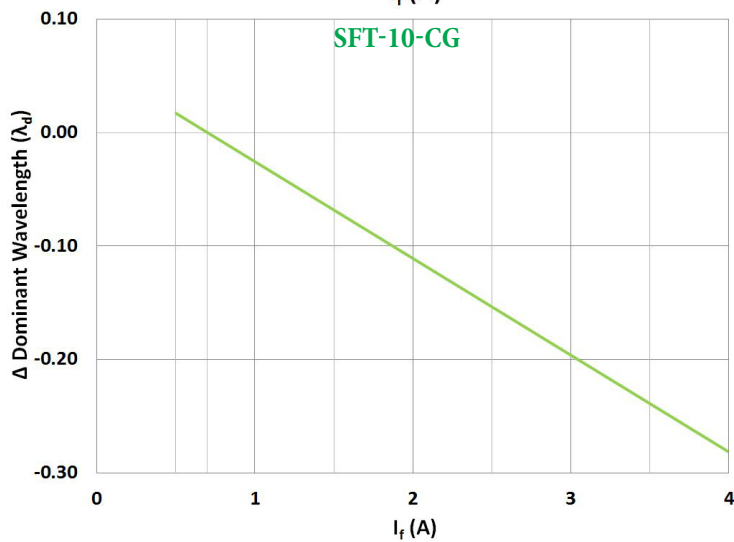
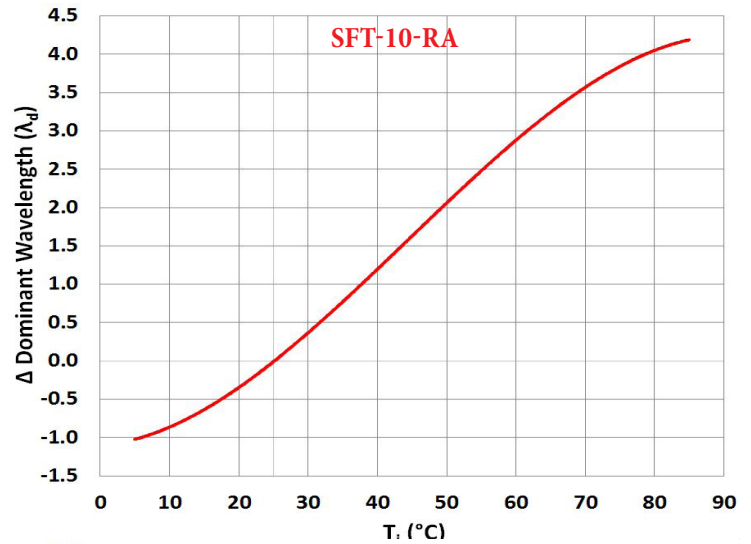
vs. Forward Current ($T_{hs} = 25^\circ\text{C}$, $I_f = \text{Pulse}$)

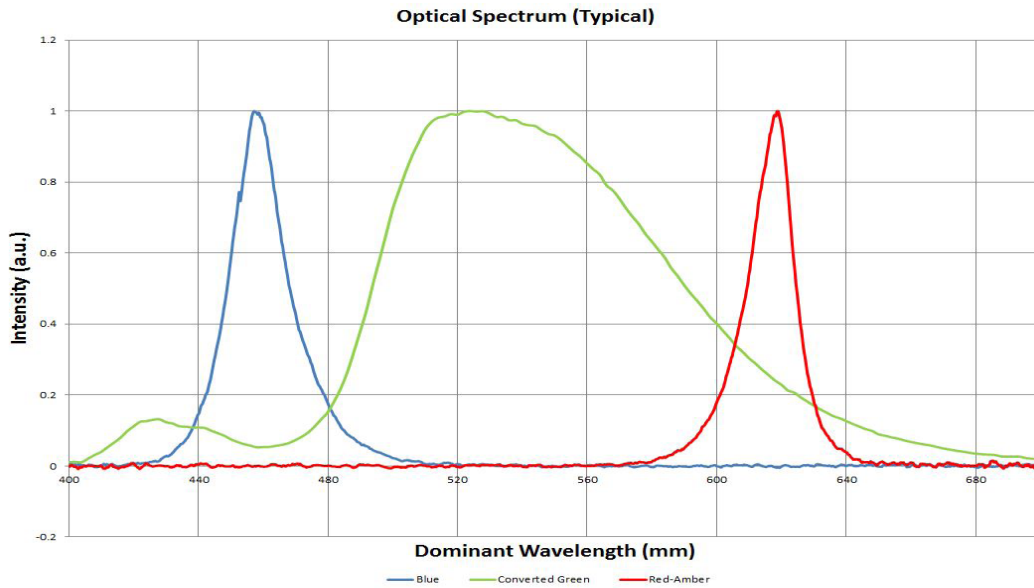
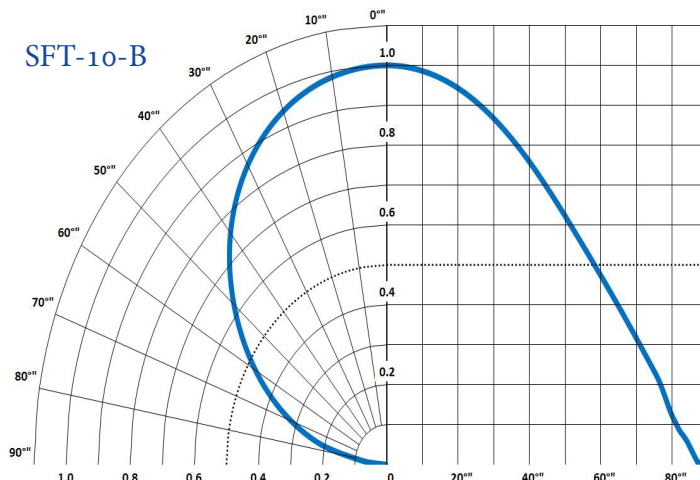
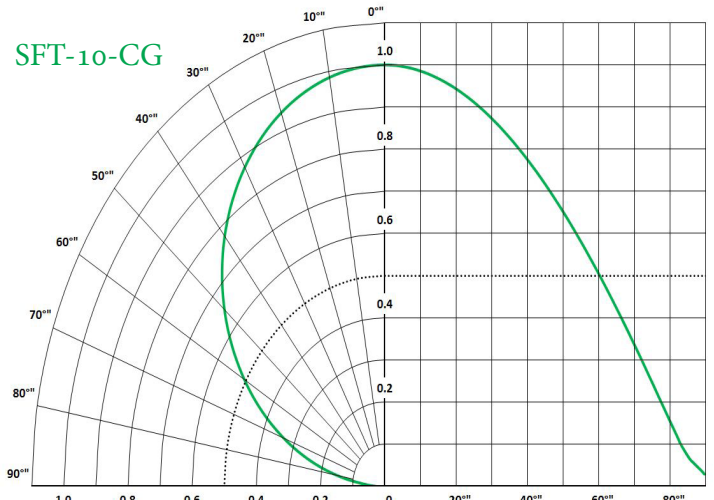
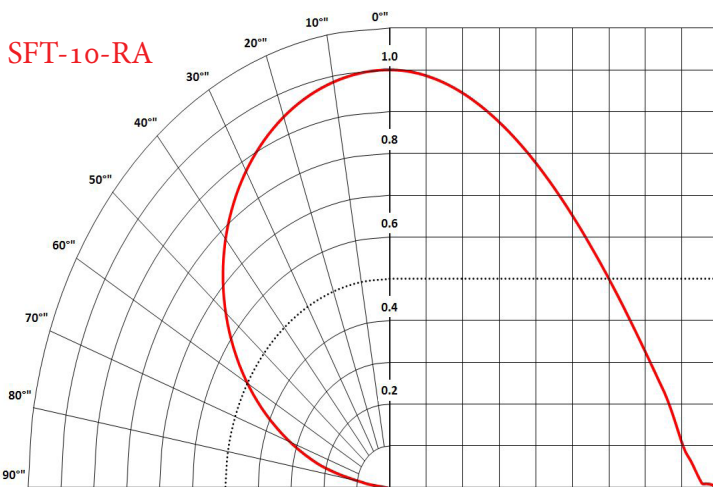
vs. T_j ($I_f = 0.7\text{A}$ Pulse)

SFT-Series Optical Spectrum (Typical) ¹

Angular Intensity Distribution (Typical) ¹

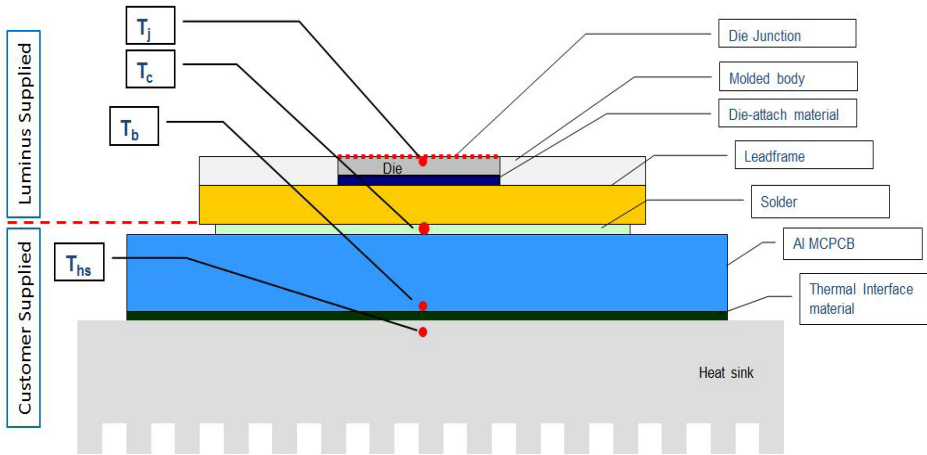
Note 1: Data is recorded using standard test conditions and tolerances as described on page 6.

Thermal Resistance



Typical Thermal Resistance

| | |
|-----------------|----------|
| $R_{J-C}^{1,2}$ | 3.0° C/W |
|-----------------|----------|

Note 1: Thermal resistance values are based on FEA model results correlated to measured $R_{th-j-hs}$ data.

Note 2: System Thermal Characteristics will be dependent on customer-side thermal strategy.

Note 3: For optimal results, Luminus recommends customer PCB Design in accordance with suggestion provided by the Luminus application note, "Design Guidelines for SFT Chipset Assembly".

Electrical Pinout / Solder Pad Layout

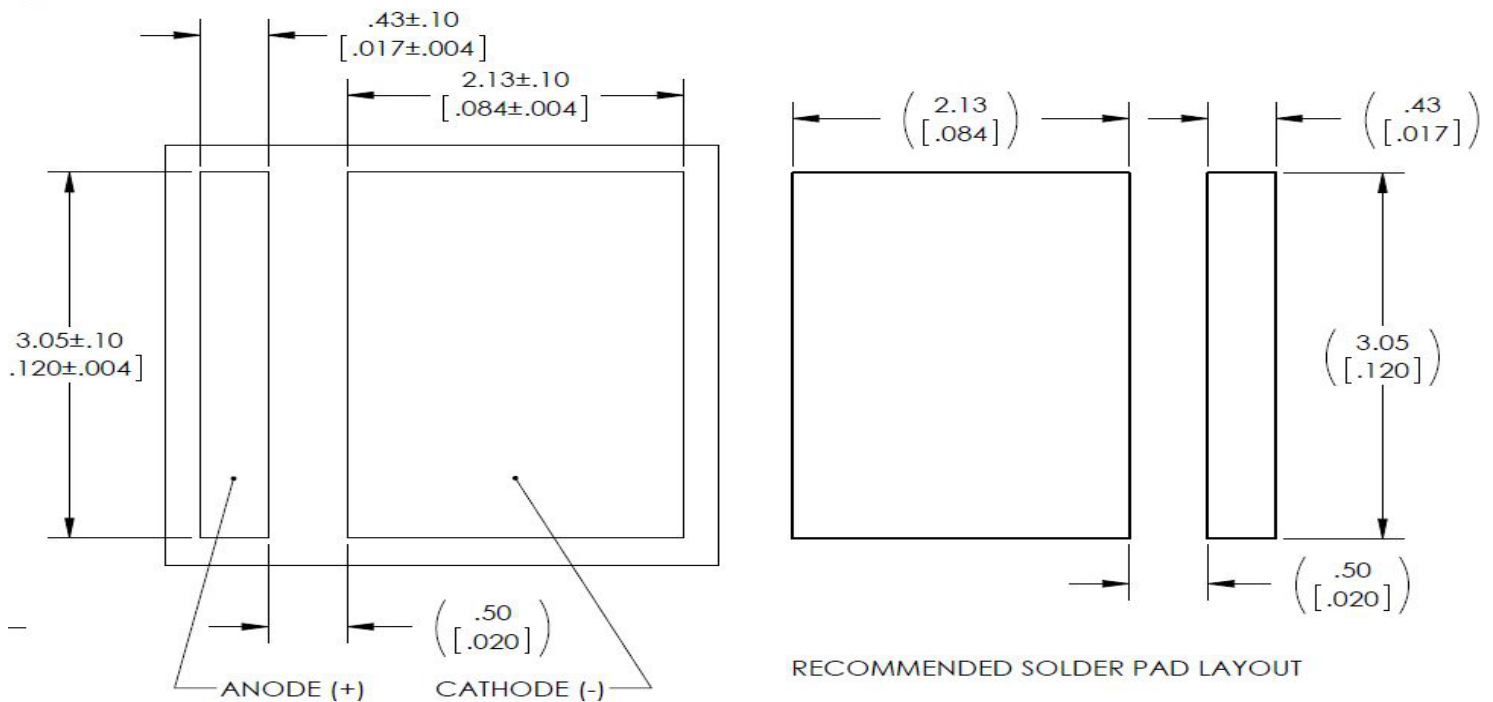

Note: Layout is common to all colors.
For recommended solder profiles, see page 16

Optimal LED performance is dependent on a proper system design. Please review the Luminus application note, "Design Guidelines for SFT Chipset Assembly." Contact Luminus for more detail.

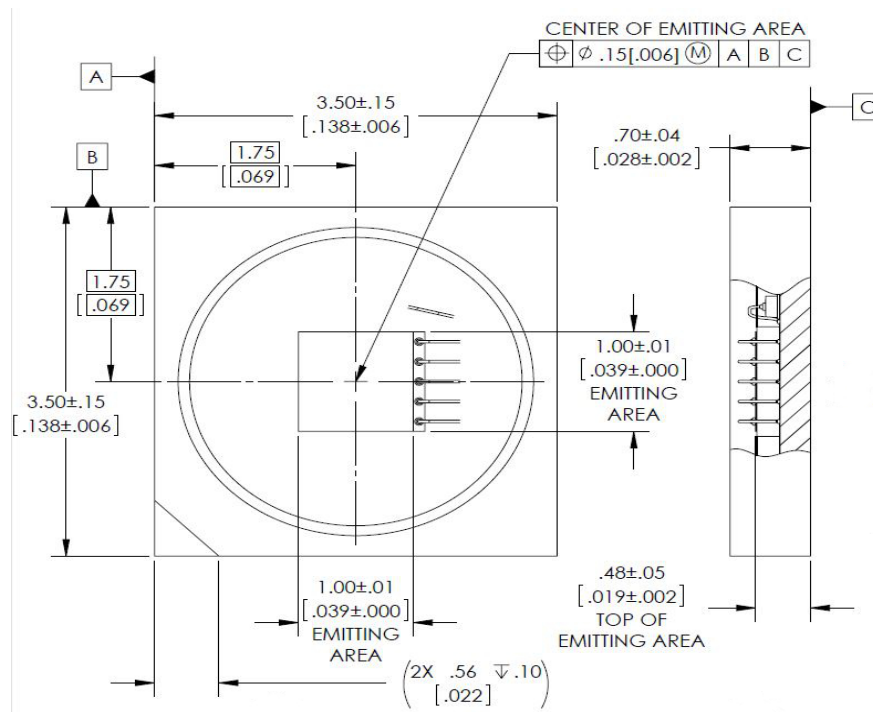
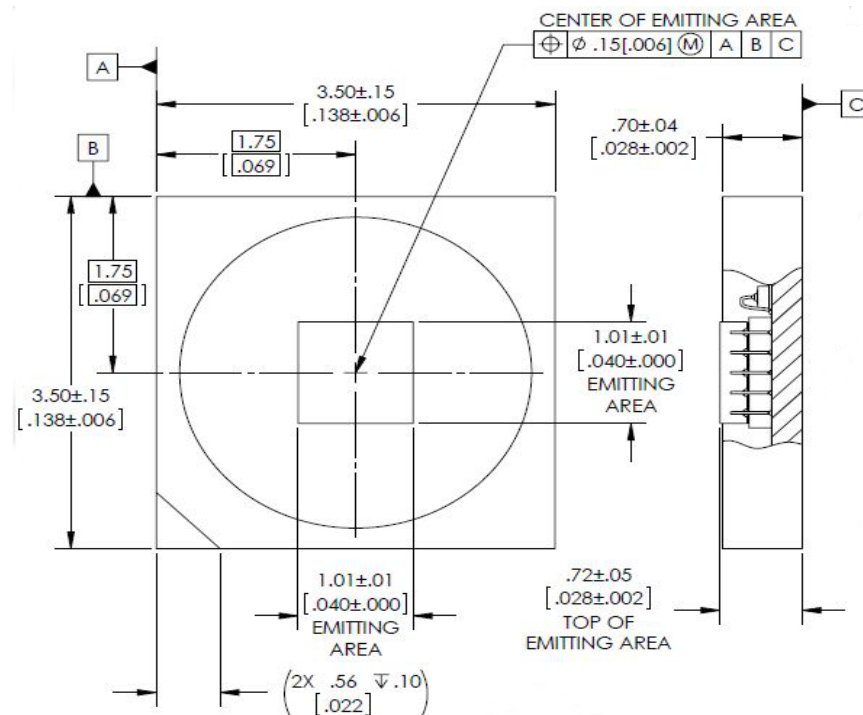
Mechanical Dimensions - SFT-10 [Red / Blue]

Mechanical Dimensions - SFT-10 [Converted Green]

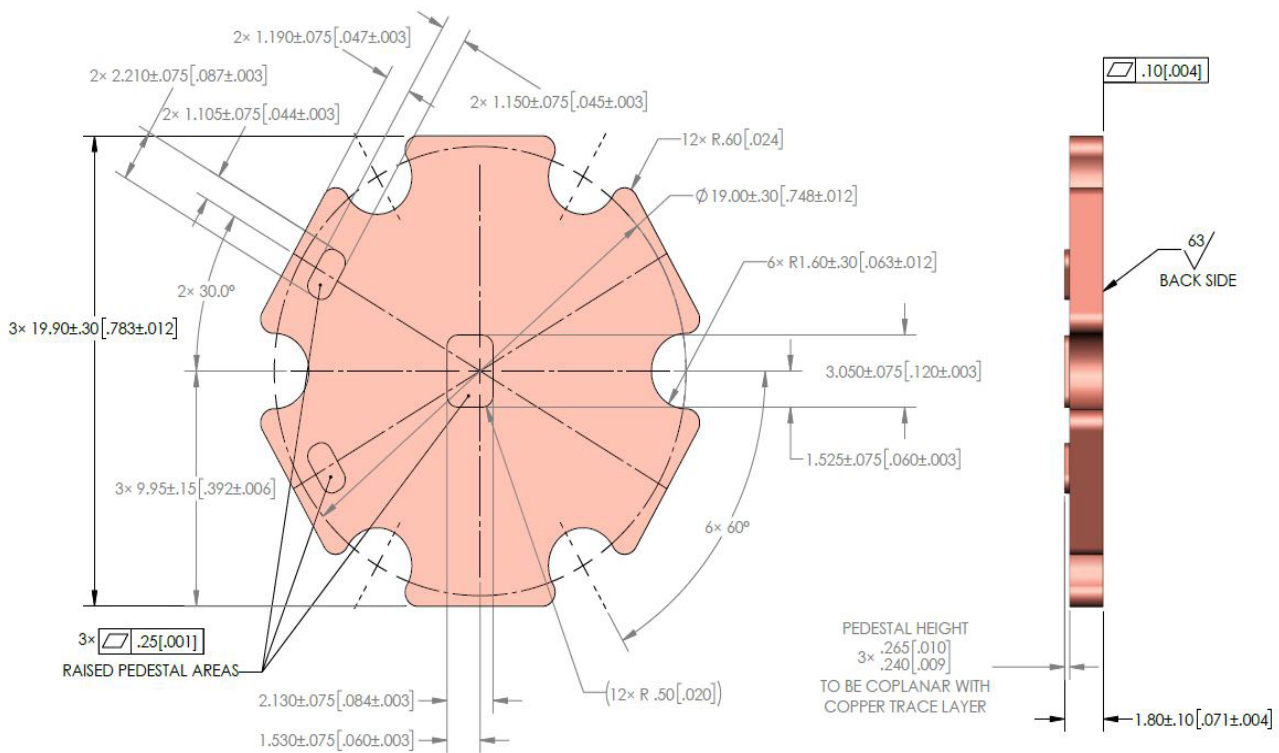
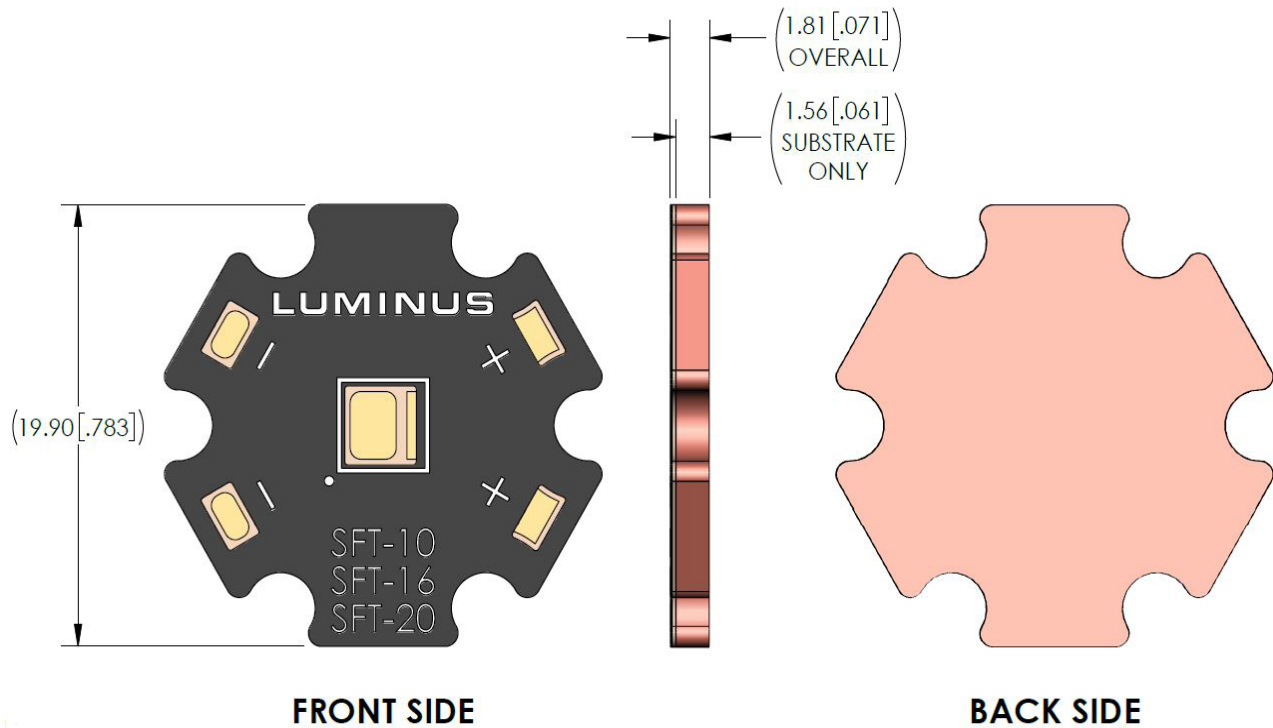
Notes: Converted Green differs from RED/BLUE in only the emitting surface is slightly larger than the underlying die.

Mechanical Dimensions - "Starboard" Package Configuration

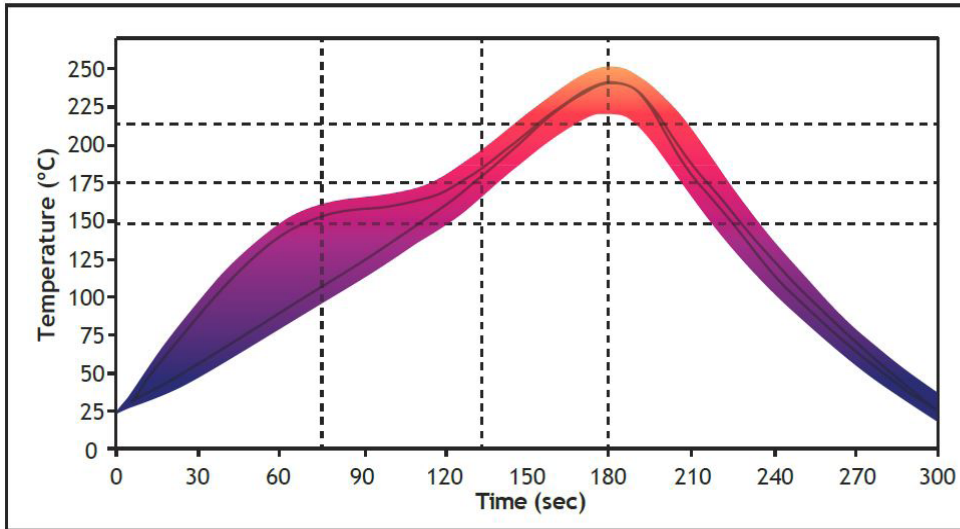
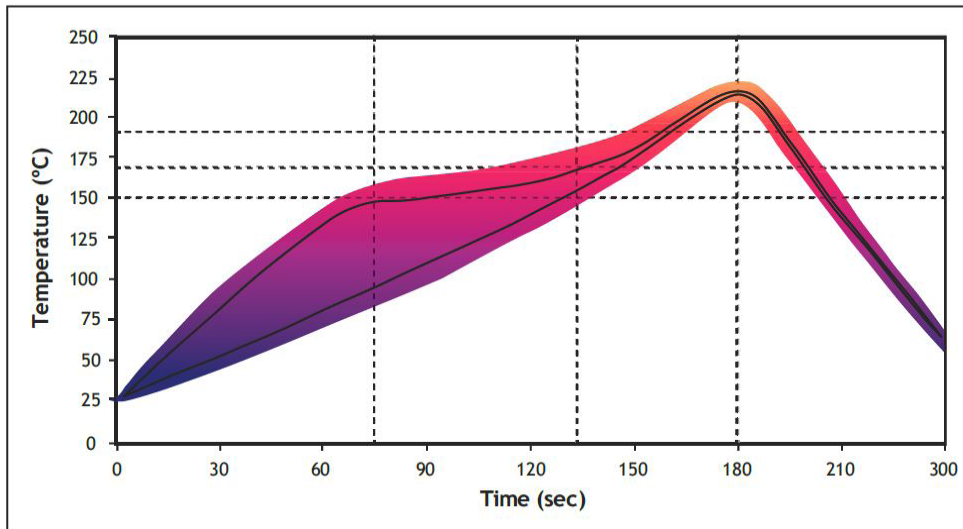
Notes:
 Dimensions shown are of bare Starboard. For full detail, please see DWG 400845 available from your local Luminus representative or web site.
 This Starboard is not electrically isolated. It is active and connected to the LED cathode.
 Starboard requires electrical isolation in most customer designs. Please see application note APN

SOLDER PROFILE INFORMATION

SAC305 Solder Profile Graph

Sn63 & Sn62 Solder Profile Graph

| SAC 305 and Sn63 & Sn62 Solder Profile | | | |
|----------------------------------------|---------|-------------|-----------------------------------|
| Feature | SAC 305 | Sn63 & Sn62 | Unit |
| Ramp Up Rate Ambient to Preheat (min) | 1.15 | 1 | Degrees Celsius Per Second (°C/s) |
| Preheat Temperature | 175 | 150 | Degrees Celsius (°C) |
| Profile Length (Preheat to Peak) | 165-210 | 165-210 | Seconds (s) |
| Ramp Up Rate Preheat to Peak (min) | 1.5 | 0.84 | Degrees Celsius Per Second (°C/s) |
| Liquid Temperature | 217 | 183 | Degrees Celsius (°C) |
| Peak Temperature | 235 | 225 | Degrees Celsius (°C) |
| Time Above Liquid Temperature | 30-60 | 30-60 | Seconds (s) |
| Time Within 5C of Peak | 20 | 10 | Seconds (s) |
| Cool down Rate | <4 | <4 | Degrees Celsius Per Second (°C/s) |
| Cool Down Duration | 30-60 | 30-60 | Seconds (s) |
| 25 C to peak Temperature | 180 | 180 | Seconds (s) |

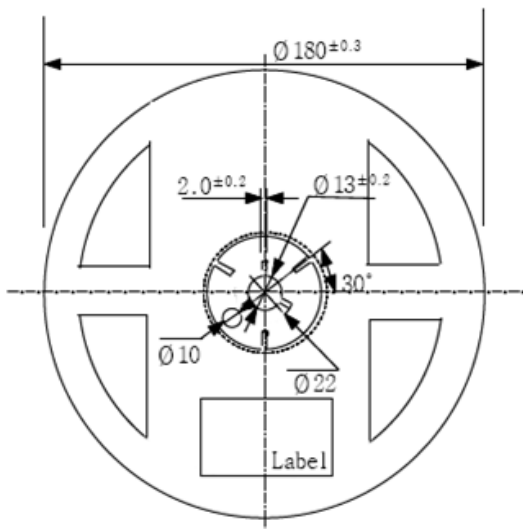
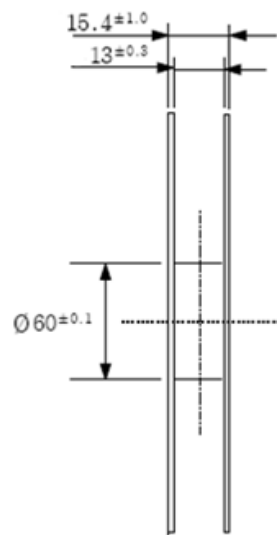
SHIPPING / PACKAGING INFORMATION

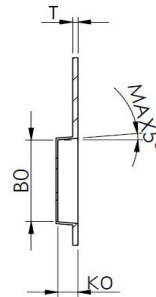
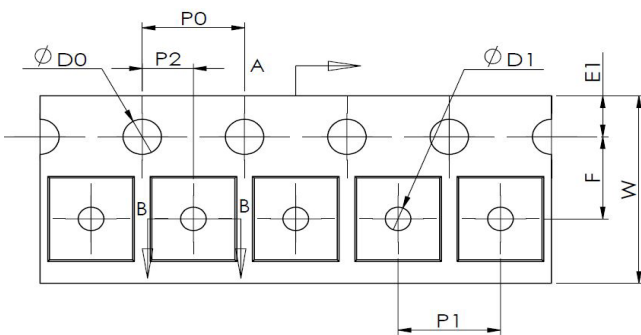
| ITEM | REEL | Box | |
|-----------|----------------|---------------------------------------|------------------|
| | | PACKING SPEC | BOX DIMENSION |
| PACKAGING | 250 PCS / REEL | 5 REELS PER BOX = 1250 PCS PER BOX | 225 X 245 X 65MM |

REEL DIAGRAM

TAPE DIMENSIONING DIAGRAM AND TABLE

BOX DIAGRAM

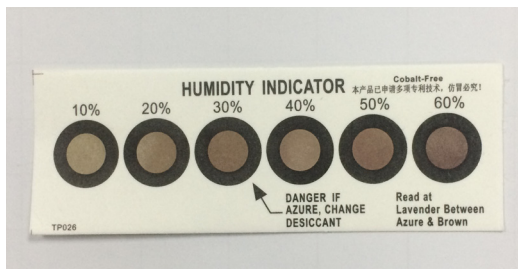
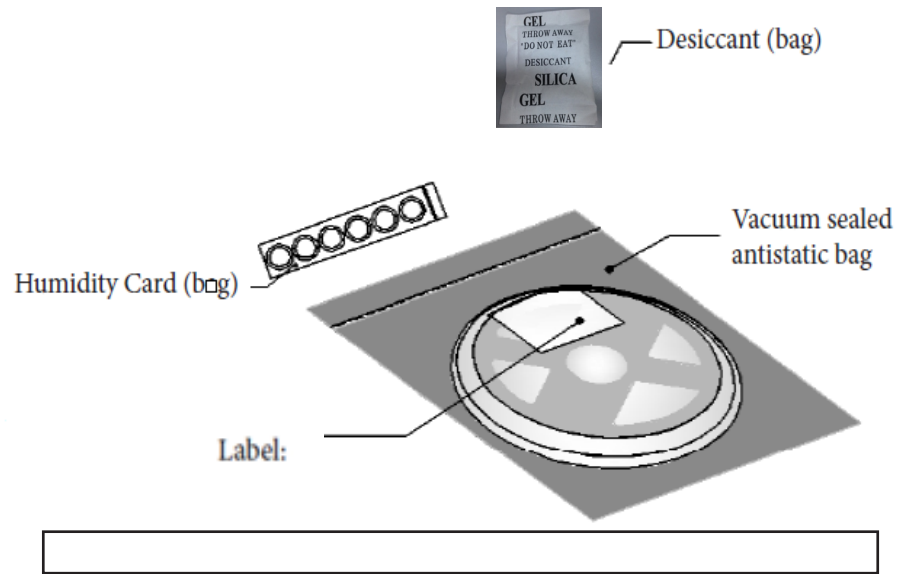
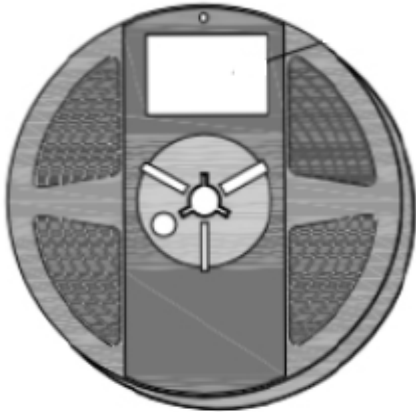
| DIMENSION | SPEC (MM) |
|-----------|----------------|
| AO | 3.80 +/- 0.10 |
| Bo | 4.00 +/- 0.10 |
| Ko | 1.20 +/- 0.10 |
| PO | 4.00 +/- 0.10 |
| P1 | 8.00 +/- 0.10 |
| P2 | 2.00 +/- 0.05 |
| T | 0.30 +/- 0.05 |
| E1 | 1.75 +/- 0.10 |
| F | 5.50 +/- 0.05 |
| Do | 1.55 +/- 0.05 |
| D1 | 1.55 +/- 0.05 |
| W | 12.00 +/- 0.01 |

REEL PACKAGING

HUMIDITY CARD

THE HUMIDITY INDICATOR IS INCLUDED WITHIN EACH ANTI-STATIC BAG. IF HUMIDITY INDICATOR IS TRIGGERED REPLACE DESICCANT AND/OR PRE-BAKE PRIOR TO SYSTEM ASSEMBLY.

LDI RECOMMENDS ALL SFT-SERIES LED ARE STORED "SEALED" UNTIL TIME OF USE. SEE APPLICATION NOTE.

LABEL

CPN: SFT-10-B-F35

MPN: 113148

QTY: 250

Label Fields:

- **CPN:** Customer orderable Part Number (as defined on P3)
- **MPN:** Manufacturer Part Number (Internal Luminus use)
- **QTY:** Quantity of Devices
- **Bin/Flux:** Flux Bin
- **Bin/Voltage:** Vf Bin (Internal Luminus use)
- **Bin/Color:** Color or Wavelength
- **MFG INFO:** Luminus Internal Use

| BIN INFO | |
|----------|----|
| Flux: | 4A |
| Voltage: | V1 |
| Color: | B |

| MFG INFO |
|-------------------|
| Rev: 01 |
| Lot#: TOR-1607034 |

RoHS Compliant

History of Changes

| Rev | | Description of Change |
|-----|------------|------------------------------------------------------------------------------------|
| 1 | 07/21/2017 | Release version Removed "Preliminary" Updated flux and wavelength bin tables |
| 2 | 11/22/2017 | Ordering information updated |

The products, their specifications and other information appearing in this document are subject to change by Luminus Devices without notice. Luminus Devices assumes no liability for errors that may appear in this document, and no liability otherwise arising from the application or use of the product or information contained herein. None of the information provided herein should be considered to be a representation of the fitness or suitability of the product for any particular application or as any other form of warranty. Luminus Devices' product warranties are limited to only such warranties as accompany a purchase contract or purchase order for such products. Nothing herein is to be construed as constituting an additional warranty. No information contained in this publication may be considered as a waiver by Luminus Devices of any intellectual property rights that Luminus Devices may have in such information.

This product is protected by U.S. Patents 6,831,302; 7,074,631; 7,083,993; 7,084,434; 7,098,589; 7,105,861; 7,138,666; 7,166,870; 7,166,871; 7,170,100; 7,196,354; 7,211,831; 7,262,550; 7,274,043; 7,301,271; 7,341,880; 7,344,903; 7,345,416; 7,348,603; 7,388,233; 7,391,059 Patents Pending in the U.S. and other countries.