

ON Semiconductor

Is Now

onsemi™

To learn more about onsemi™, please visit our website at
www.onsemi.com

onsemi and **onsemi** and other names, marks, and brands are registered and/or common law trademarks of Semiconductor Components Industries, LLC dba "**onsemi**" or its affiliates and/or subsidiaries in the United States and/or other countries. **onsemi** owns the rights to a number of patents, trademarks, copyrights, trade secrets, and other intellectual property. A listing of **onsemi** product/patent coverage may be accessed at www.onsemi.com/site/pdf/Patent-Marking.pdf. **onsemi** reserves the right to make changes at any time to any products or information herein, without notice. The information herein is provided "as-is" and **onsemi** makes no warranty, representation or guarantee regarding the accuracy of the information, product features, availability, functionality, or suitability of its products for any particular purpose, nor does **onsemi** assume any liability arising out of the application or use of any product or circuit, and specifically disclaims any and all liability, including without limitation special, consequential or incidental damages. Buyer is responsible for its products and applications using **onsemi** products, including compliance with all laws, regulations and safety requirements or standards, regardless of any support or applications information provided by **onsemi**. "Typical" parameters which may be provided in **onsemi** data sheets and/or specifications can and do vary in different applications and actual performance may vary over time. All operating parameters, including "Typicals" must be validated for each customer application by customer's technical experts. **onsemi** does not convey any license under any of its intellectual property rights nor the rights of others. **onsemi** products are not designed, intended, or authorized for use as a critical component in life support systems or any FDA Class 3 medical devices or medical devices with a same or similar classification in a foreign jurisdiction or any devices intended for implantation in the human body. Should Buyer purchase or use **onsemi** products for any such unintended or unauthorized application, Buyer shall indemnify and hold **onsemi** and its officers, employees, subsidiaries, affiliates, and distributors harmless against all claims, costs, damages, and expenses, and reasonable attorney fees arising out of, directly or indirectly, any claim of personal injury or death associated with such unintended or unauthorized use, even if such claim alleges that **onsemi** was negligent regarding the design or manufacture of the part. **onsemi** is an Equal Opportunity/Affirmative Action Employer. This literature is subject to all applicable copyright laws and is not for resale in any manner. Other names and brands may be claimed as the property of others.

ESD8451, SZESD8451

ESD Protection Diodes

Low Capacitance ESD Protection Diode for High Speed Data Line

The ESD8451 Series ESD protection diodes are designed to protect high speed data lines from ESD. Ultra-low capacitance and low ESD clamping voltage make this device an ideal solution for protecting voltage sensitive high speed data lines.

Features

- Low Capacitance (0.30 pF Max, I/O to GND)
- Protection for the Following IEC Standards:
IEC 61000-4-2 (Level 4)
ISO10605 330 pF / 2 kΩ ±30 kV Contact
- Low ESD Clamping Voltage
- SZ Prefix for Automotive and Other Applications Requiring Unique Site and Control Change Requirements; AEC-Q101 Qualified and PPAP Capable
- These Devices are Pb-Free, Halogen Free/BFR Free and are RoHS Compliant

Typical Applications

- USB 3.0
- MHL 2.0
- eSATA

MAXIMUM RATINGS (T_J = 25°C unless otherwise noted)

| Rating | Symbol | Value | Unit |
|--|------------------|-------------|------|
| Operating Junction Temperature Range | T _J | -55 to +125 | °C |
| Storage Temperature Range | T _{stg} | -55 to +150 | °C |
| Lead Solder Temperature – Maximum (10 Seconds) | T _L | 260 | °C |
| IEC 61000-4-2 Contact (ESD) | ESD | ±15 | kV |
| IEC 61000-4-2 Air (ESD) | ESD | ±15 | kV |

Stresses exceeding those listed in the Maximum Ratings table may damage the device. If any of these limits are exceeded, device functionality should not be assumed, damage may occur and reliability may be affected.

See Application Note AND8308/D for further description of survivability specs.



ON Semiconductor®

www.onsemi.com

MARKING DIAGRAMS

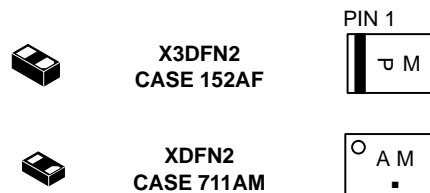

P, A = Specific Device Code
M = Date Code

PIN CONFIGURATION AND SCHEMATIC

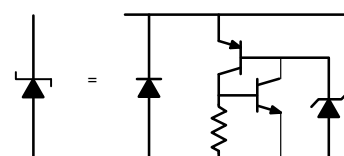

ORDERING INFORMATION

See detailed ordering and shipping information in the package dimensions section on page 8 of this data sheet.

ESD8451, SZESD8451

ELECTRICAL CHARACTERISTICS

(T_A = 25°C unless otherwise noted)

| Symbol | Parameter |
|-------------------|--|
| V _{RWM} | Working Peak Voltage |
| I _R | Maximum Reverse Leakage Current @ V _{RWM} |
| V _{BR} | Breakdown Voltage @ I _T |
| I _T | Test Current |
| V _{HOLD} | Holding Reverse Voltage |
| I _{HOLD} | Holding Reverse Current |
| R _{DYN} | Dynamic Resistance |
| I _{PP} | Maximum Peak Pulse Current |
| V _C | Clamping Voltage @ I _{PP} V _C = V _{HOLD} + (I _{PP} * R _{DYN}) |

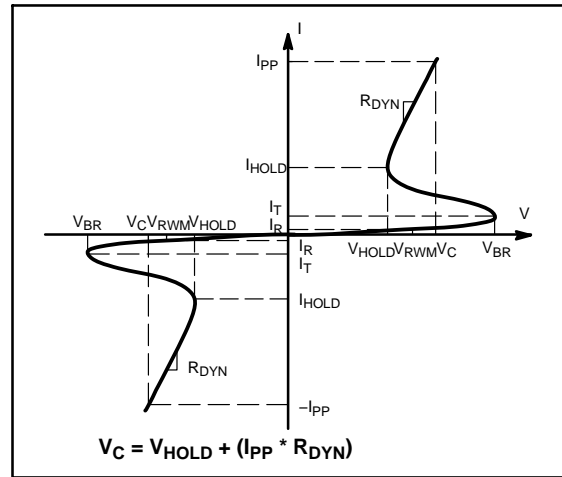

ELECTRICAL CHARACTERISTICS (T_A = 25°C unless otherwise specified)

| Parameter | Symbol | Conditions | Min | Typ | Max | Unit |
|--|-------------------|---|-----|--------------|------|------|
| Reverse Working Voltage | V _{RWM} | I/O Pin to GND | | | 3.3 | V |
| Breakdown Voltage | V _{BR} | I _T = 1 mA, I/O Pin to GND | 5.5 | 7.9 | 8.3 | V |
| Reverse Leakage Current | I _R | V _{RWM} = 3.3 V, I/O Pin to GND | | | 500 | nA |
| Reverse Holding Voltage | V _{HOLD} | I/O Pin to GND | | 2.05 | | V |
| Holding Reverse Current | I _{HOLD} | I/O Pin to GND | | 17 | | mA |
| Clamping Voltage (Note 1) | V _C | IEC61000-4-2, ±8 kV Contact | | | | V |
| ESD8451MUT5G Clamping Voltage | V _C | I _{PP} = 3.7 A, 8/20 μs pulse | | | 13.7 | V |
| ESD8451N2T5G Clamping Voltage | V _C | I _{PP} = 5.0 A, 8/20 μs pulse | | | 17.0 | V |
| ESD8451MUT5G Clamping Voltage TLP (Note 2) | V _C | I _{PP} = 8 A } IEC 61000-4-2 Level 2 equivalent (±4 kV Contact, ±4 kV Air) I _{PP} = 16 A } IEC 61000-4-2 Level 4 equivalent (±8 kV Contact, ±8 kV Air) | | 11.0 19.0 | | V |
| ESD8451N2T5G Clamping Voltage TLP (Note 2) | V _C | I _{PP} = 8 A } IEC 61000-4-2 Level 2 equivalent (±4 kV Contact, ±4 kV Air) I _{PP} = 16 A } IEC 61000-4-2 Level 4 equivalent (±8 kV Contact, ±8 kV Air) | | 9.0 16.0 | | V |
| ESD8451MUT5G Dynamic Resistance | R _{DYN} | Pin1 to Pin2 Pin2 to Pin1 | | 1.0 1.0 | | Ω |
| ESD8451N2T5G Dynamic Resistance | R _{DYN} | Pin1 to Pin2 Pin2 to Pin1 | | 0.84 0.84 | | Ω |
| Junction Capacitance | C _J | V _R = 0 V, f = 1 MHz | | 0.20 | 0.30 | pF |
| Junction Capacitance | C _J | V _R = 0 V, f = 2.5 GHz | | 0.19 | 0.25 | pF |

- For test procedure see Figure 16 and application note AND8307/D.
- ANSI/ESD STM5.5.1 – Electrostatic Discharge Sensitivity Testing using Transmission Line Pulse (TLP) Model.
TLP conditions: Z₀ = 50 Ω, t_p = 100 ns, t_r = 4 ns, averaging window; t₁ = 30 ns to t₂ = 60 ns.

ESD8451, SZESD8451

TYPICAL CHARACTERISTICS

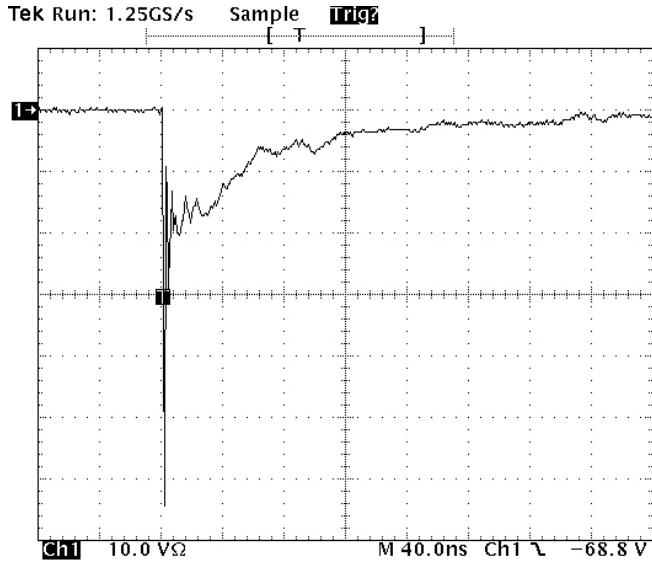

Figure 1. ESD8451N2 ESD Clamping Voltage Screenshot Negative 8kV Contact per IEC61000-4-2

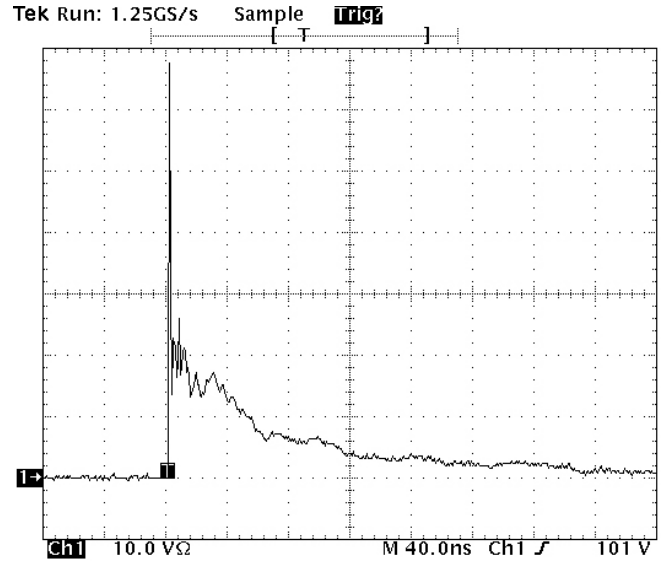

Figure 2. ESD8451N2 ESD Clamping Voltage Screenshot Positive 8kV Contact per IEC61000-4-2

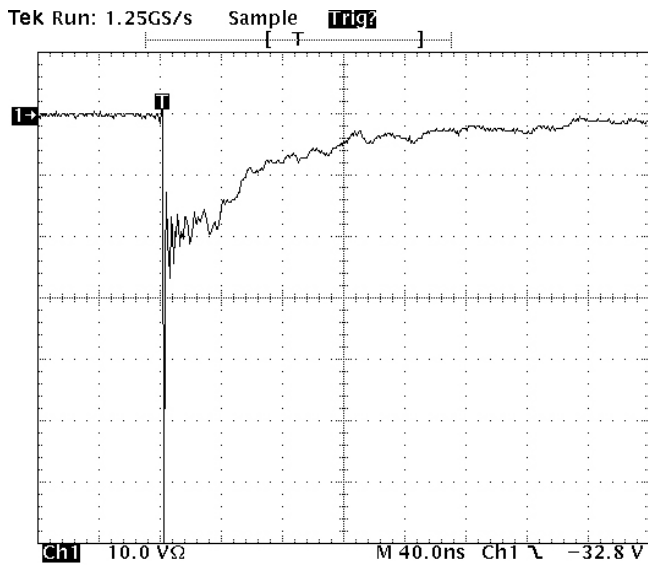

Figure 3. ESD8451MU ESD Clamping Voltage Screenshot Negative 8kV Contact per IEC61000-4-2

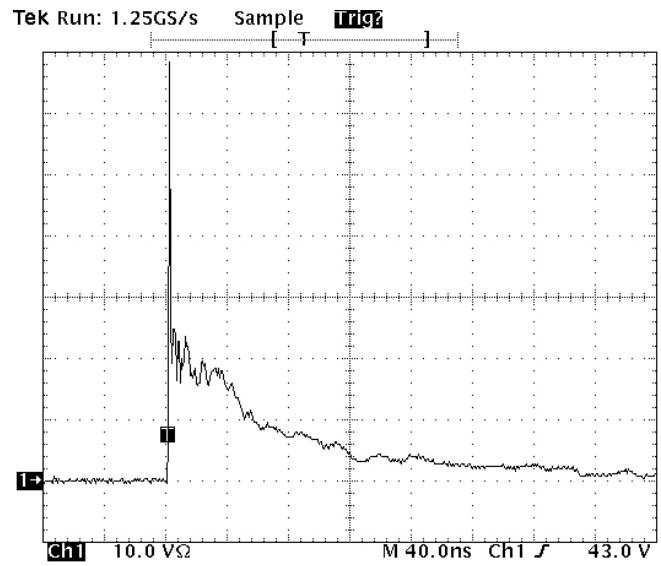

Figure 4. ESD8451MU ESD Clamping Voltage Screenshot Positive 8kV Contact per IEC61000-4-2

ESD8451, SZESD8451

TYPICAL CHARACTERISTICS

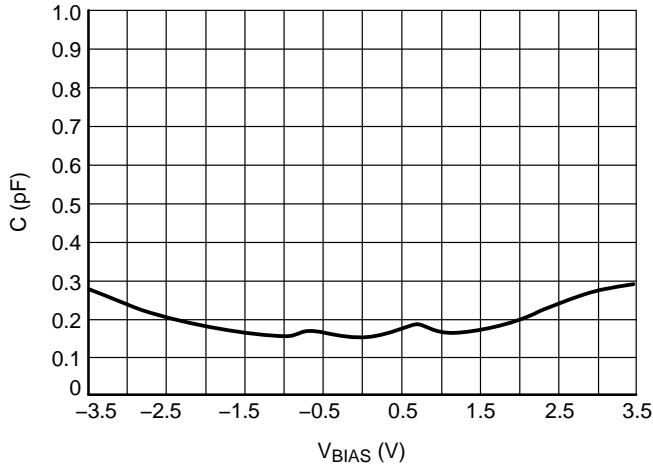

Figure 5. ESD8451MUT5G CV Characteristics

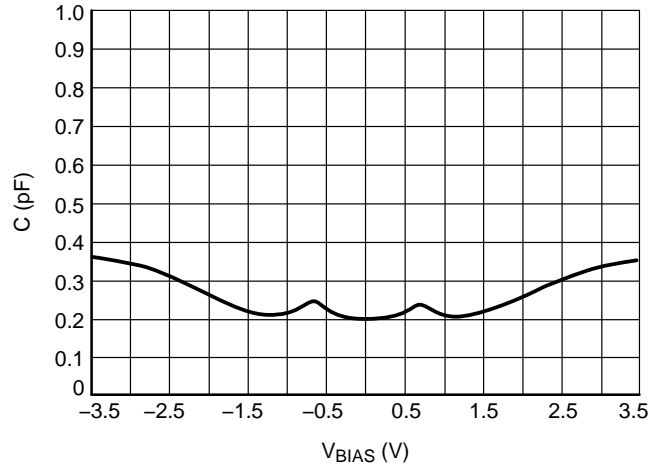

Figure 6. ESD8451N2T5G CV Characteristics

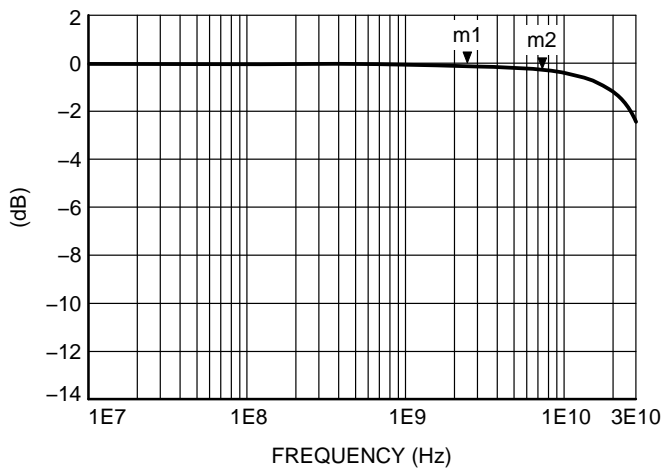

Figure 7. ESD8451MUT5G S21 Insertion Loss

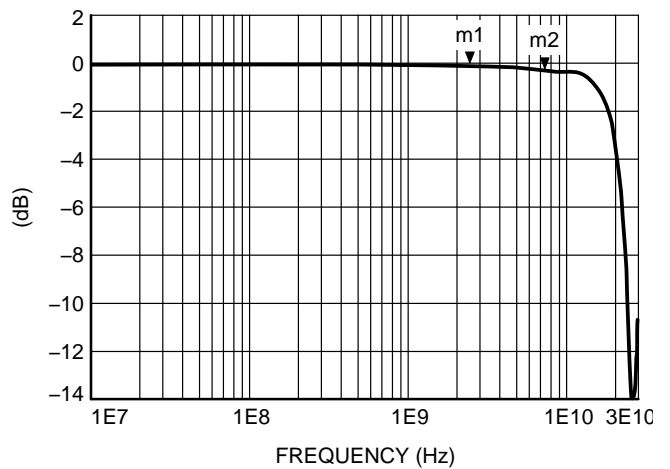

Figure 8. ESD8451N2T5G S21 Insertion Loss

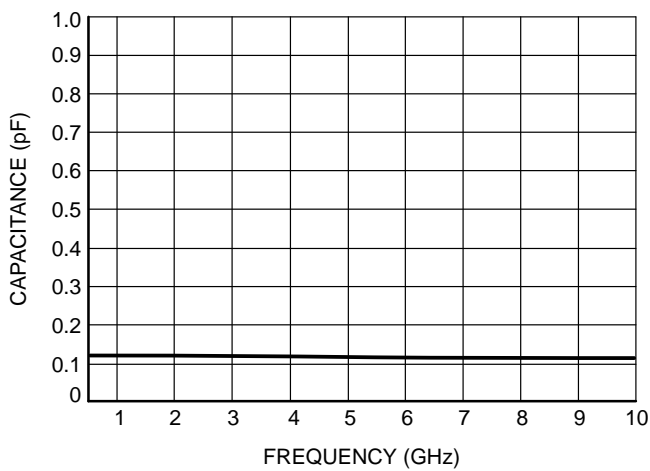

Figure 9. ESD8451MUT5G Capacitance over Frequency

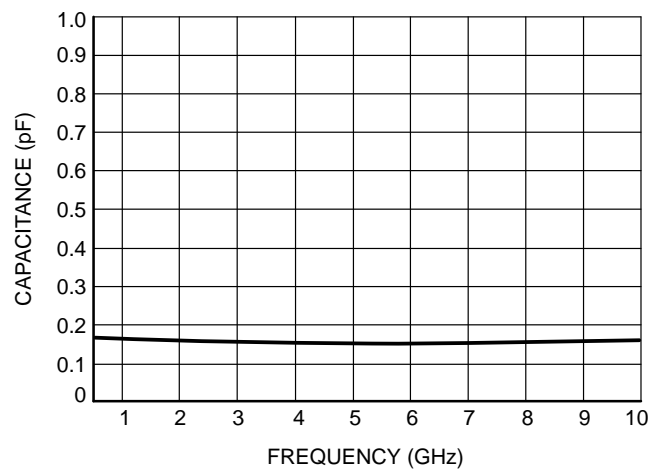

Figure 10. ESD8451N2T5G Capacitance over Frequency

ESD8451, SZESD8451

TYPICAL CHARACTERISTICS

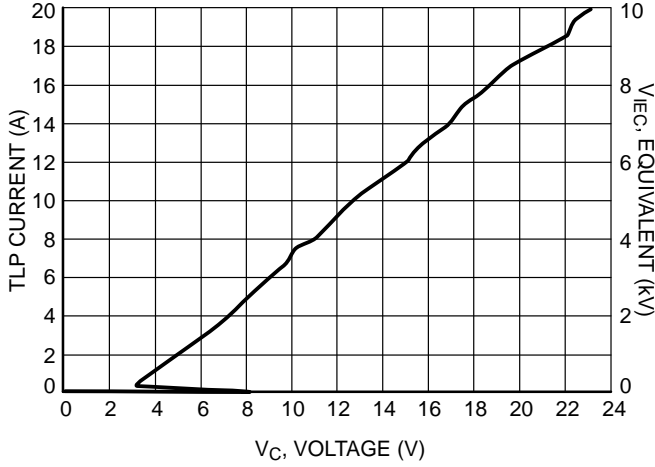

Figure 11. ESD8451MUT5G Positive TLP I-V Curve

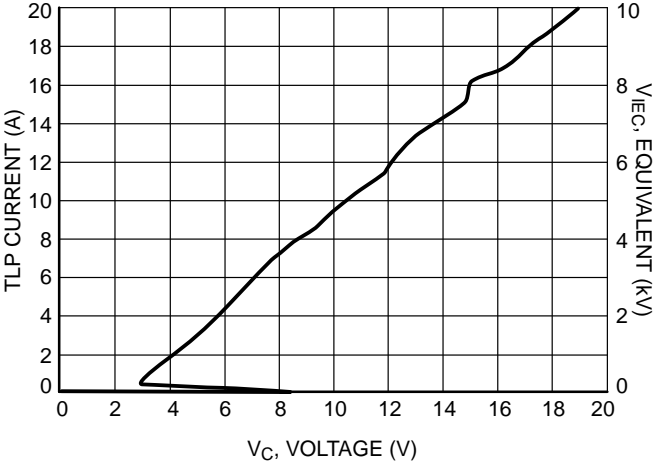

Figure 12. ESD8451N2T5G Positive TLP I-V Curve

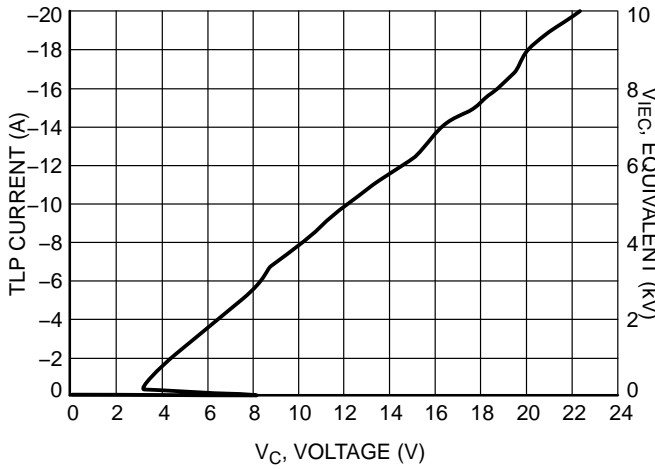

Figure 13. ESD8451MUT5G Negative TLP I-V Curve

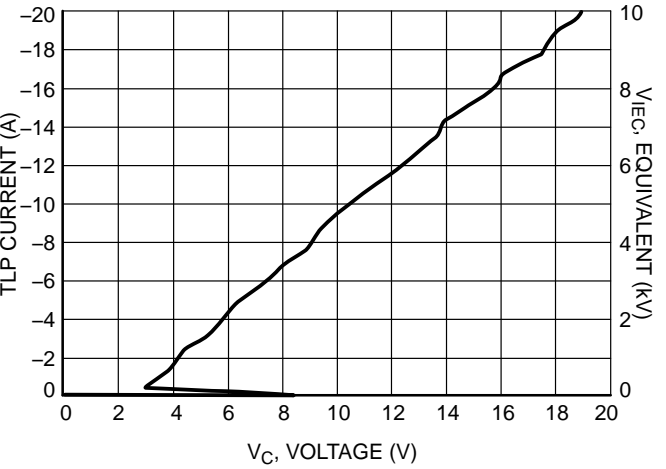

Figure 14. ESD8451N2T5G Negative TLP I-V Curve

ESD8451, SZESD8451

Latch-Up Considerations

ON Semiconductor's 8000 series of ESD protection devices utilize a snap-back, SCR type structure. By using this technology, the potential for a latch-up condition was taken into account by performing load line analyses of common high speed serial interfaces. Example load lines for latch-up free applications and applications with the potential for latch-up are shown below with a generic IV characteristic of a snapback, SCR type structured device overlaid on each. In the latch-up free load line case, the IV characteristic of the snapback protection device intersects the load-line in one unique point (V_{OP} , I_{OP}). This is the only

stable operating point of the circuit and the system is therefore latch-up free. In the non-latch up free load line case, the IV characteristic of the snapback protection device intersects the load-line in two points (V_{OPA} , I_{OPA}) and (V_{OPB} , I_{OPB}). Therefore in this case, the potential for latch-up exists if the system settles at (V_{OPB} , I_{OPB}) after a transient. Because of this, ESD8451 should not be used for HDMI applications – ESD8104 or ESD8040 have been designed to be acceptable for HDMI applications without latch-up. Please refer to Application Note AND9116/D for a more in-depth explanation of latch-up considerations using ESD8000 series devices.

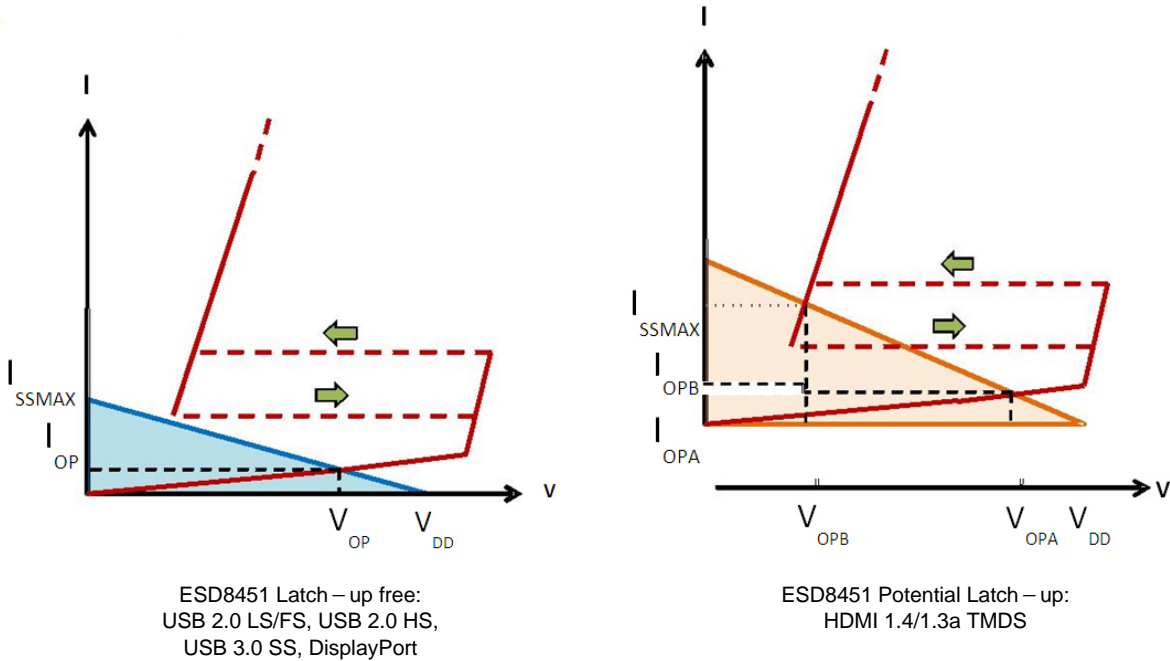

Figure 15. Example Load Lines for Latch-up Free Applications and Applications with the Potential for Latch-up

Table 1. SUMMARY OF SCR REQUIREMENTS FOR LATCH-UP FREE APPLICATIONS

| Application | VBR (min) (V) | IH (min) (mA) | VH (min) (V) | ON Semiconductor ESD8000 Series Recommended PN |
|--------------------|---------------|---------------|--------------|--|
| HDMI 1.4/1.3a TMDS | 3.465 | 54.78 | 1.0 | ESD8104, ESD8040 |
| USB 2.0 LS/FS | 3.301 | 1.76 | 1.0 | ESD8004, ESD8451 |
| USB 2.0 HS | 0.482 | N/A | 1.0 | ESD8004, ESD8451 |
| USB 3.0 SS | 2.800 | N/A | 1.0 | ESD8004, ESD8006, ESD8451 |
| DisplayPort | 3.600 | 25.00 | 1.0 | ESD8004, ESD8006, ESD8451 |

ESD8451, SZESD8451

IEC 61000-4-2 Spec.

| Level | Test Voltage (kV) | First Peak Current (A) | Current at 30 ns (A) | Current at 60 ns (A) |
|-------|-------------------|------------------------|----------------------|----------------------|
| 1 | 2 | 7.5 | 4 | 2 |
| 2 | 4 | 15 | 8 | 4 |
| 3 | 6 | 22.5 | 12 | 6 |
| 4 | 8 | 30 | 16 | 8 |

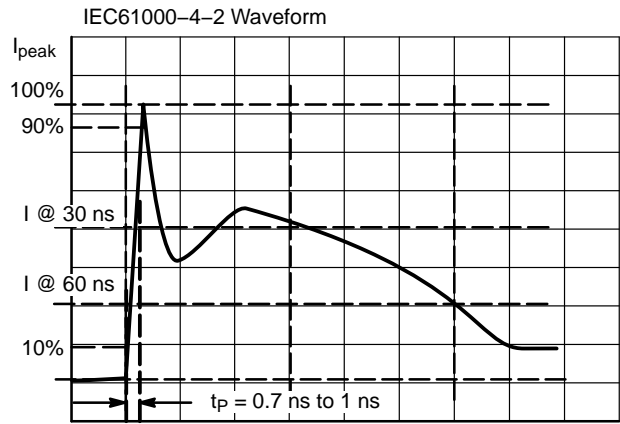

Figure 16. IEC61000-4-2 Spec

Transmission Line Pulse (TLP) Measurement

Transmission Line Pulse (TLP) provides current versus voltage (I-V) curves in which each data point is obtained from a 100 ns long rectangular pulse from a charged transmission line. A simplified schematic of a typical TLP system is shown in Figure 17. TLP I-V curves of ESD protection devices accurately demonstrate the product’s ESD capability because the 10s of amps current levels and under 100 ns time scale match those of an ESD event. This is illustrated in Figure 18 where an 8 kV IEC 61000-4-2 current waveform is compared with TLP current pulses at 8 A and 16 A. A TLP I-V curve shows the voltage at which the device turns on as well as how well the device clamps voltage over a range of current levels.

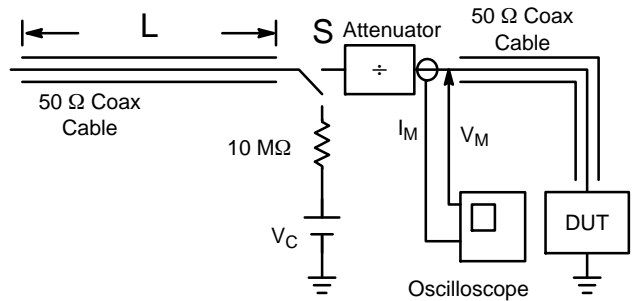

Figure 17. Simplified Schematic of a Typical TLP System

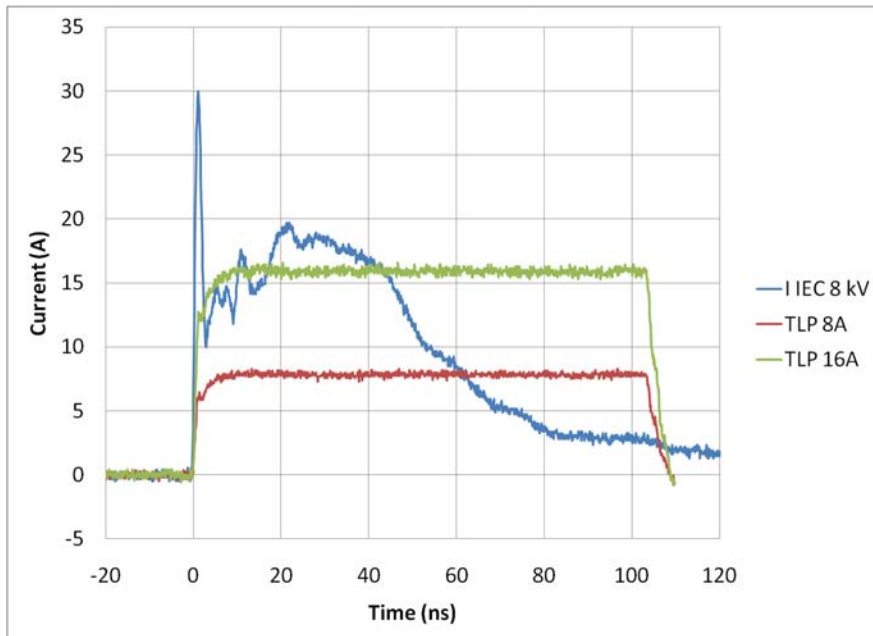

Figure 18. Comparison Between 8 kV IEC 61000-4-2 and 8 A and 16 A TLP Waveforms

ESD8451, SZESD8451

ORDERING INFORMATION

| Device | Package | Shipping† |
|----------------------------------|---------------------|---------------------|
| ESD8451N2T5G, SZESD8451N2T5G* | XDFN2 (Pb-Free) | 8000 / Tape & Reel |
| ESD8451MUT5G | X3DFN2 (Pb-Free) | 10000 / Tape & Reel |
| SZESD8451MUT5G* | X3DFN2 (Pb-Free) | 15000 / Tape & Reel |

†For information on tape and reel specifications, including part orientation and tape sizes, please refer to our Tape and Reel Packaging Specifications Brochure, BRD8011/D.

*SZ Prefix for Automotive and Other Applications Requiring Unique Site and Control Change Requirements; AEC-Q101 Qualified and PPAP Capable.

ESD8451, SZESD8451

PACKAGE DIMENSIONS

X3DFN2, 0.62x0.32, 0.355P, (0201)
CASE 152AF
ISSUE A

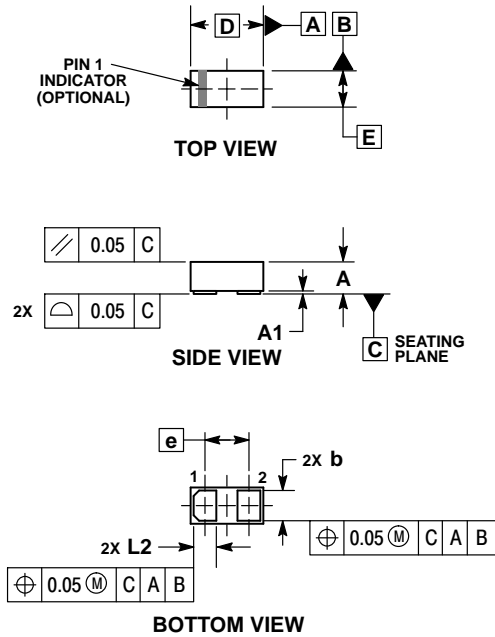

NOTES:

1. DIMENSIONING AND TOLERANCING PER ASME Y14.5M, 1994.
2. CONTROLLING DIMENSION: MILLIMETERS.

| MILLIMETERS | | |
|-------------|-----------|------|
| DIM | MIN | MAX |
| A | 0.25 | 0.33 |
| A1 | — | 0.05 |
| b | 0.22 | 0.28 |
| D | 0.58 | 0.66 |
| E | 0.28 | 0.36 |
| e | 0.355 BSC | |
| L2 | 0.17 | 0.23 |

RECOMMENDED MOUNTING FOOTPRINT*

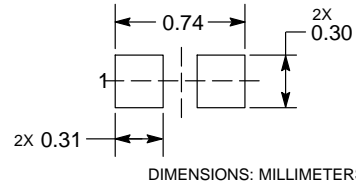

See Application Note AND8398/D for more mounting details
*For additional information on our Pb-Free strategy and soldering details, please download the ON Semiconductor Soldering and Mounting Techniques Reference Manual, SOLDERRM/D.

ESD8451, SZESD8451

PACKAGE DIMENSIONS

XDFN2 1.0x0.6, 0.65P (SOD-882) CASE 711AM ISSUE O

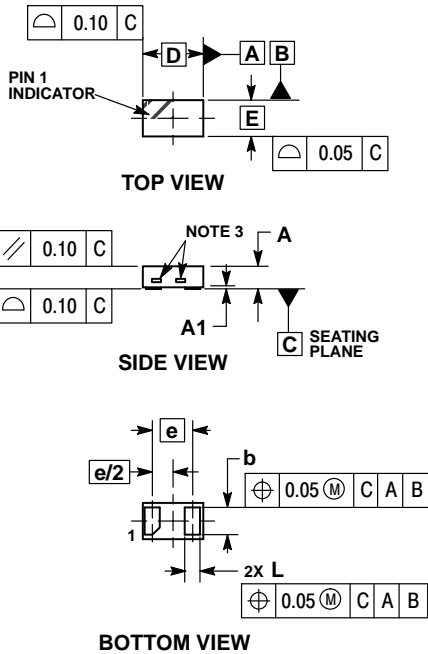

NOTES:

1. DIMENSIONING AND TOLERANCING PER ASME Y14.5M, 1994.
2. CONTROLLING DIMENSION: MILLIMETERS.
3. EXPOSED COPPER ALLOWED AS SHOWN.

| MILLIMETERS | | |
|-------------|----------|------|
| DIM | MIN | MAX |
| A | 0.34 | 0.44 |
| A1 | --- | 0.05 |
| b | 0.43 | 0.53 |
| D | 1.00 BSC | |
| E | 0.60 BSC | |
| e | 0.65 BSC | |
| L | 0.20 | 0.30 |

RECOMMENDED SOLDER FOOTPRINT*

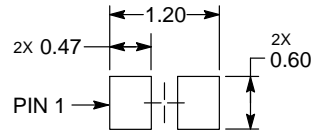

DIMENSIONS: MILLIMETERS

*For additional information on our Pb-Free strategy and soldering details, please download the ON Semiconductor Soldering and Mounting Techniques Reference Manual, SOLDERRM/D.

HDMI is a registered trademark of HDMI Licensing, LLC.

ON Semiconductor and are trademarks of Semiconductor Components Industries, LLC dba ON Semiconductor or its subsidiaries in the United States and/or other countries. ON Semiconductor owns the rights to a number of patents, trademarks, copyrights, trade secrets, and other intellectual property. A listing of ON Semiconductor's product/patent coverage may be accessed at www.onsemi.com/site/pdf/Patent-Marking.pdf. ON Semiconductor reserves the right to make changes without further notice to any products herein. ON Semiconductor makes no warranty, representation or guarantee regarding the suitability of its products for any particular purpose, nor does ON Semiconductor assume any liability arising out of the application or use of any product or circuit, and specifically disclaims any and all liability, including without limitation special, consequential or incidental damages. Buyer is responsible for its products and applications using ON Semiconductor products, including compliance with all laws, regulations and safety requirements or standards, regardless of any support or applications information provided by ON Semiconductor. "Typical" parameters which may be provided in ON Semiconductor data sheets and/or specifications can and do vary in different applications and actual performance may vary over time. All operating parameters, including "Typicals" must be validated for each customer application by customer's technical experts. ON Semiconductor does not convey any license under its patent rights nor the rights of others. ON Semiconductor products are not designed, intended, or authorized for use as a critical component in life support systems or any FDA Class 3 medical devices or medical devices with a same or similar classification in a foreign jurisdiction or any devices intended for implantation in the human body. Should Buyer purchase or use ON Semiconductor products for any such unintended or unauthorized application, Buyer shall indemnify and hold ON Semiconductor and its officers, employees, subsidiaries, affiliates, and distributors harmless against all claims, costs, damages, and expenses, and reasonable attorney fees arising out of, directly or indirectly, any claim of personal injury or death associated with such unintended or unauthorized use, even if such claim alleges that ON Semiconductor was negligent regarding the design or manufacture of the part. ON Semiconductor is an Equal Opportunity/Affirmative Action Employer. This literature is subject to all applicable copyright laws and is not for resale in any manner.

PUBLICATION ORDERING INFORMATION

LITERATURE FULFILLMENT:

Literature Distribution Center for ON Semiconductor
19521 E. 32nd Pkwy, Aurora, Colorado 80011 USA
Phone: 303-675-2175 or 800-344-3860 Toll Free USA/Canada
Fax: 303-675-2176 or 800-344-3867 Toll Free USA/Canada
Email: orderlit@onsemi.com

N. American Technical Support: 800-282-9855 Toll Free
USA/Canada
Europe, Middle East and Africa Technical Support:
Phone: 421 33 790 2910
Japan Customer Focus Center
Phone: 81-3-5817-1050

ON Semiconductor Website: www.onsemi.com
Order Literature: <http://www.onsemi.com/orderlit>

For additional information, please contact your local Sales Representative