

Optocoupler, Phototransistor Output (Dual, Quad Channel)

Dual Channel

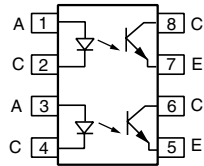

Quad Channel

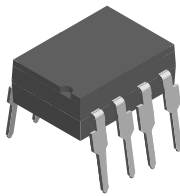
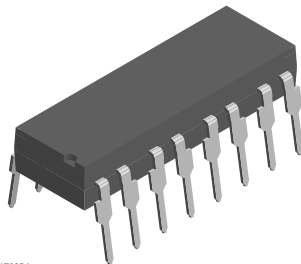

H79054

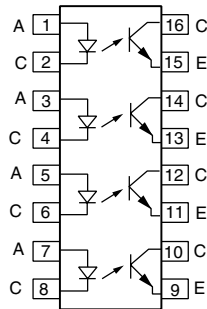

FEATURES

- Alternate source to TLP621-2/-4 and TLP621GB-2/-4
- High collector emitter voltage, $BV_{CEO} = 70\text{ V}$
- Dual and quad packages feature:
 - Lower pin and parts count
 - Better channel to channel CTR match
 - Improved common mode rejection
- Isolation test voltage, 5300 V_{RMS}
- Lead (Pb)-free component
- Component in accordance to RoHS 2002/95/EC and WEEE 2002/96/EC



RoHS
COMPLIANT

AGENCY APPROVALS

- UL1577, file no. E52744 system code H or J, double protection
- DIN EN 60747-5-2 (VDE 0884)/DIN EN 60747-5-5 pending available with option 1
- BSI IEC 60950; IEC 60065
- FIMKO

DESCRIPTION

The ILD621/ILQ621 and ILD621GB/ILQ621GB are multi-channel phototransistor optocouplers that use GaAs IRLED emitters and high gain NPN silicon phototransistors. These devices are constructed using double molded insulation technology. This assembly process offers a withstand test voltage of 7500 VDC.

The ILD621/ILQ621GB is well suited for CMOS interfacing given the CTR_{CEsat} of 30 % minimum at I_F of 1.0 mA. High gain linear operation is guaranteed by a minimum CTR_{CE} of 100 % at 5.0 mA. The ILD/Q621 has a guaranteed CTR_{CE} 50 % minimum at 5.0 mA. The transparent ion shield insures stable DC gain in applications such as power supply feedback circuits, where constant DC V_{IO} voltages are present.

ORDER INFORMATION

PART	REMARKS
ILD621	CTR > 50 %, dual, DIP-8
ILD621GB	CTR > 100 %, dual, DIP-8
ILQ621	CTR > 50 %, quad, DIP-16
ILQ621GB	CTR > 100 %, quad, DIP-16
ILD621-X006	CTR > 50 %, dual, DIP-8 400 mil

ILD621/ILD621GB/ILQ621/ILQ621GB



Vishay Semiconductors

Optocoupler, Phototransistor Output
(Dual, Quad Channel)

ORDER INFORMATION	
PART	REMARKS
ILD621-X007	CTR > 50 %, dual, SMD-8 (option 7)
ILD621-X009	CTR > 50 %, dual, SMD-8 (option 9)
ILD621GB-X007	CTR > 100 %, dual, SMD-8 (option 7)
ILQ621-X006	CTR > 50 %, quad, DIP-16 400 mil
ILQ621-X007	CTR > 50 %, quad, SMD-16 (option 7)
ILQ621-X009	CTR > 50 %, quad, SMD-16 (option 9)
ILQ621GB-X006	CTR > 100 %, quad, DIP-16 400 mil
ILQ621GB-X007	CTR > 100 %, quad, SMD-16 (option 7)
ILQ621GB-X009	CTR > 100 %, quad, SMD-16 (option 9)

Note

For additional information on the available options refer to option information.

ABSOLUTE MAXIMUM RATINGS (1)					
PARAMETER	TEST CONDITION	PART	SYMBOL	VALUE	UNIT
INPUT					
Reverse voltage			V_R	6.0	V
Forward current			I_F	60	mA
Surge current			I_{FSM}	1.5	A
Power dissipation			P_{diss}	100	mW
Derate from 25 °C				1.33	mW/°C
OUTPUT					
Collector emitter reverse voltage			V_{ECO}	70	V
Collector current			I_C	50	mA
	$t < 1.0$ ms		I_C	100	mA
Power dissipation			P_{diss}	150	mW
Derate from 25 °C				- 2.0	mW/°C
COUPLER					
Isolation test voltage	$t = 1.0$ s		V_{ISO}	5300	V_{RMS}
Package dissipation		ILD621		400	mW
		ILD621GB		400	mW
Derate from 25 °C				5.33	mW/°C
Package dissipation		ILQ621		500	mW
		ILQ621GB		500	mW
Derate from 25 °C				6.67	mW/°C
Creepage distance				≥ 7.0	mm
Clearance distance				≥ 7.0	mm
Isolation resistance	$V_{IO} = 500$ V, $T_{amb} = 25$ °C		R_{IO}	≥ 10^{12}	Ω
	$V_{IO} = 500$ V, $T_{amb} = 100$ °C		R_{IO}	≥ 10^{11}	Ω
Storage temperature			T_{stg}	- 55 to + 150	°C
Operating temperature			T_{amb}	- 55 to + 100	°C
Junction temperature			T_j	100	°C
Soldering temperature (2)	2.0 mm from case bottom		T_{sld}	260	°C

Notes

(1) $T_{amb} = 25$ °C, unless otherwise specified.

Stresses in excess of the absolute maximum ratings can cause permanent damage to the device. Functional operation of the device is not implied at these or any other conditions in excess of those given in the operational sections of this document. Exposure to absolute maximum ratings for extended periods of the time can adversely affect reliability.

(2) Refer to reflow profile for soldering conditions for surface mounted devices (SMD). Refer to wave profile for soldering conditions for through hole devices (DIP).



ILD621/ILD621GB/ILQ621/ILQ621GB

Optocoupler, Phototransistor Output
(Dual, Quad Channel)

Vishay Semiconductors

ELECTRICAL CHARACTERISTICS							
PARAMETER	TEST CONDITION	PART	SYMBOL	MIN.	TYP.	MAX.	UNIT
INPUT							
Forward voltage	$I_F = 10 \text{ mA}$		V_F	1.0	1.15	1.3	V
Reverse current	$V_R = 6.0 \text{ V}$		I_R		0.01	10	μA
Capacitance	$V_R = 0 \text{ V}, f = 1.0 \text{ MHz}$		C_O		40		pF
Thermal resistance, junction to lead			R_{THJL}		750		K/W
OUTPUT							
Collector emitter capacitance	$V_{CE} = 5.0 \text{ V}, f = 1.0 \text{ MHz}$		C_{CE}		6.8		pF
Collector emitter leakage current	$V_{CE} = 24 \text{ V}$		I_{CEO}		10	100	nA
			I_{CEO}		20	50	μA
Thermal resistance, junction to lead			R_{THJL}		500		K/W
COUPLER							
Capacitance (input to output)	$V_{IO} = 0 \text{ V}, f = 1.0 \text{ MHz}$		C_{IO}	0.8			pF
Insulation resistance	$V_{IO} = 500 \text{ V}$			10^{12}			Ω
Channel to channel insulation				500			VAC
Collector emitter saturation voltage	$I_F = 8.0 \text{ mA}, I_{CE} = 2.4 \text{ mA}$	ILD621	V_{CEsat}			0.4	V
		ILQ621					
Collector emitter saturation voltage	$I_F = 1.0 \text{ mA}, I_{CE} = 0.2 \text{ mA}$	ILD621GB	V_{CEsat}			0.4	V
		ILQ621GB					

Note

$T_{amb} = 25 \text{ }^\circ\text{C}$, unless otherwise specified.

Minimum and maximum values are testing requirements. Typical values are characteristics of the device and are the result of engineering evaluation. Typical values are for information only and are not part of the testing requirements.

CURRENT TRANSFER RATIO							
PARAMETER	TEST CONDITION	PART	SYMBOL	MIN.	TYP.	MAX.	UNIT
Channel/channel CTR match	$I_F = 5.0 \text{ mA}, V_{CE} = 5.0 \text{ V}$		CTR _X / CTR _Y	1 to 1		3 to 1	%
Current transfer ratio (collector emitter saturated)	$I_F = 1.0 \text{ mA}, V_{CE} = 0.4 \text{ V}$	ILD621	CTR _{CEsat}		60		%
		ILQ621	CTR _{CEsat}		60		%
		ILD621GB	CTR _{CEsat}	30			%
		ILQ621GB	CTR _{CEsat}	30			%
Current transfer ratio (collector emitter)	$I_F = 5.0 \text{ mA}, V_{CE} = 5.0 \text{ V}$	ILD621	CTR _{CE}	50	80	600	%
		ILQ621	CTR _{CE}	50	80	600	%
		ILD621GB	CTR _{CE}	100	200	600	%
		ILQ621GB	CTR _{CE}	100	200	600	%

SWITCHING CHARACTERISTICS							
PARAMETER	TEST CONDITION	SYMBOL	MIN.	TYP.	MAX.	UNIT	
NON-SATURATED							
On time	$I_F = \pm 10 \text{ mA}, V_{CC} = 5.0 \text{ V}, R_L = 75 \Omega, 50 \% \text{ of } V_{PP}$	t_{on}		3.0		μs	
Rise time	$I_F = \pm 10 \text{ mA}, V_{CC} = 5.0 \text{ V}, R_L = 75 \Omega, 50 \% \text{ of } V_{PP}$	t_r		2.0		μs	
Off time	$I_F = \pm 10 \text{ mA}, V_{CC} = 5.0 \text{ V}, R_L = 75 \Omega, 50 \% \text{ of } V_{PP}$	t_{off}		2.3		μs	
Fall time	$I_F = \pm 10 \text{ mA}, V_{CC} = 5.0 \text{ V}, R_L = 75 \Omega, 50 \% \text{ of } V_{PP}$	t_f		2.0		μs	
Propagation H to L	$I_F = \pm 10 \text{ mA}, V_{CC} = 5.0 \text{ V}, R_L = 75 \Omega, 50 \% \text{ of } V_{PP}$	t_{PHL}		1.1		μs	
Propagation L to H	$I_F = \pm 10 \text{ mA}, V_{CC} = 5.0 \text{ V}, R_L = 75 \Omega, 50 \% \text{ of } V_{PP}$	t_{PLH}		2.5		μs	

SWITCHING CHARACTERISTICS						
PARAMETER	TEST CONDITION	SYMBOL	MIN.	TYP.	MAX.	UNIT
SATURATED						
On time	$I_F = \pm 10 \text{ mA}$, $V_{CC} = 5.0 \text{ V}$, $R_L = 1 \text{ k}\Omega$, $V_{TH} = 1.5 \text{ V}$	t_{on}		4.3		μs
Rise time	$I_F = \pm 10 \text{ mA}$, $V_{CC} = 5.0 \text{ V}$, $R_L = 1 \text{ k}\Omega$, $V_{TH} = 1.5 \text{ V}$	t_r		2.8		μs
Off time	$I_F = \pm 10 \text{ mA}$, $V_{CC} = 5.0 \text{ V}$, $R_L = 1 \text{ k}\Omega$, $V_{TH} = 1.5 \text{ V}$	t_{off}		2.5		μs
Fall time	$I_F = \pm 10 \text{ mA}$, $V_{CC} = 5.0 \text{ V}$, $R_L = 1 \text{ k}\Omega$, $V_{TH} = 1.5 \text{ V}$	t_f		11		μs
Propagation H to L	$I_F = \pm 10 \text{ mA}$, $V_{CC} = 5.0 \text{ V}$, $R_L = 1 \text{ k}\Omega$, $V_{TH} = 1.5 \text{ V}$	t_{PHL}		2.6		μs
Propagation L to H	$I_F = \pm 10 \text{ mA}$, $V_{CC} = 5.0 \text{ V}$, $R_L = 1 \text{ k}\Omega$, $V_{TH} = 1.5 \text{ V}$	t_{PLH}		7.2		μs

COMMON MODE TRANSIENT IMMUNITY						
PARAMETER	TEST CONDITION	SYMBOL	MIN.	TYP.	MAX.	UNIT
Common mode rejection, output high	$V_{CM} = 50 \text{ V}_{P-P}$, $R_L = 1.0 \text{ k}\Omega$, $I_F = 0 \text{ mA}$	CM_H		5000		$\text{V}/\mu\text{s}$
Common mode rejection, output low	$V_{CM} = 50 \text{ V}_{P-P}$, $R_L = 1.0 \text{ k}\Omega$, $I_F = 10 \text{ mA}$	CM_L		5000		$\text{V}/\mu\text{s}$

TYPICAL CHARACTERISTICS

$T_{amb} = 25 \text{ }^\circ\text{C}$, unless otherwise specified

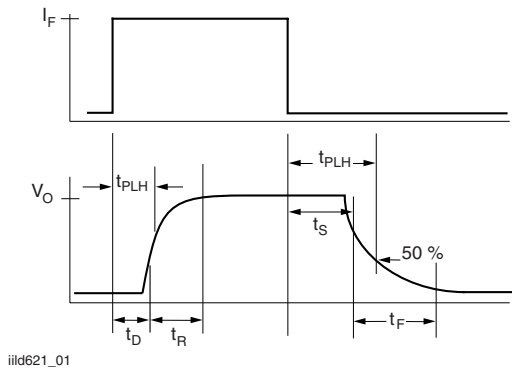

Fig. 1 - Non-Saturated Switching Timing

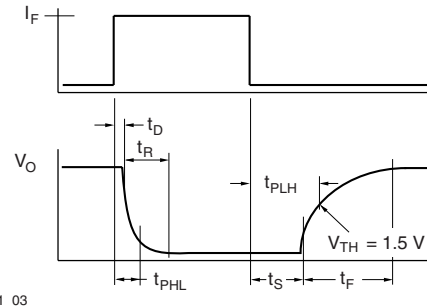

Fig. 3 - Saturated Switching Timing

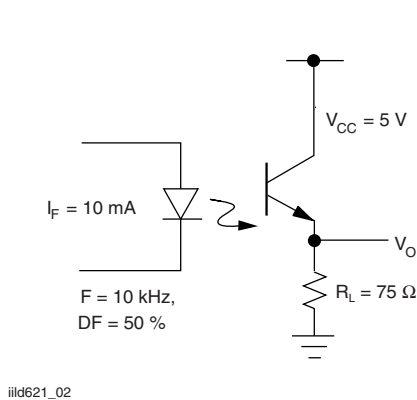

Fig. 2 - Non-Saturated Switching Timing

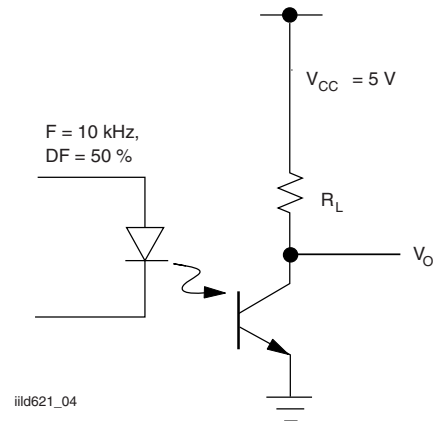

Fig. 4 - Saturated Switching Timing



ILD621/ILD621GB/ILQ621/ILQ621GB

Optocoupler, Phototransistor Output
(Dual, Quad Channel)

Vishay Semiconductors

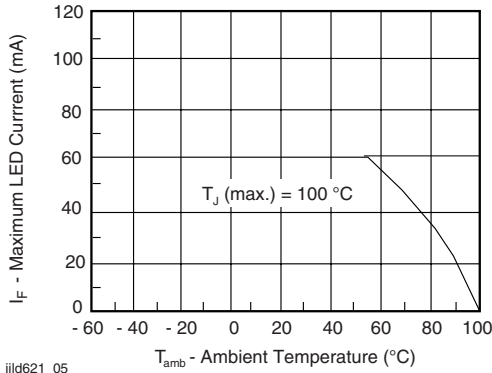

Fig. 5 - Maximum LED Current vs. Ambient Temperature

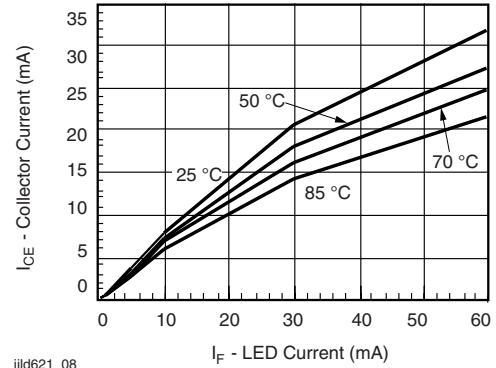

Fig. 8 - Collector Emitter Current vs. Temperature and LED Current

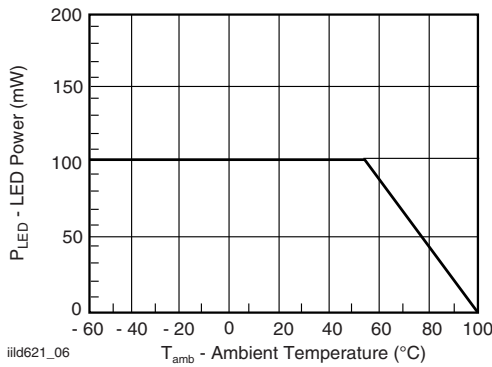

Fig. 6 - Maximum LED Power Dissipation

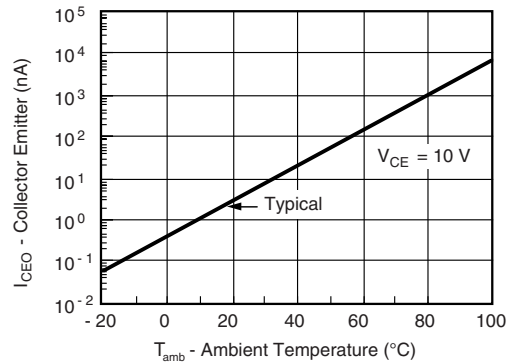

Fig. 9 - Collector Emitter Leakage vs. Temperature

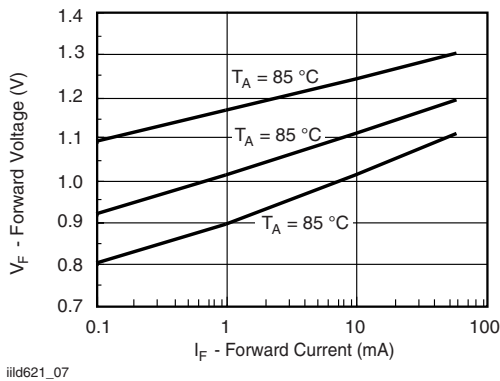

Fig. 7 - Forward Voltage vs. Forward Current

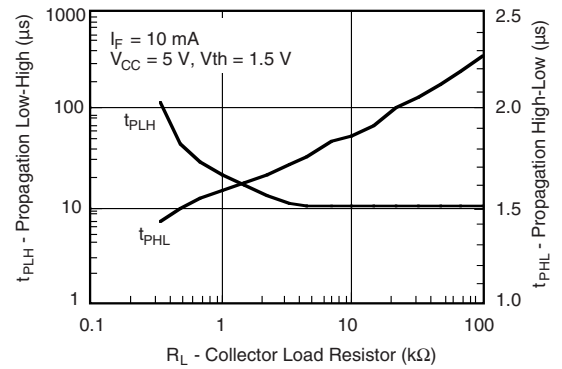

Fig. 10 - Propagation Delay vs. Collector Load Resistor

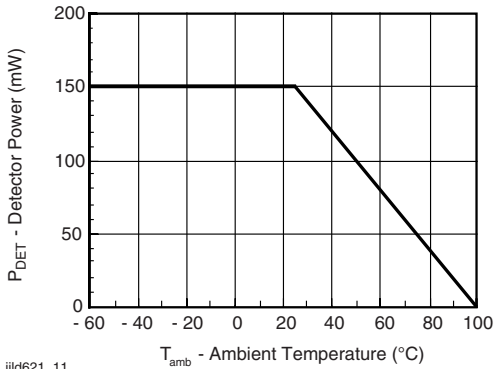

Fig. 11 - Maximum Detector Power Dissipation

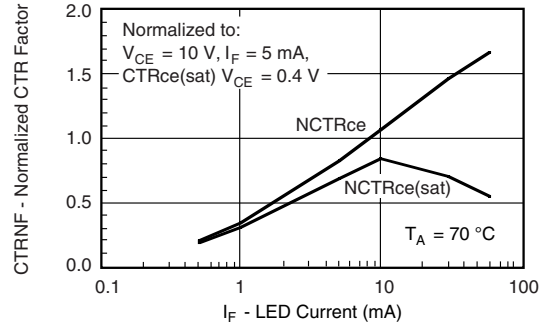

Fig. 14 - Normalization Factor for Non-Saturated and Saturated CTR vs. I_F

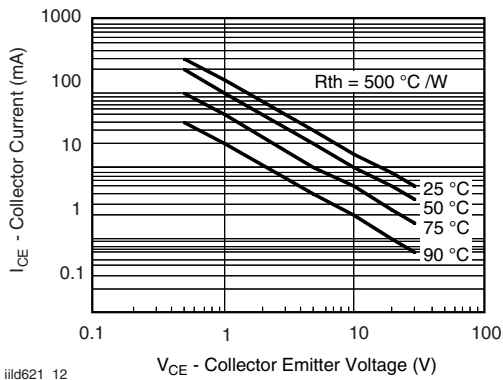

Fig. 12 - Maximum Collector Current vs. Collector Voltage

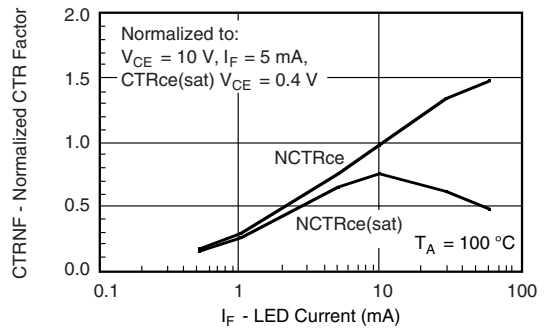

Fig. 15 - Normalization Factor for Non-Saturated and Saturated CTR vs. I_F

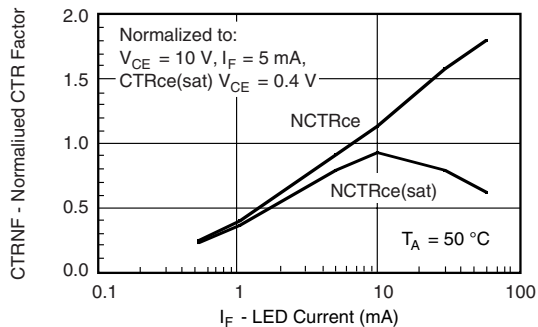

Fig. 13 - Normalization Factor for Non-Saturated and Saturated CTR vs. I_F



ILD621/ILD621GB/ILQ621/ILQ621GB

Optocoupler, Phototransistor Output
(Dual, Quad Channel)

Vishay Semiconductors

PACKAGE DIMENSIONS in inches (millimeters)

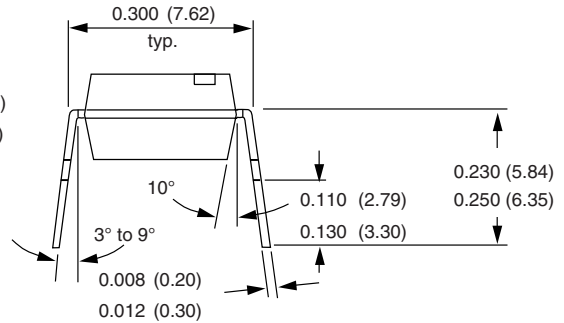
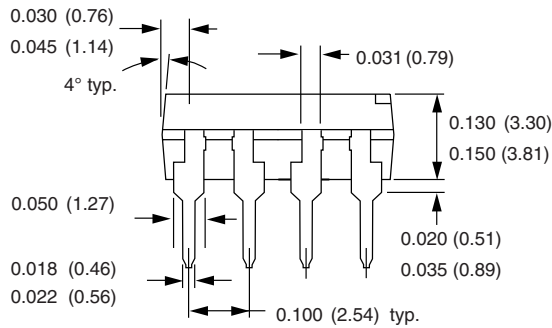
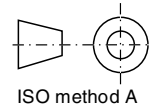
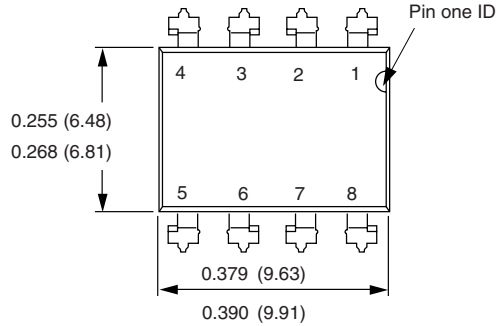

i178006

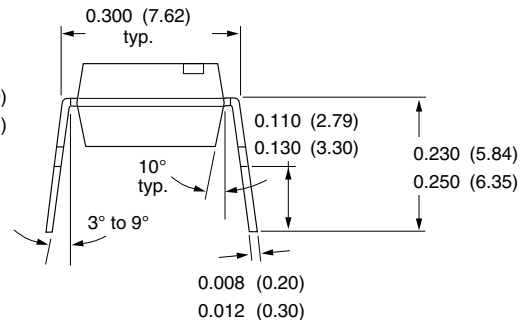
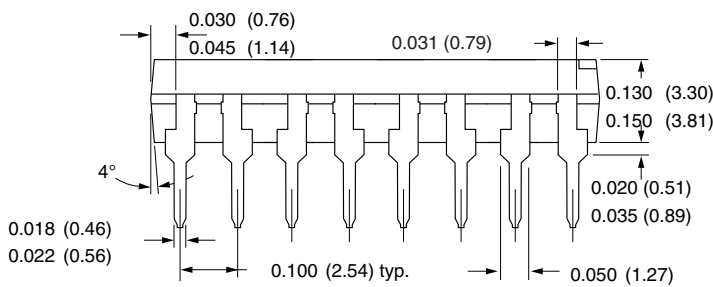
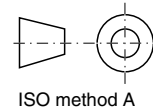
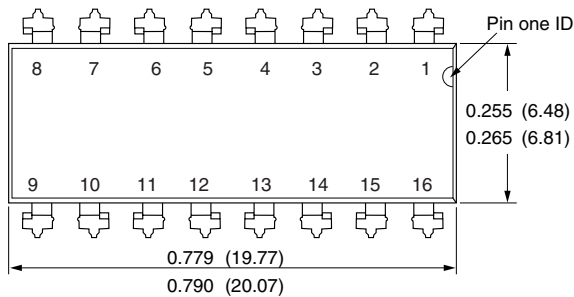

i178007

ILD621/ILD621GB/ILQ621/ILQ621GB



Vishay Semiconductors

Optocoupler, Phototransistor Output
(Dual, Quad Channel)

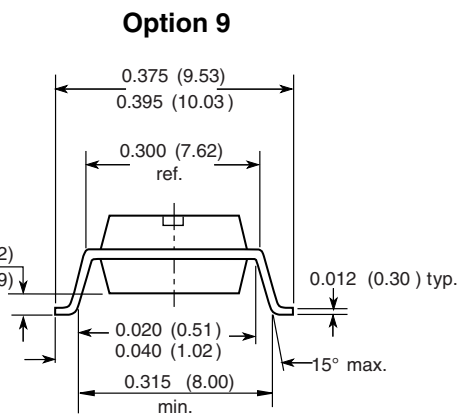
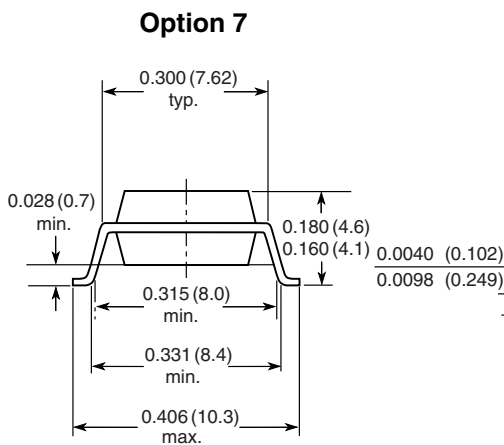
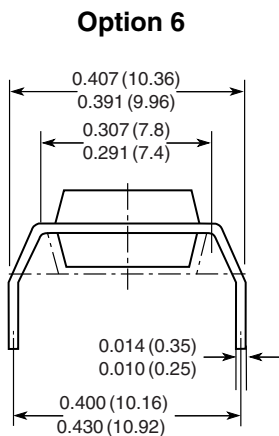

18450



OZONE DEPLETING SUBSTANCES POLICY STATEMENT

It is the policy of Vishay Semiconductor GmbH to

1. Meet all present and future national and international statutory requirements.
2. Regularly and continuously improve the performance of our products, processes, distribution and operating systems with respect to their impact on the health and safety of our employees and the public, as well as their impact on the environment.

It is particular concern to control or eliminate releases of those substances into the atmosphere which are known as ozone depleting substances (ODSs).

The Montreal Protocol (1987) and its London Amendments (1990) intend to severely restrict the use of ODSs and forbid their use within the next ten years. Various national and international initiatives are pressing for an earlier ban on these substances.

Vishay Semiconductor GmbH has been able to use its policy of continuous improvements to eliminate the use of ODSs listed in the following documents.

1. Annex A, B and list of transitional substances of the Montreal Protocol and the London Amendments respectively.
2. Class I and II ozone depleting substances in the Clean Air Act Amendments of 1990 by the Environmental Protection Agency (EPA) in the USA.
3. Council Decision 88/540/EEC and 91/690/EEC Annex A, B and C (transitional substances) respectively.

Vishay Semiconductor GmbH can certify that our semiconductors are not manufactured with ozone depleting substances and do not contain such substances.

We reserve the right to make changes to improve technical design
and may do so without further notice.

Parameters can vary in different applications. All operating parameters must be validated for each customer application by the customer. Should the buyer use Vishay Semiconductors products for any unintended or unauthorized application, the buyer shall indemnify Vishay Semiconductors against all claims, costs, damages, and expenses, arising out of, directly or indirectly, any claim of personal damage, injury or death associated with such unintended or unauthorized use.

Vishay Semiconductor GmbH, P.O.B. 3535, D-74025 Heilbronn, Germany



Disclaimer

All product specifications and data are subject to change without notice.

Vishay Intertechnology, Inc., its affiliates, agents, and employees, and all persons acting on its or their behalf (collectively, "Vishay"), disclaim any and all liability for any errors, inaccuracies or incompleteness contained herein or in any other disclosure relating to any product.

Vishay disclaims any and all liability arising out of the use or application of any product described herein or of any information provided herein to the maximum extent permitted by law. The product specifications do not expand or otherwise modify Vishay's terms and conditions of purchase, including but not limited to the warranty expressed therein, which apply to these products.

No license, express or implied, by estoppel or otherwise, to any intellectual property rights is granted by this document or by any conduct of Vishay.

The products shown herein are not designed for use in medical, life-saving, or life-sustaining applications unless otherwise expressly indicated. Customers using or selling Vishay products not expressly indicated for use in such applications do so entirely at their own risk and agree to fully indemnify Vishay for any damages arising or resulting from such use or sale. Please contact authorized Vishay personnel to obtain written terms and conditions regarding products designed for such applications.

Product names and markings noted herein may be trademarks of their respective owners.



Disclaimer

ALL PRODUCT, PRODUCT SPECIFICATIONS AND DATA ARE SUBJECT TO CHANGE WITHOUT NOTICE TO IMPROVE RELIABILITY, FUNCTION OR DESIGN OR OTHERWISE.

Vishay Intertechnology, Inc., its affiliates, agents, and employees, and all persons acting on its or their behalf (collectively, "Vishay"), disclaim any and all liability for any errors, inaccuracies or incompleteness contained in any datasheet or in any other disclosure relating to any product.

Vishay makes no warranty, representation or guarantee regarding the suitability of the products for any particular purpose or the continuing production of any product. To the maximum extent permitted by applicable law, Vishay disclaims (i) any and all liability arising out of the application or use of any product, (ii) any and all liability, including without limitation special, consequential or incidental damages, and (iii) any and all implied warranties, including warranties of fitness for particular purpose, non-infringement and merchantability.

Statements regarding the suitability of products for certain types of applications are based on Vishay's knowledge of typical requirements that are often placed on Vishay products in generic applications. Such statements are not binding statements about the suitability of products for a particular application. It is the customer's responsibility to validate that a particular product with the properties described in the product specification is suitable for use in a particular application. Parameters provided in datasheets and / or specifications may vary in different applications and performance may vary over time. All operating parameters, including typical parameters, must be validated for each customer application by the customer's technical experts. Product specifications do not expand or otherwise modify Vishay's terms and conditions of purchase, including but not limited to the warranty expressed therein.

Hyperlinks included in this datasheet may direct users to third-party websites. These links are provided as a convenience and for informational purposes only. Inclusion of these hyperlinks does not constitute an endorsement or an approval by Vishay of any of the products, services or opinions of the corporation, organization or individual associated with the third-party website. Vishay disclaims any and all liability and bears no responsibility for the accuracy, legality or content of the third-party website or for that of subsequent links.

Except as expressly indicated in writing, Vishay products are not designed for use in medical, life-saving, or life-sustaining applications or for any other application in which the failure of the Vishay product could result in personal injury or death. Customers using or selling Vishay products not expressly indicated for use in such applications do so at their own risk. Please contact authorized Vishay personnel to obtain written terms and conditions regarding products designed for such applications.

No license, express or implied, by estoppel or otherwise, to any intellectual property rights is granted by this document or by any conduct of Vishay. Product names and markings noted herein may be trademarks of their respective owners.