

ITEM	Q'TY	PART NUMBER	PART DESCRIPTION
1	1	R4XX	2x4mm Rectangular LED, See Page 2
2	1	RL2-XXX	Molded Rectangular LED Mount

REV.	DESCRIPTION	DATE	APPROVED
A	Engineering Update w/o Changes	03/01/04	M. C.
B	Corrected LED P/N Typo On Page 2	05/06/13	T. Y.
C	Engineering Update w/o Changes	06/25/16	J. C.

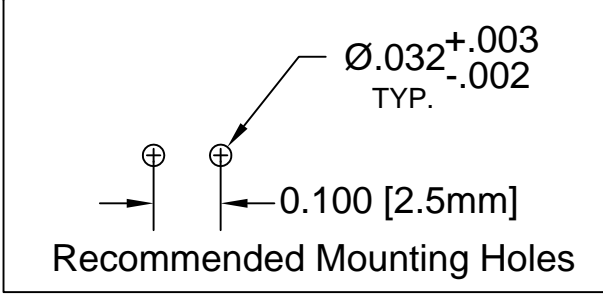
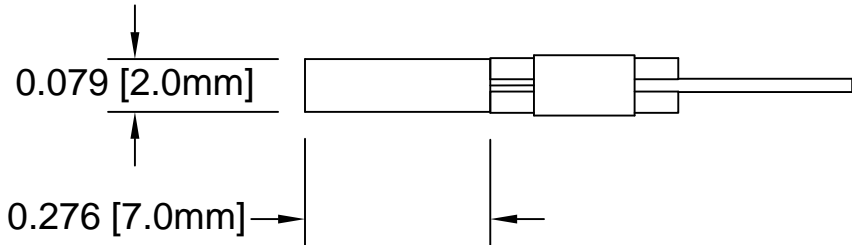
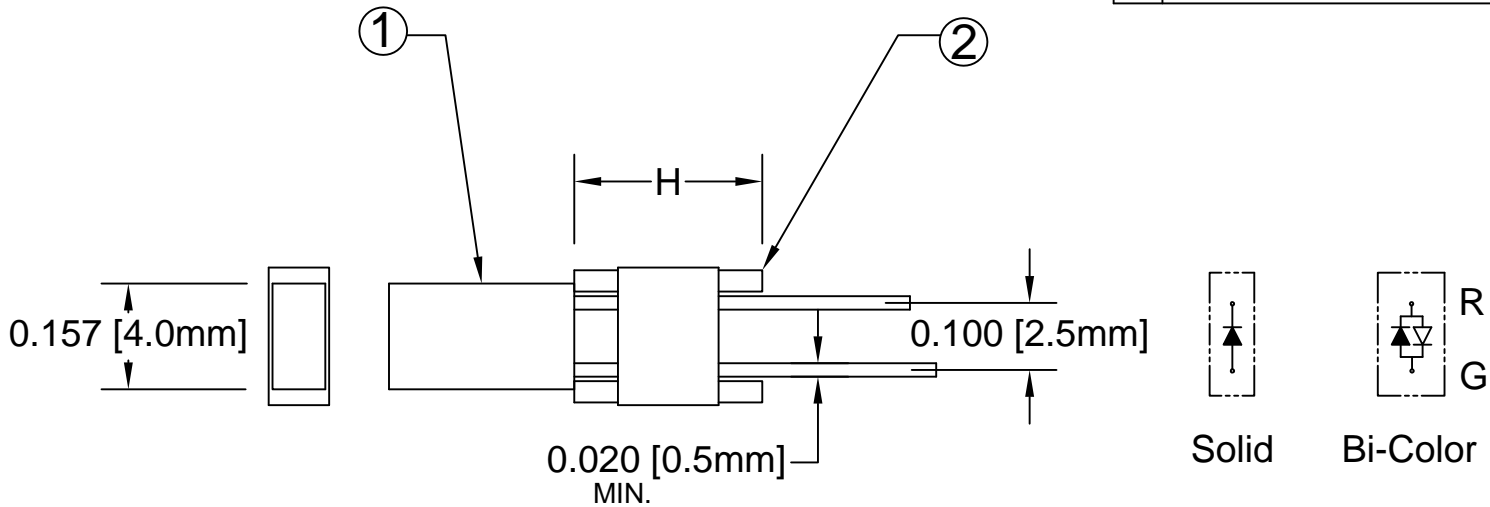

EXAMPLE:
RL21604GD(T)
 RL - Series
 2 - Height "H" *
 16 - LED Color & Lens Appearance.
 04 - Optional Tape and Reel
 G - Omit R when ordering.
 D - (T) -

* XXX = Height "H"
 Available Range From 0.200" ~ 0.350"
 In 0.010" Increments

ABSOLUTE MAXIMUM RATINGS (Ta=25°C)

REVERSE VOLTAGE _____	5V
REVERSE CURRENT _____	100uA
OPERATING TEMPERATURE RANGE _____	-20° C - 80° C
STORAGE TEMPERATURE _____	-20° C - 80° C
LEAD SOLDERING TEMPERATURE(1/16" FROM BODY) _____	260° C FOR 5 SECONDS

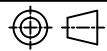
STANDARD TOLERANCE (UNLESS OTHERWISE SPECIFIED)		 4 THOMAS, IRVINE, CA. 92618 TEL: (949) 951-8808 FAX: (949) 951-3974	
DECIMALS	ANGULAR		
.X ± .1	X° ± 1°		TITLE: MOLDED RECTANGULAR LED MOUNT ASSEMBLY
.XX ± .02			PART NO: RL2XXX4XX
.XXX ± .010		DESIGNED: T. Yin	DATE: 03/01/04
		CHECKED: D. Green	DATE: 03/01/04
			REVISION: C
		CAGE CODE : 32559	SHEET # 1 OF 2
CAD GENERATED DOCUMENT. DO NOT MEASURE DRAWING.			

REV.	DESCRIPTION	DATE	APPROVED
	SEE SHEET #1		

LED Assy P/N	Peak Wavelength λ_p (nm)	Emitted Color	Lens Appearance	Abs. Max. Rating	LED Electro-Optical Data @ 20mA			Viewing Angle $2\theta_{1/2}$ (Deg)	LED P/N
					Vf (V)		Iv (mcd)		
					I _f (mA)	TYP	MAX		
RL2XXX4BWD	430	BLUE	DIFFUSED	30	4.0	4.5	4.5	120	R4BWD
RL2XXX4GD	568	GREEN	DIFFUSED	30	2.2	2.6	7.0	120	R4GD
RL2XXX4YD	585	YELLOW	DIFFUSED	30	2.1	2.6	6.0	120	R4YD
RL2XXX4RD	655	RED	DIFFUSED	40	1.7	2.0	0.6	120	R4RD
RL2XXX4BC	635	HE RED	DIFFUSED	30	2.0	2.6	5.5	125	R4BC
	568	GREEN		30	2.2	2.6	5.5		

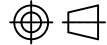
STANDARD TOLERANCE (UNLESS OTHERWISE SPECIFIED) $\pm 10\%$ ALL VALUES ANGULAR		 4 THOMAS, IRVINE, CA. 92618 TEL: (949) 951-8808 FAX: (949) 951-3974	
		 TITLE: MOLDED RECTANGULAR LED MOUNT ASSEMBLY	
DESIGNED: T. Yin	DATE: 03/01/04	PART NO: RL2XXX4XX	REVISION: C
CHECKED: D. Green	DATE: 03/01/04	CAGE CODE : 32559	SHEET # 2 OF 2
CAD GENERATED DOCUMENT. DO NOT MEASURE DRAWING.			