1.2A High-Brightness Flash LED Driver with Single-Wire Serial Interface

Features

- Up to 1.2A Flash LED Driving Current
- Highly Efficient Synchronous Boost Driver
- Control through Single-Wire Serial Interface or External Control Pin
- Input Voltage Range: 2.7V to 5.5V
- True Load Disconnect
- Configurable Safety Time-Out Protection
- Output Overvoltage Protection (OVP)
- LED Short Detection and Protection
- 1 μ A Shutdown Current
- Available in 9-Bump 1.30 mm x 1.30 mm WLCSP Package

Applications

- Camera Phones/Mobile Handsets
- Cell Phones/Smartphones
- LED Light for Image Capture/Auto-Focus/White Balance
- Handset Video Light (Torch Light)
- Digital Cameras
- Portable Applications

General Description

The MIC2873 is a high-current, high-efficiency Flash LED driver. The LED driver current is generated by an integrated inductive boost converter with a 2 MHz switching frequency, which allows for the use of a very small inductor and output capacitor. These features make the MIC2873 an ideal solution for high-resolution camera phone LED Flash light driver applications.

MIC2873 operates in either Flash or Torch mode that can be controlled through the single-wire serial interface and/or external control pin. A robust single-wire serial interface allows the host processor to control the LED current and brightness. The MIC2873 is available in a 9-bump 1.30 mm x 1.30 mm WLCSP package.

MIC2873

Package Type

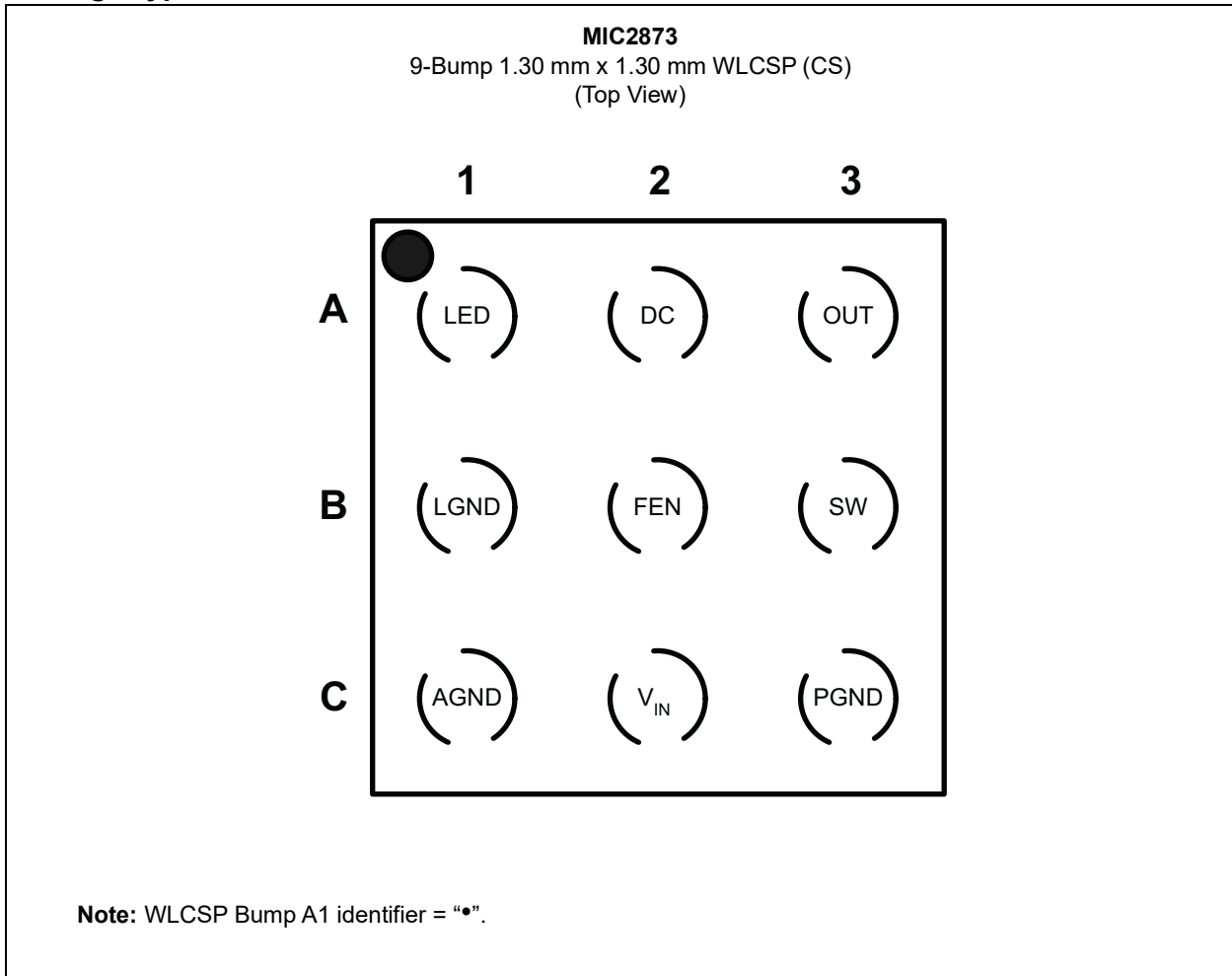

Typical Application Schematic

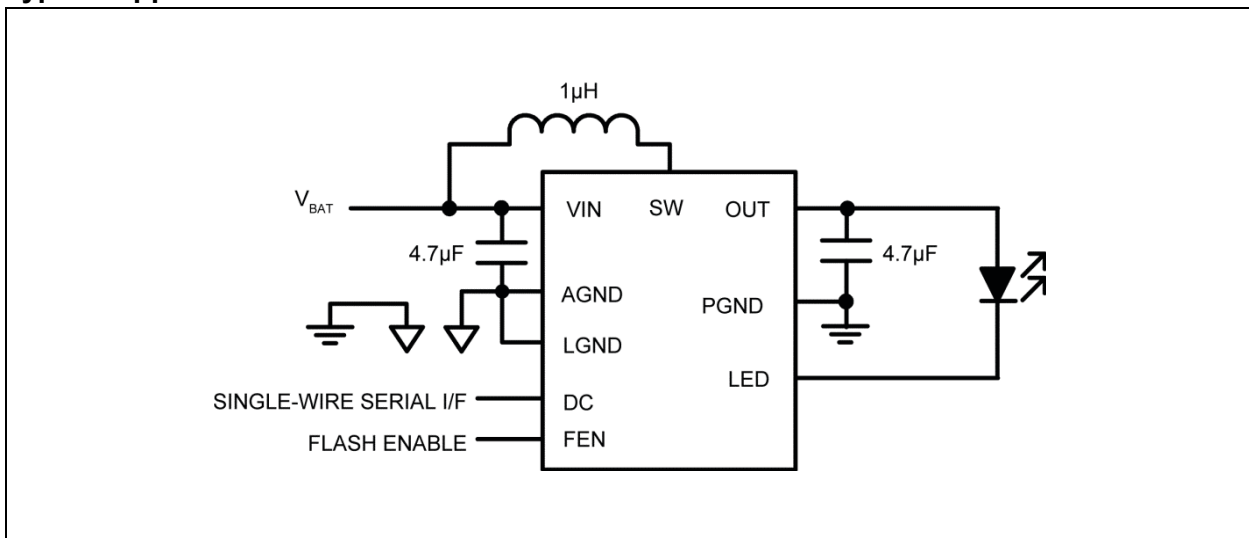

Functional Block Diagram

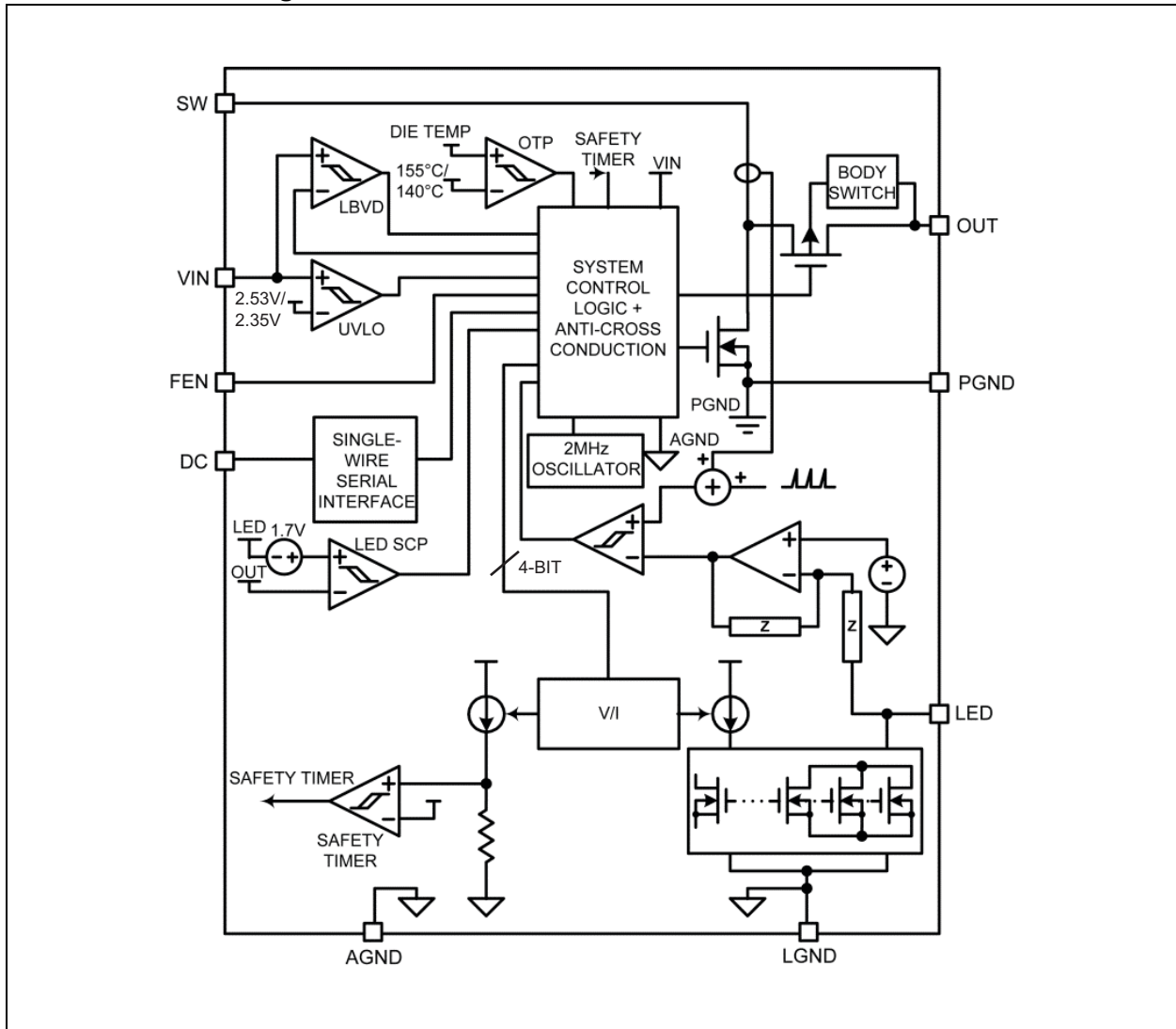

MIC2873

1.0 ELECTRICAL CHARACTERISTICS

Absolute Maximum Ratings†

Input Voltage (V_{IN}).....	-0.3V to +6.0V
General I/O Voltage (V_{FEN}).....	-0.3V to V_{IN}
V_{OUT} and V_{LED} Voltage.....	-0.3V to +6.0V
Single-Wire I/O Voltage (V_{DC}).....	-0.3V to V_{IN}
V_{SW} Voltage.....	-0.3V to +6.0V
ESD Rating ⁽¹⁾	
HBM.....	2 kV
MM.....	200V

† **Notice:** Stresses above those listed under “Maximum Ratings” may cause permanent damage to the device. This is a stress rating only and functional operation of the device at those or any other conditions above those indicated in the operational sections of this specification is not intended. Exposure to maximum rating conditions for extended periods may affect device reliability.

Note 1: Devices are ESD-sensitive. Handling precautions are recommended. Human body model, 1.5 k Ω in series with 100 pF.

Operating Ratings⁽¹⁾

Input Voltage (V_{IN}).....	+2.7V to +5.5V
Enable Input Voltage (V_{FEN}).....	0V to V_{IN}
Single-Wire I/O Voltage (V_{DC}).....	0V to V_{IN}
Power Dissipation (P_D).....	Internally Limited (Note 2)

Note 1: The device is not ensured to function outside the operating range.

- 2:** The maximum allowable power dissipation at any T_A (ambient temperature) is $P_{D(max)} = (T_{J(max)} - T_A)/\theta_{JA}$. Exceeding the maximum allowable power dissipation will result in excessive die temperature and the regulator will go into thermal shutdown.

ELECTRICAL CHARACTERISTICS **Note 1**

Electrical Specifications: unless otherwise specified, $V_{IN} = 3.6V$; $L = 1 \mu H$; $C_{OUT} = 4.7 \mu F$; $I_{OUT} = 100 mA$; $T_A = T_J = +25^\circ C$. **Boldface** values indicate $-40^\circ C \leq T_J \leq +125^\circ C$.

Parameter	Symbol	Min.	Typ.	Max.	Units	Test Conditions
Power Supply						
Supply Voltage Range	V_{IN}	2.7	—	5.5	V	—
UVLO Threshold (Rising)	V_{UVLO_R}	2.41	2.53	2.68	V	—
UVLO Hysteresis	V_{UVLO_HYS}	—	180	—	mV	—
Standby Current	I_{STB}	140	170	205	μA	$V_{DC} = 3.6V$, $V_{FEN} = 0V$, boost regulator and LED current driver are both off
Shutdown Current	I_{SD}	—	1	2	μA	$V_{DC} = 0V$
Maximum Duty Cycle	D_{MAX}	82	86	90	%	—
Minimum Duty Cycle	D_{MIN}	—	6.4	—	%	—
Switch Current Limit	I_{SW}	—	4.1	—	A	$V_{IN} = V_{OUT} = 2.7V$
Switch-On Resistance	$R_{DS(ON)_P}$	—	125	—	$m\Omega$	$I_{SW} = 100 mA$
	$R_{DS(ON)_N}$	—		—		$I_{SW} = 100 mA$
Switch Leakage Current	I_{SW_LK}	—	0.01	1	μA	$V_{DC} = 0V$, $V_{SW} = 5.5V$
Oscillator Frequency	F_{SW}	1.8	2	2.2	MHz	—
Overtemperature Shutdown Threshold	T_{SD}	—	155	—	$^\circ C$	—
Overtemperature Shutdown Hysteresis	T_{SD_HYS}	—	15	—	$^\circ C$	—
Safety Time-out Shutdown	T_{TO}	—	1.25	—	s	Default timer setting
Safety Timer Current Threshold	I_{TO}	—	250	—	mA	Default current threshold setting
Low-Battery Voltage Detection Threshold	V_{LBVD}	—	3.0	—	V	Default LBVD threshold setting
Low-Battery Voltage Detection Threshold Accuracy	—	—	50	—	mV	All low-battery voltage detection threshold settings
LED Short-Circuit Detection Voltage Threshold	V_{SHORT}	1.55	1.7	1.85	V	$V_{OUT} - V_{LED}$
LED Short-Circuit Detection Test Current	I_{TEST}	1.6	2	2.7	mA	—
Current Sink Channel						
Channel Current Accuracy	—	-6	—	6	%	$V_{OUT} = 4.2V$, $I_{LED} = 0.20A$
		-8	—	8		$V_{OUT} = 4.2V$, $I_{LED} = 1.0A$
Current Sink Voltage Dropout	V_{LED}	—	250	—	mV	Boost mode
FEN Control Pin						
FEN High-Level Voltage	V_{FEN_H}	1.3	—	—	V	Flash on
FEN Low-Level Voltage	V_{FEN_L}	—	—	0.6		Flash off
FEN Pull-Down Current	I_{FEN_PD}	—	1.3	5	μA	$V_{FEN} = 5.5V$

Note 1: Specification for packaged product only.

MIC2873

ELECTRICAL CHARACTERISTICS – SINGLE-WIRE INTERFACE (ENSURED BY DESIGN)

Electrical Specifications: unless otherwise specified, $V_{IN} = 3.6V$; $L = 1 \mu H$; $C_{OUT} = 4.7 \mu F$; $I_{OUT} = 100 \text{ mA}$; $T_A = T_J = +25^\circ C$. **Boldface** values indicate $-40^\circ C \leq T_J \leq +125^\circ C$.

Parameter	Symbol	Min.	Typ.	Max.	Units	Test Conditions
Low-Level Input Voltage	V_L	—	—	0.4	V	—
High-Level Input Voltage	V_H	1.3	—	—		—
DC Pull-Down Current	$I_{DC \text{ PD}}$	—	2.8	5	μA	$V_{DC} = 5.5V$
On Time	T_{ON}	0.1	—	72	μs	—
Off Time	T_{OFF}	0.1	—	72	μs	—
Latch Time	T_{LAT}	97	—	324	μs	—
End Time	T_{END}	405	—	—	μs	—

TEMPERATURE SPECIFICATIONS (Note 1)

Parameters	Symbol	Min.	Typ.	Max.	Units	Conditions
Temperature Ranges						
Maximum Junction Temperature Range	T_J	-40	—	150	°C	—
Operating Junction Temperature Range	T_J	-40	—	125	°C	—
Operating Ambient Temperature	T_A	-40	—	85	°C	—
Storage Temperature	T_S	-40	—	150	°C	—
Lead Temperature	—	—	—	260	°C	Soldering, 10s
Package Thermal Resistance						
Thermal Resistance 1.3x1.3 WLCSP-9BL	θ_{JA}	—	84	—	°C/W	—

Note 1: The maximum allowable power dissipation is a function of ambient temperature, the maximum allowable junction temperature and the thermal resistance from junction to air (i.e., T_A , T_J , θ_{JA}). Exceeding the maximum allowable power dissipation will cause the device operating junction temperature to exceed the maximum +150°C rating. Sustained junction temperatures above +150°C can impact the device reliability.

MIC2873

2.0 TYPICAL CHARACTERISTIC CURVES

Note: The graphs and tables provided following this note are a statistical summary based on a limited number of samples and are provided for informational purposes only. The performance characteristics listed herein are not tested or guaranteed. In some graphs or tables, the data presented may be outside the specified operating range (e.g., outside specified power supply range) and therefore outside the warranted range.

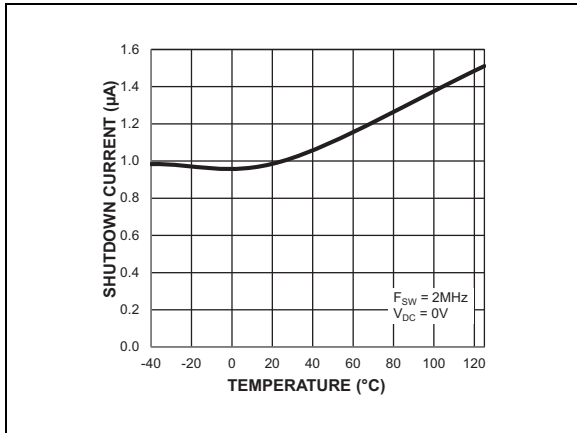

FIGURE 2-1: Shutdown Current vs. Temperature.

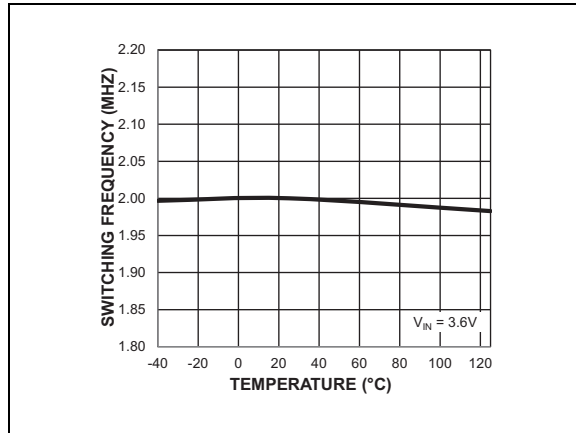

FIGURE 2-4: Switching Frequency vs. Temperature.

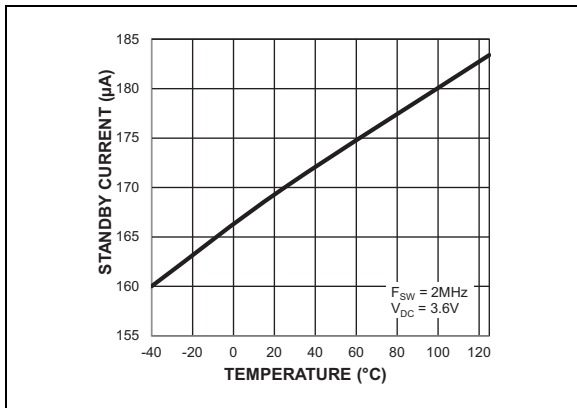

FIGURE 2-2: Standby Current vs. Temperature.

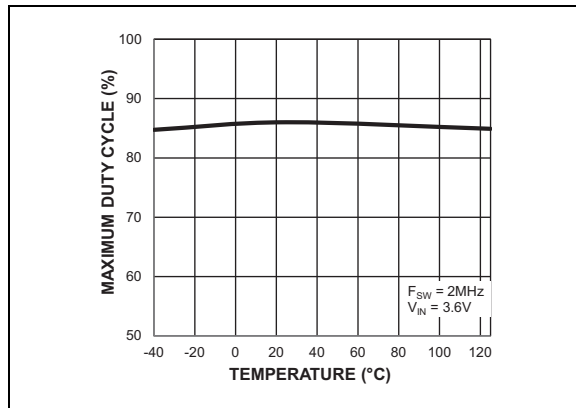

FIGURE 2-5: Maximum Duty Cycle vs. Temperature.

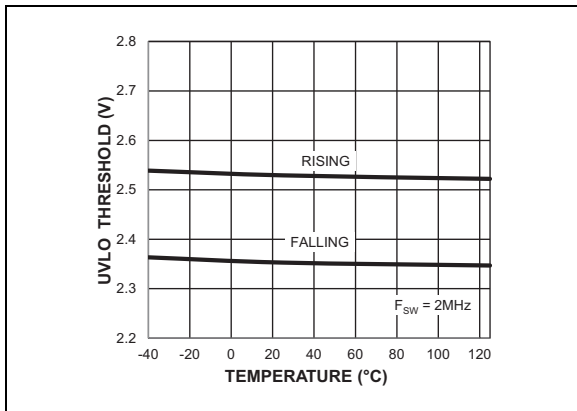

FIGURE 2-3: UVLO Threshold vs. Temperature.

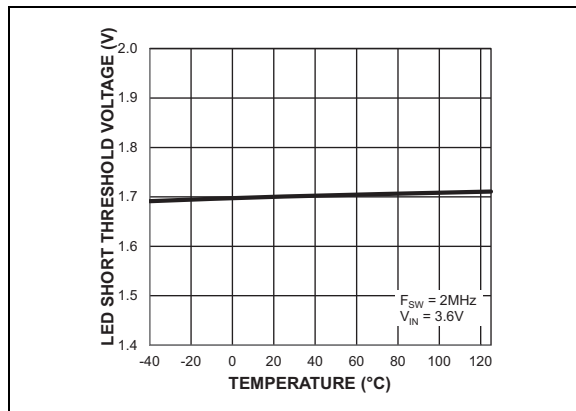

FIGURE 2-6: LED Short Threshold Voltage vs. Temperature.

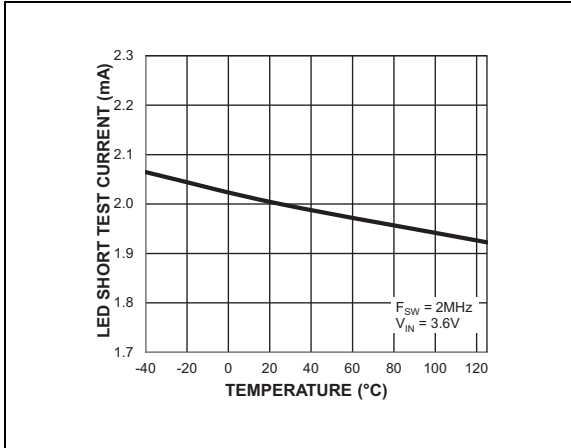

FIGURE 2-7: LED Short Test Current vs. Temperature.

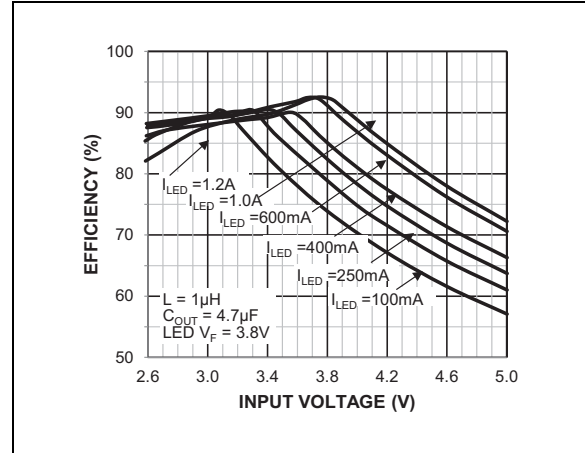

FIGURE 2-10: WLED Power Efficiency vs. Input Voltage ($V_F = 3.8V$).

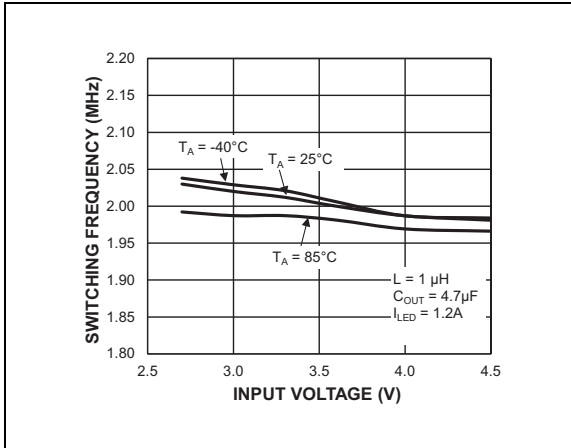

FIGURE 2-8: Boost Switching Frequency vs. Input Voltage.

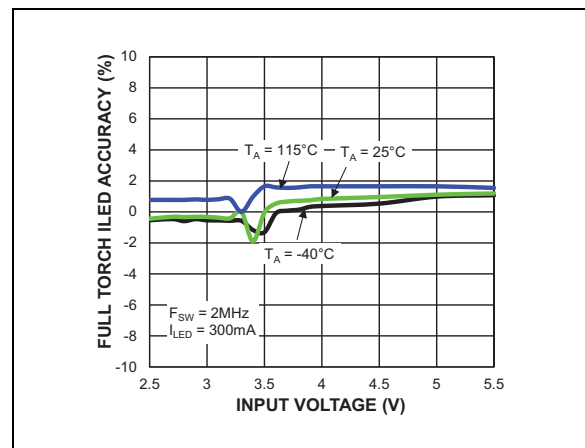

FIGURE 2-11: Full Torch ILED Accuracy vs. Input Voltage.

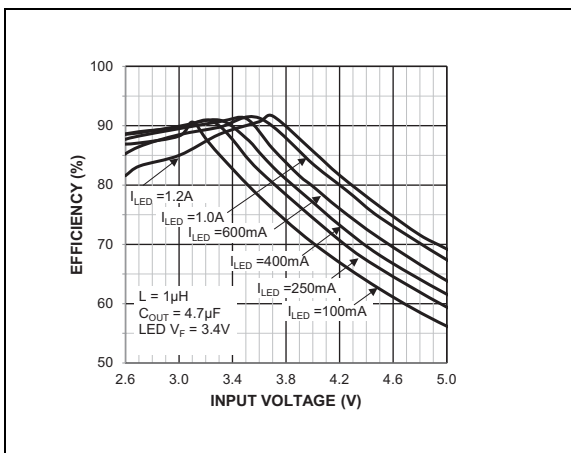

FIGURE 2-9: WLED Power Efficiency vs. Input Voltage ($V_F = 3.4V$).

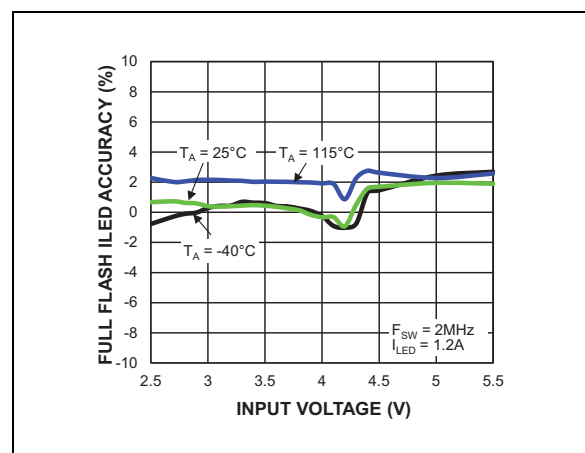

FIGURE 2-12: Full Flash ILED Accuracy vs. Input Voltage.

MIC2873

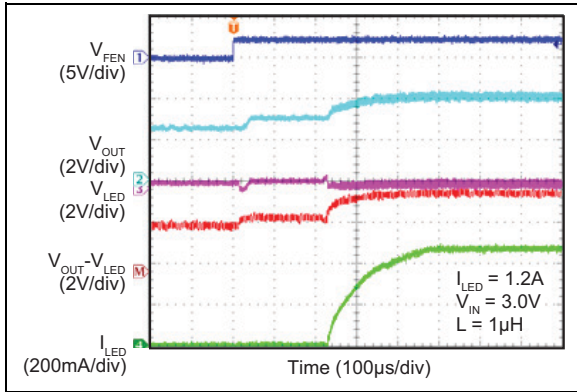

FIGURE 2-13: Flash Mode Turn-On Sequence (Boost Mode).

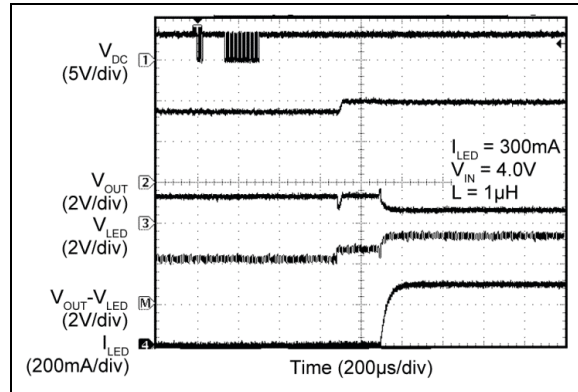

FIGURE 2-16: Torch Mode Turn-On Sequence (Linear Mode).

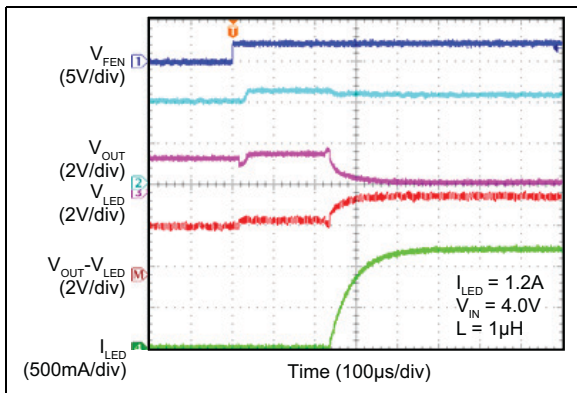

FIGURE 2-14: Flash Mode Turn-On Sequence (Linear Mode).

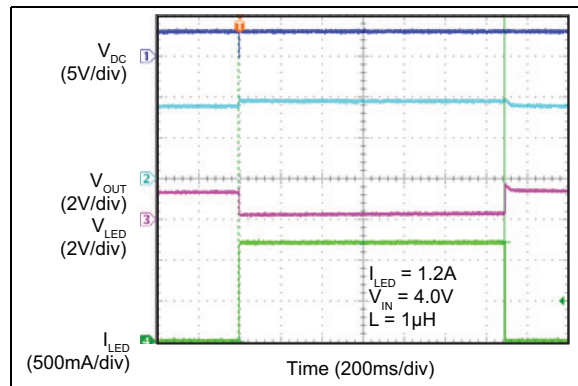

FIGURE 2-17: Flash Safety Timer at 1250 ms.

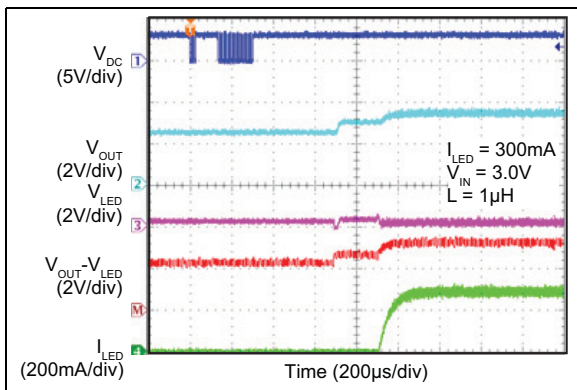

FIGURE 2-15: Torch Mode Turn-On Sequence (Boost Mode).

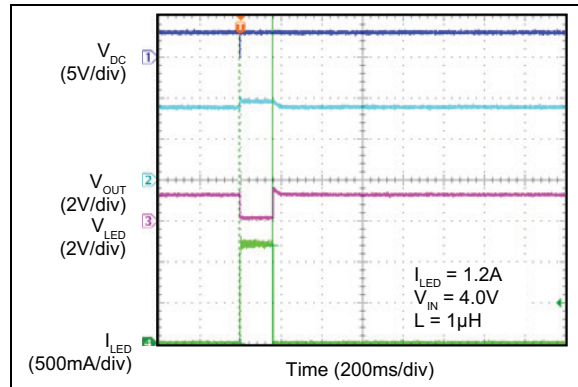

FIGURE 2-18: Flash Safety Timer at 156 ms.

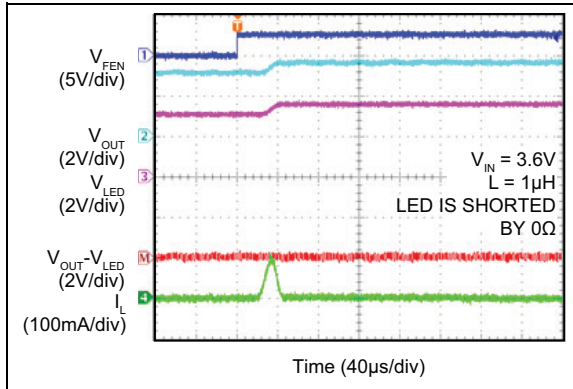

FIGURE 2-19: LED Short-Circuit Protection (LED is Shorted by 0Ω).

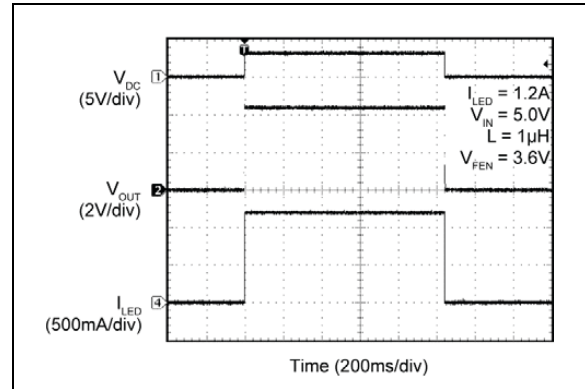

FIGURE 2-22: Load Disconnect at Shutdown ($V_{IN} = 5.0V$).

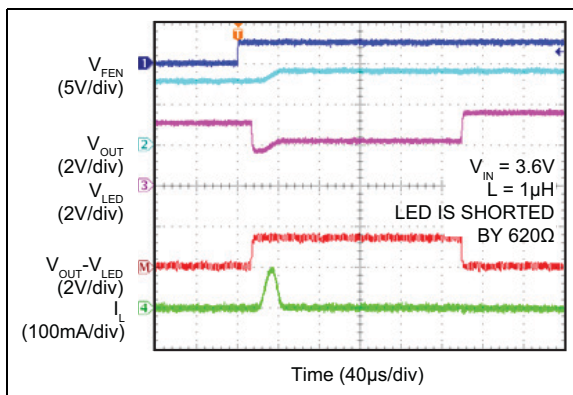

FIGURE 2-20: LED Short-Circuit Protection (LED is Shorted by 620Ω).

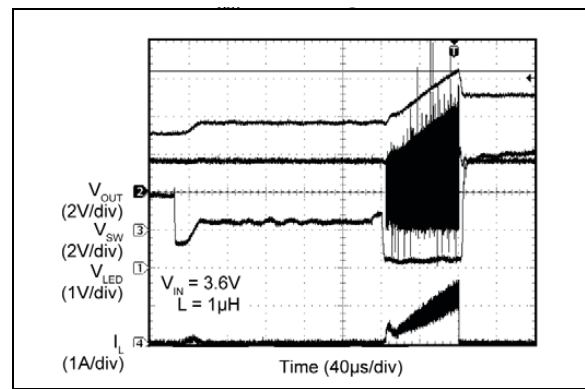

FIGURE 2-23: V_{OUT} Overvoltage Protection (Overvoltage during Start-up).

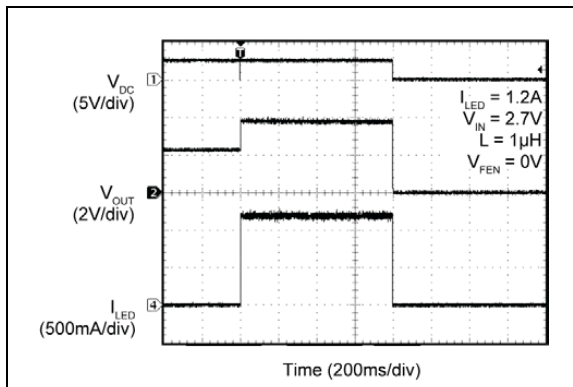

FIGURE 2-21: Load Disconnect at Shutdown ($V_{IN} = 2.7V$).

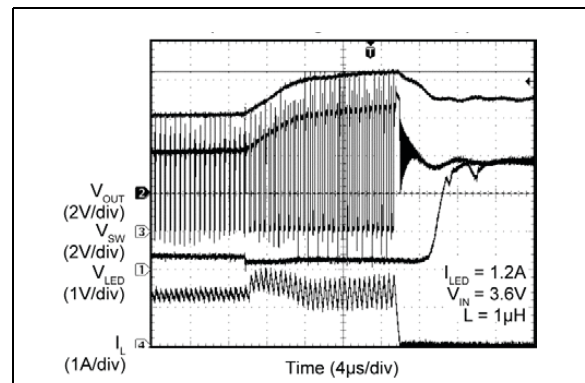

FIGURE 2-24: V_{OUT} Overvoltage Protection (Overvoltage after Start-up).

MIC2873

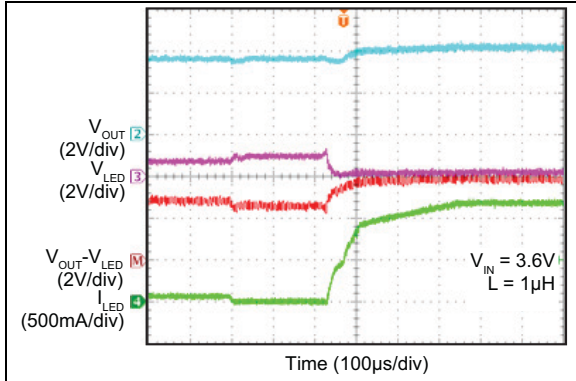

FIGURE 2-25: Load Transient (Torch 63 mA to Flash 1.2A).

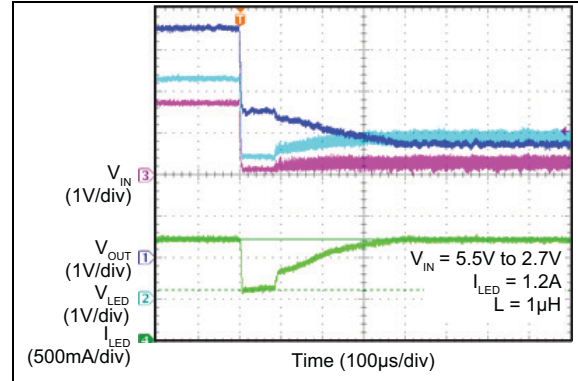

FIGURE 2-28: Line Transient (V_{IN} Changes from 5.5V to 2.7V).

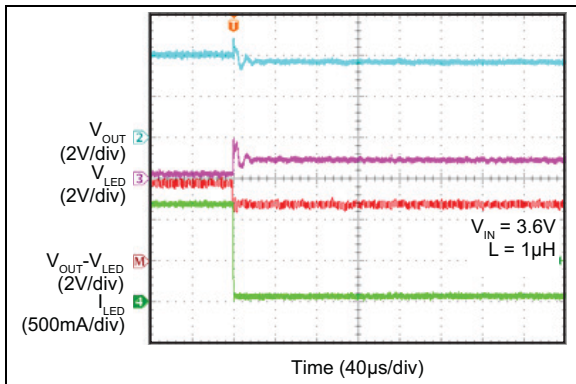

FIGURE 2-26: Load Transient (Flash 1.2A to Torch 63 mA).

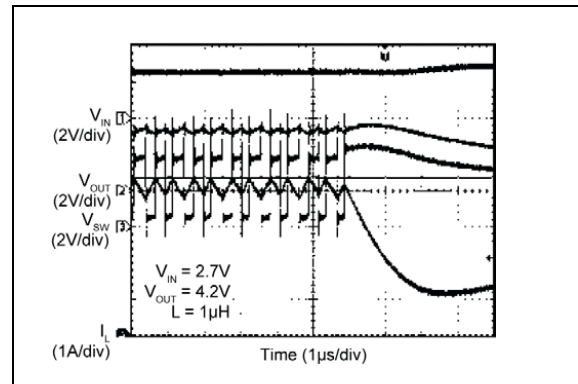

FIGURE 2-29: Switch Current Limit.

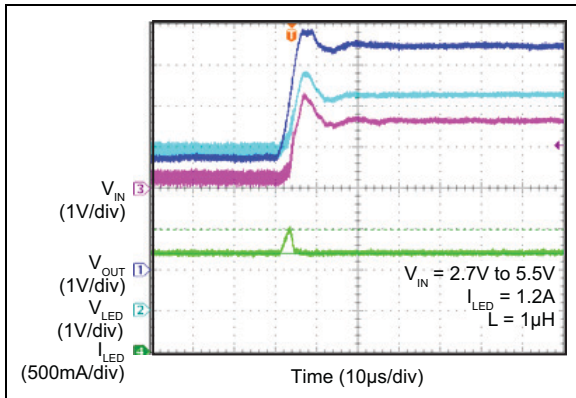

FIGURE 2-27: Line Transient (V_{IN} Changes from 2.7V to 5.5V).

3.0 PIN DESCRIPTIONS

The descriptions of the pins are listed in [Table 3-1](#).

TABLE 3-1: PIN FUNCTION TABLE

MIC2873 Pin Number	Pin Name	Pin Function
A1	LED	LED Current Sink Pin: Connect the LED anode to OUT and the cathode to this pin.
A2	DC	Single-Wire Interface: Serial control input.
A3	OUT	Boost Converter Output Pin: To be connected to the anode of the LED. Connect a low-ESR ceramic capacitor of at least 4.7 μ F at this pin to PGND.
B1	LGND	Linear Ground: LED current return path.
B2	FEN	Flash Mode Enable Pin: Asserting this pin high enables the MIC2873 to enter Flash mode. If this pin is left floating, it is pulled down internally by a built-in 1 μ A current source when the device is enabled.
B3	SW	Inductor Connection Pin: It is connected to the internal power MOSFETs.
C1	AGND	Analog Ground.
C2	VIN	Supply Input Pin: Connect a low-ESR ceramic capacitor of at least 4.7 μ F at this pin to AGND.
C3	PGND	Power Ground: Inductor current return path.

MIC2873

4.0 FUNCTIONAL DESCRIPTION

4.1 V_{IN}

The input supply provides power to the internal MOSFETs' gate drive and controls circuitry for the Switch mode regulator. The operating input voltage range is from 2.7V to 5.5V. A 4.7 μ F low-ESR ceramic input capacitor should be connected from V_{IN} to AGND, as close to MIC2873 as possible, to ensure a clean supply voltage for the device. The minimum voltage rating of 10V is recommended for the input capacitor.

4.2 SW

The MIC2873 has internal low-side and synchronous MOSFET switches. The switch node (SW) between the internal MOSFET switches connects directly to one end of the inductor and provides the current paths during switching cycles.

The other end of the inductor is connected to the input supply voltage. Due to the high-speed switching on this pin, the switch node should be routed away from sensitive nodes wherever possible.

4.3 LGND

This is the ground path of the LED current sink. It should be connected to the AGND on the PCB. The current loop of the Analog Ground should be separated from that of the Power Ground (PGND). LGND and AGND should be connected to PGND at a single point.

4.4 AGND

This is the ground path for the internal biasing and control circuitry. AGND should be connected to the LGND directly. The current loop of the Analog Ground should be separated from that of the Power Ground (PGND). The AGND and LGND should be connected to PGND at a single point.

4.5 PGND

The Power Ground pin is the ground path for the high current in the boost switch. The current loop for the Power Ground should be as small as possible and separate from the Analog Ground (AGND) loop as applicable.

4.6 OUT

This is the boost converter output pin, which is connected to the anode of the LED. A low-ESR ceramic capacitor of 4.7 μ F or larger should be connected from OUT to PGND, as close as possible to the MIC2873. The minimum voltage rating of 10V is recommended for the output capacitor.

4.7 LED

This is the current sink pin for the LED. The LED anode is connected to the OUT pin and the LED cathode is connected to this pin.

4.8 DC

The DC is a single multiplexed device enable and serial data control pin used for functional control, and communication in GPIO limited applications. When the DC pin is used as a hardware device enable pin, a logic high signal on the DC pin enables the device and a logic low signal on the DC pin disables the device. When the DC pin is used as the single-wire serial interface Digital Control pin, a combination of bit edges and the period between edges is used to communicate a variable length data word across the single wire. Each word is transmitted as a series of pulses, with each pulse incrementing an internal data counter. A stop sequence, consisting of an inactive period, is used to latch the data word internally. Two data words in series received are then used to set a specific register with a specific value for controlling a specific function. The MIC2873 supports five writable registers for controlling Flash mode, Torch mode, safety timer duration, safety timer threshold current and low-battery threshold.

An address/data frame is used to improve protection against erroneous writes where communications are in error. When the DC is in a low state, and no data is detected for longer than 405 μ s, the MIC2873 will automatically go into a low-power Shutdown state, simultaneously resetting all internal registers to their default states.

4.9 FEN

FEN is the hardware enable pin for Flash mode. A logic low-to-high transition on the FEN pin can initiate the MIC2873 in Flash mode. If FEN is left floating, it is pulled down internally by a built-in 1 μ A current source when the device is enabled. Flash mode is terminated when FEN is pulled low or left floating and the Flash register is cleared.

5.0 APPLICATION INFORMATION

The MIC2873 can drive a high-current Flash WLED in either Flash mode or Torch mode.

5.1 Boost Converter

The internal boost converter is turned on/off automatically when the LED driver is activated/deactivated without any exception.

The boost converter is an internally compensated Current mode PWM boost converter running at 2 MHz. It is for stepping up the supply voltage to a high enough value at the OUT pin to drive the LED current. If the supply voltage is high enough, the synchronous switch of the converter is then fully turned on. In this case, all the excessive voltage is dropped over the linear LED driver.

5.2 Flash Mode

The maximum and default current levels in the Flash mode are 1.2A and 1A respectively. The Flash mode current can be initiated by asserting the FEN pin high or by setting the Flash Control register (Address 1) for the desired Flash duration, subjected to the safety time-out setting. The Flash mode current is terminated when the FEN pin is brought low and the Flash register is cleared or when the configurable safety timer expires.

Flash mode current can be adjusted to a fraction of the maximum Flash mode current level by selecting the desired value in the Flash Control register through the single-wire serial interface.

5.3 Torch Mode

The default Torch mode current level is 250 mA and the Torch mode current level can be set to 300 mA at the maximum. The Torch mode operation is activated by setting the Torch Control register (Address 2) for the desired duration. The Torch mode current is terminated when the Torch register is cleared or when the configurable safety timer expires.

Like the Flash mode current, the Torch mode current can be set to a fraction of the maximum Torch mode current level by selecting the desired torch current in the Torch Control register (Address 2) via the single-wire serial interface.

5.4 Configurable Safety Timer

The Flash safety time-out feature automatically shuts down the LED current, after the safety timer duration is expired, if the programmed LED current exceeds a certain current threshold. Both the current threshold and the timer duration are programmable via the Safety Timer registers (Addresses 3 and 5).

5.5 Low-Battery Voltage Detection (LBVD)

When the V_{IN} voltage drops below the LBVD threshold (default = 3.0V) in Flash or Torch mode, the LED current driver is disabled. The LED driver can be resumed by raising the V_{IN} above the LBVD threshold and toggling the corresponding Flash or torch command. The LBVD threshold is adjustable through the LBVD Control register (Address 4).

5.6 Overvoltage Protection

When the output voltage rises above an internal overvoltage protection (OVP) threshold, MIC2873 is latched off automatically to avoid permanent damage to the IC. To clear the latched off condition, either power cycle the MIC2873 or assert the DC pin low.

5.7 Short-Circuit Detection

Each time, before enabling the LED driver, the MIC2873 performs the short-circuit test by driving the Flash LED with a small (2 mA typical) current for 200 μ s. If $(V_{OUT} - V_{LED})$ is less than 1.7V at the end of the short-circuit test, then the LED is considered to be shorted and MIC2873 will ignore the Flash and/or Torch mode command. Note that the short-circuit test is carried out every time, prior to Flash and Torch mode, but the result is not latched.

5.8 Thermal Shutdown

When the internal die temperature of MIC2873 reaches 155°C, the LED driver is disabled until the die temperature falls below 140°C and either the FEN pin, FEN register, TEN register or V_{IN} is toggled.

5.9 Single-Wire Interface

The single-wire interface allows the use of a single multiplexed enable and data pin (DC) for control and communication in GPIO limited applications. The interface is implemented using a simple mechanism, allowing any open-drain or directly driven GPIO to control the MIC2873.

The MIC2873 uses the single-wire interface for simple command and control functions. The interface provides fast access to write-only registers with protection features to avoid potentially erroneous data writes and improve robustness. When the DC is in a low state and no data is detected for longer than 405 μ s, the MIC2873 will automatically go into a low-power Shutdown state, simultaneously resetting the internal registers to their default states.

After receiving the stop sequence, the internal registers' decode and update cycle is started, with the Shadow register values being transferred to the decoder. Figure 5-3 shows an example of entering a write of Data 5 to Address 3.

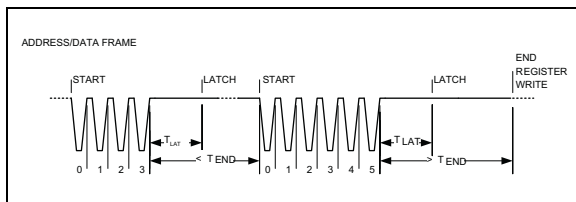

FIGURE 5-3: Communication Timing
Example of Entering Write for Data 5 to Address 3.

Only a correctly formatted address/data combination will be treated as a valid frame and processed by the MIC2873. Any other input, such as a single data word followed by T_{END} or three successive data words, will be discarded by the target hardware as an erroneous entry. Additionally, any register write to either an invalid register or with invalid register data will also be discarded.

5.13 MIC2873 Registers

The MIC2873 supports five writable registers for controlling the Torch and the Flash modes of operation, as shown in Table 5-2. Note that register addressing starts at 1. Writing any value above the maximum value shown for each register will cause an invalid data error and the frame will be discarded.

TABLE 5-2: FIVE WRITABLE REGISTERS OF MIC2873

Address	Name	Max. Value	Description
1	FEN/FCUR	31	Flash Enable/Current
2	TEN/TCUR	31	Torch Enable/Current
3	STDUR	7	Safety Timer Duration
4	LB_TH	9	Low-Battery Voltage Detection Threshold
5	ST_TH	5	Safety Timer Threshold

5.13.1 FLASH CURRENT REGISTER (FEN/FCUR: DEFAULT 4)

The Flash Current register enables and sets the Flash mode current level. Valid values are 0 to 31. Values 0-15 will set the Flash current without enabling the Flash (such that it can be triggered externally). Values 16-31 will set the Flash current and enable the Flash. The Flash current register maps into the internal FEN and FCUR registers, as shown in the following table below. Table 5-3 describes the relationship between the Flash current and the FCUR register setting.

TABLE 5-3: FLASH CURRENT REGISTER MAPPING INTO INTERNAL FEN/FCUR REGISTERS AND RELATIONSHIP BETWEEN FLASH CURRENT AND FCUR REGISTER SETTING

Dec.	Binary	FEN/FCUR<4:0> Value		I_{FLASH} (A)
		FEN<4>	FCUR<3:0>	
0	00000	0	0000	1.200
1	00001	0	0001	1.150
2	00010	0	0010	1.100
3	00011	0	0011	1.050
4	00100	0	0100	1.000
5	00101	0	0101	0.950
6	00110	0	0110	0.900
7	00111	0	0111	0.850
8	01000	0	1000	0.800
9	01001	0	1001	0.750
10	01010	0	1010	0.700
11	01011	0	1011	0.650
12	01100	0	1100	0.600
13	01101	0	1101	0.550
14	01110	0	1110	0.400
15	01111	0	1111	0.250
16	10000	1	0000	1.200
17	10001	1	0001	1.150
18	10010	1	0010	1.100
19	10011	1	0011	1.050
20	10100	1	0100	1.000
21	10101	1	0101	0.950
22	10110	1	0110	0.900
23	10111	1	0111	0.850
24	11000	1	1000	0.800
25	11001	1	1001	0.750
26	11010	1	1010	0.700
27	11011	1	1011	0.650
28	11100	1	1100	0.600
29	11101	1	1101	0.550
30	11110	1	1110	0.400
31	11111	1	1111	0.250

5.13.2 TORCH CURRENT REGISTER (TEN/TCUR: DEFAULT 4)

The Torch Current register enables and sets the Torch mode current level. Valid values are 0 to 31. Values 0-15 will set the torch current without enabling the torch (such that it can be triggered by setting the internal TEN register value to 1). Values 16-31 will set the torch current and enable the torch. A value of 0 at the internal TEN register will disable the torch. The Torch Current register maps into the internal TEN and TCUR registers, as shown in [Table 5-4](#). The table also describes the relationship between the torch current and the TCUR register setting.

TABLE 5-4: TORCH CURRENT REGISTER MAPPING INTO INTERNAL TEN/TCUR REGISTERS AND RELATIONSHIP BETWEEN TORCH CURRENT AND TCUR REGISTER SETTING

TEN/TCUR<4:0> Value				I _{TORCH} (mA)
Dec.	Binary	TEN<4>	TCUR<3:0>	
0	00000	0	0000	300.0
1	00001	0	0001	287.5
2	00010	0	0010	275.0
3	00011	0	0011	262.5
4	00100	0	0100	250.0
5	00101	0	0101	237.5
6	00110	0	0110	225.0
7	00111	0	0111	212.5
8	01000	0	1000	200.0
9	01001	0	1001	187.5
10	01010	0	1010	175.0
11	01011	0	1011	162.5
12	01100	0	1100	150.0
13	01101	0	1101	137.5
14	01110	0	1110	100.0
15	01111	0	1111	62.5
16	10000	1	0000	300.0
17	10001	1	0001	287.5
18	10010	1	0010	275.0
19	10011	1	0011	262.5
20	10100	1	0100	250.0
21	10101	1	0101	237.5
22	10110	1	0110	225.0
23	10111	1	0111	212.5
24	11000	1	1000	200.0
25	11001	1	1001	187.5
26	11010	1	1010	175.0
27	11011	1	1011	162.5
28	11100	1	1100	150.0
29	11101	1	1101	137.5
30	11110	1	1110	100.0
31	11111	1	1111	62.5

5.13.3 SAFETY TIMER DURATION REGISTER (STDUR: DEFAULT 7)

The Safety Timer Duration register sets the duration of the Flash and Torch mode when the LED current exceeds the programmed threshold current. Valid values are 0 for the minimum timer duration to 7 for the maximum duration.

TABLE 5-5: SAFETY TIMER DURATION REGISTER SETTING AND SAFETY TIMER DURATION

Value		STDUR<2:0> (Binary)	Time-out (ms)
Dec.	Binary		
0	000	000	156.25
1	001	001	312.5
2	010	010	468.75
3	011	011	625
4	100	100	781.25
5	101	101	937.5
6	110	110	1093.75
7	111	111	1250

5.13.4 LOW-BATTERY THRESHOLD REGISTER (LB_TH: DEFAULT 1)

The LB_TH register sets the supply threshold voltage, below which the internal low-battery flag is asserted and the LED current driver is disabled. [Table 5-6](#) shows the threshold values that correspond to the register settings. Setting 0 is reserved for disabling the function, and settings between 1 and 9 inclusively enable and set the LB_TH value, between 3.0V and 3.8V, with 100 mV resolution.

TABLE 5-6: LOW-BATTERY THRESHOLD REGISTER SETTING AND SUPPLY THRESHOLD VOLTAGE

Value		LB_TH<3:0>	V _{BAT} Threshold (V)
Dec.	Binary		
0	0000	0000	Disabled
1	0001	0001	3.0
2	0010	0010	3.1
3	0011	0011	3.2
4	0100	0100	3.3
5	0101	0101	3.4
6	0110	0110	3.5
7	0111	0111	3.6
8	1000	1000	3.7
9	1001	1001	3.8

5.13.5 SAFETY TIMER THRESHOLD CURRENT REGISTER (ST_TH: DEFAULT 4)

The Safety Timer Threshold Current register determines the amount of LED current flowing through the external LED before the internal LED safety timer is activated. Setting ST_TH to 0 disables the safety timer function, and setting the register to Values 1-5 sets the safety timer threshold current to 100 mA to 300 mA in 50 mA steps.

TABLE 5-7: SAFETY TIMER THRESHOLD CURRENT REGISTER SETTING AND SAFETY TIMER THRESHOLD CURRENT

Value		ST_TH<2:0>	Safety Timer Threshold Current (mA)
Dec.	Binary		
0	000	000	Disabled
1	001	001	100
2	010	010	150
3	011	011	200
4	100	100	250
5	101	101	300

6.0 COMPONENT SELECTION

6.1 Inductor

Inductor selection should strike a balance between efficiency, stability, cost, size, and rated current. Because the boost converter is compensated internally, the recommended inductance of L is limited from 1 μ H to 2.2 μ H to ensure system stability, and a 1 μ H inductor is typically recommended. It is usually a good balance between these considerations.

A large inductance value reduces the peak-to-peak inductor ripple current, hence the output ripple voltage and the LED ripple current. This also reduces both the DC loss and the transition loss at the same inductor's DC Resistance (DCR). However, the DCR of an inductor usually increases with the inductance in the same package size. This is due to the longer windings required for an increase in inductance. Because the majority of the input current passes through the inductor, the higher the DCR, the lower the efficiency is, and more significantly, at higher load currents. On the other hand, an inductor with a smaller DCR, but the same inductance, usually has a larger size. The saturation current rating of the selected inductor must be higher than the maximum peak inductor current to be encountered and should be at least 20% to 30% higher than the average inductor current at maximum output current.

6.2 Input Capacitor

A ceramic capacitor of 4.7 μ F or larger with low-ESR is recommended to reduce the input voltage ripple to ensure a clean supply voltage for the device. The input capacitor should be placed as close as possible to the MIC2873 V_{IN} pin with a short trace for good noise performance. X5R or X7R type ceramic capacitors are recommended for better tolerance over temperature. The Y5V and Z5U type temperature rating ceramic capacitors are not recommended due to their large reduction in capacitance over temperature and increased resistance at high frequencies. These reduce their ability to filter out high-frequency noise. The rated voltage of the input capacitor should be at least 20% higher than the maximum operating input voltage over the operating temperature range.

6.3 Output Capacitor

Output capacitor selection is also a trade-off between performance, size and cost. Increasing output capacitance will lead to an improved transient response; however, the size and cost also increase. The output capacitor is preferred in the range of 2.2 μ F to 10 μ F with ESR from 10 m Ω to 50 m Ω , and a 4.7 μ F ceramic capacitor is typically recommended. X5R or X7R type ceramic capacitors are recommended for better tolerance over temperature. The Y5V and Z5U type ceramic capacitors are not recommended due to their wide variation in capacitance over temperature and increased resistance at high frequencies. The rated voltage of the output capacitor should be at least 20% higher than the maximum operating output voltage over the operating temperature range.

7.0 POWER DISSIPATION CONSIDERATION

As with all power devices, the ultimate current rating of the output is limited by the thermal properties of the device package and the PCB on which the device is mounted. There is a simple Ohm's law type relationship between thermal resistance, power dissipation and temperature, which are analogous to an electrical circuit:

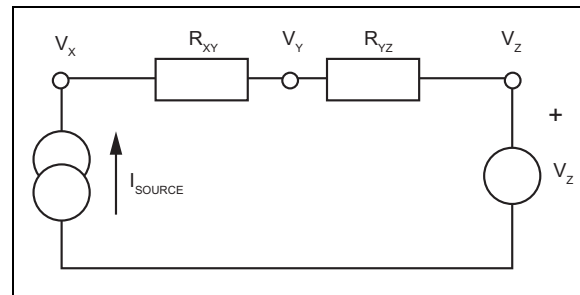

FIGURE 7-1: Series Electrical Resistance Circuit.

From this simple circuit, we can calculate V_X if we know I_{SOURCE} , V_Z and the resistor values, R_{XY} and R_{YZ} , using [Equation 7-1](#):

EQUATION 7-1: CALCULATING V_X

$$V_X = I_{SOURCE} \times (R_{XY} + R_{YZ}) = V_Z$$

Thermal circuits can be considered using this same rule and can be drawn similarly by replacing current sources with power dissipation (in watts), resistance with thermal resistance (in °C/W) and voltage sources with temperature (in °C).

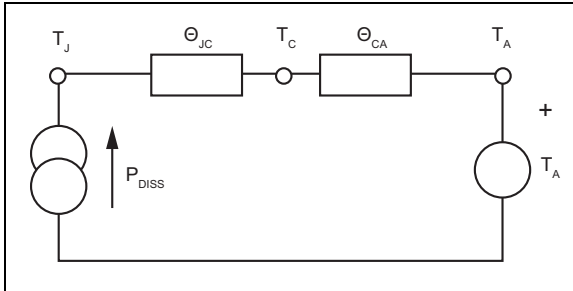

FIGURE 7-2: Series Thermal Resistance Circuit.

Now replacing the variables in the equation for V_X , we can find the Junction Temperature (T_J) from the power dissipation, ambient temperature and the known thermal resistance of the PCB (θ_{CA}) and the package (θ_{JC}).

EQUATION 7-2: CALCULATING JUNCTION TEMPERATURE

$$T_J = P_{DISS} \times (\theta_{JC} + \theta_{CA}) + T_A$$

As seen in [Figure 7-2](#), the total thermal resistance is: $\theta_{JA} = \theta_{JC} + \theta_{CA}$. Hence, this can also be written as [Equation 7-3](#):

EQUATION 7-3: CALCULATING THERMAL RESISTANCE

$$T_J = P_{DISS} \times (\theta_{JA}) + T_A$$

Where:
 θ_{JA} = Thermal resistance between junction and ambient, which is typically 84°C/W for 1.3 mm x 1.3 mm WLCSP package

Since effectively all of the power losses (minus the inductor losses) in the converter are dissipated within the MIC2873 package, P_{DISS} can be calculated thus:

EQUATION 7-4: CALCULATING P_{DISS}

Linear Mode:

$$P_{DISS} = [P_{OUT} \times \left(\frac{1}{\eta} - 1\right)] - I_{OUT}^2 \times DCR$$

Boost Mode:

$$P_{DISS} = [P_{OUT} \times \left(\frac{1}{\eta} - 1\right)] - \left(\frac{I_{OUT}}{1-D}\right)^2 \times DCR$$

Duty Cycle in Boost Mode:

$$D = \frac{V_{OUT} - V_{IN}}{V_{OUT}}$$

Where:
 η = Efficiency taken from efficiency curves
 DCR = Inductor DCR

Where the real board area differs from 1 inch square, θ_{CA} (the PCB thermal resistance) values for various PCB copper areas can be taken from [Figure 7-3](#). [Figure 7-3](#) is taken from “*Designing with Low Dropout Voltage Regulators*” available from the Microchip web site (“[LDO Application Hints](#)”).

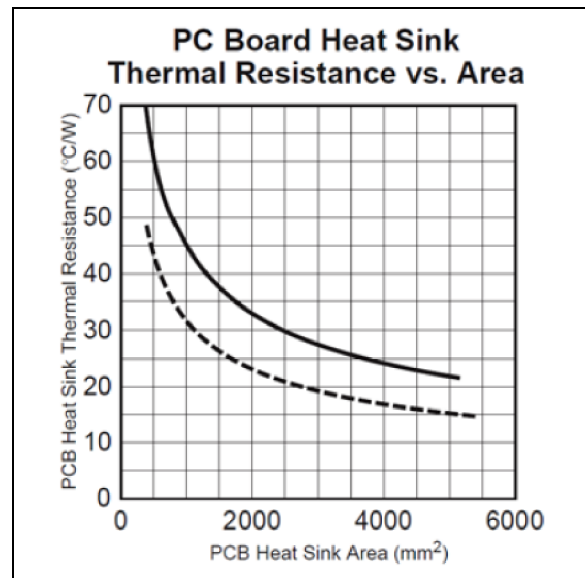

FIGURE 7-3: Graph to Determine PC Board Area for a Given PCB Thermal Resistance.

[Figure 7-3](#) shows the total area of a round or square pad, centered on the device. The solid trace represents the area of a square, single-sided, horizontal orientation, solder masked, copper PC board trace heat sink, measured in square millimeters. No airflow is assumed. The dashed line shows the PC board's trace heat sink covered in black oil-based paint and with 1.3m/sec (250 feet per minute) airflow. This approaches a “best case” pad heat sink. Conservative design dictates using the solid trace data, which indicates that a maximum pad size of 5000 mm² is needed. This is a pad that is 71 mm by 71 mm (2.8 inches per side).

8.0 PCB LAYOUT GUIDELINES

PCB layout is critical to achieve reliable, stable and efficient performance. A ground plane is required to control EMI and minimize the inductance in power and signal return paths. The following guidelines should be followed to ensure proper operation of the device.

8.1 IC (Integrated Circuit)

- Place the IC close to the point-of-load (in this case, the flash LED).
- Use fat traces to route the input and output power lines.
- Analog grounds (LGND and AGND) and power ground (PGND) should be kept separate and connected at a single location.
- 6 to 12 thermal vias must be placed on the PCB top layer PGND copper from the PGND pin and connected it to the ground plane to ensure a good PCB thermal resistance can be achieved.
- Since all the top copper areas connected directly to the CSP package bumps are used as the immediate PCB heat sink, these top copper areas should be spread out from the bumps in funnel-shape to maximize the top copper PCB heat sink areas.

8.2 VIN Decoupling Capacitor

- The VIN decoupling capacitor must be placed close to the VIN pin of the IC and preferably connected directly to the pin and not through any via. The capacitor must be located right at the IC.
- The VIN decoupling capacitor should be connected to analog ground (AGND).
- The VIN terminal is noise sensitive and the placement of capacitor is very critical.

8.3 Inductor

- Keep both the inductor connections to the switch node (SW) and input power line short and wide enough to handle the switching current. Keep the areas of the switching current loops small to minimize the EMI problem.
- Do not route any digital lines underneath or close to the inductor.
- Keep the switch node (SW) away from the noise sensitive pins.
- To minimize noise, place a ground plane underneath the inductor.

8.4 Output Capacitor

- The output capacitor must be placed close to the OUT pin and PGND pin of the IC and preferably connected directly and closely to the OUT pin and PGND pin without going through any via to minimize the switching current loop during the main switch off-cycle, and the switching noise.
- Use wide and short traces to connect the output capacitor to the OUT and PGND pins.
- Place several vias to the ground plane close to the output capacitor ground terminal.
- Use either X5R or X7R temperature rating ceramic capacitors. Do not use Y5V or Z5U type ceramic capacitors.

8.5 Flash LED

- Use wide and short trace to connect the LED anode to the OUT pin.
- Use wide and short trace to connect the LED cathode to the LED pin.
- Make sure that the LED's PCB land pattern can provide sufficient PCB pad heat sink to the flash LED, such as sufficient copper areas and thermal vias.

9.0 PACKAGING INFORMATION

9.1 Package Marking Information

9-Bump WLCSP*

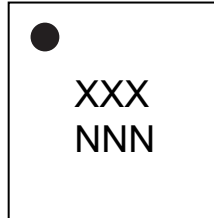

Example

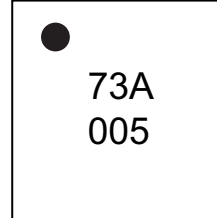

Legend:	XX...X	Product code or customer-specific information
	Y	Year code (last digit of calendar year)
	YY	Year code (last 2 digits of calendar year)
	WW	Week code (week of January 1 is week '01')
	NNN	Alphanumeric traceability code
	(e3)	Pb-free JEDEC® designator for Matte Tin (Sn)
	*	This package is Pb-free. The Pb-free JEDEC designator ((e3)) can be found on the outer packaging for this package.
	•, ▲, ▼	Pin one index is identified by a dot, delta up or delta down (triangle mark).
Note:	In the event the full Microchip part number cannot be marked on one line, it will be carried over to the next line, thus limiting the number of available characters for customer-specific information. Package may or may not include the corporate logo.	
	Underbar (¯) and/or Overbar (¯) symbol may not be to scale.	

MIC2873

9-Ball WLCSP Package Outline and Recommended Land Pattern

TITLE

9 BALL WLCSP 1.3x1.3mm PACKAGE OUTLINE & RECOMMENDED LAND PATTERN

DRAWING #	WLCSP1313Q-9BL-PL-9	UNIT	MM
------------------	---------------------	-------------	----

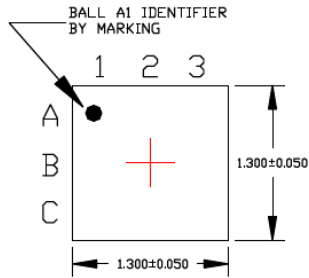

TOP VIEW

NOTE: 1,2

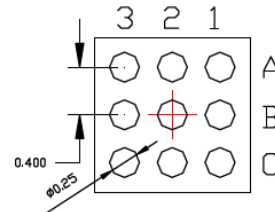

BOTTOM VIEW

NOTE: 1,2

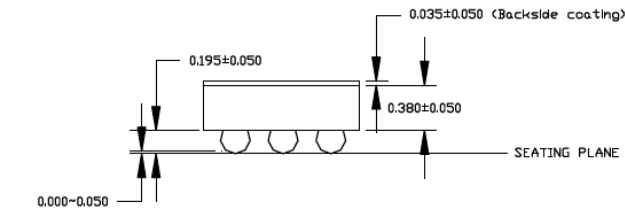

SIDE VIEW

NOTE: 1,2

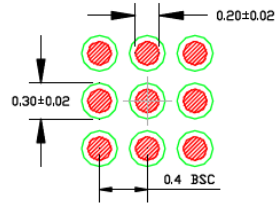

RECOMMENDED LAND PATTERN

NOTE: 3,4

NOTE:

1. MAX PACKAGE WARPAGE IS 0.05 MM
2. MAX ALLOWABLE BURR IS 0.076MM IN ALL DIRECTIONS
3. NON-SOLDERMASK DEFINED PADS ARE RECOMMENDED FOR BOARD LAYOUT
4. SHADED RED CIRCLES REPRESENT CONTACT PAD AREA. GREEN CIRCLES REPRESENT SOLDER MASK OPENING

Note: For the most current package drawings, please see the Microchip Packaging Specification located at <http://www.microchip.com/packaging>.

APPENDIX A: REVISION HISTORY

Revision A (October 2020)

- Converted Micrel document MIC2873 to Microchip data sheet DS20006435A.
- Minor text changes throughout document.

MIC2873

NOTES:

PRODUCT IDENTIFICATION SYSTEM

To order or obtain information, e.g., on pricing or delivery, contact your local Microchip representative or sales office.

<u>PART NO.</u>	X	XX	-	X
Device	Temperature	Package		Media Type
Device:	MIC2873:	1.2A High-Brightness Flash LED Driver with Single-Wire Serial Interface		
Temperature:	Y =	-40°C to +125°C		
Package:	CS =	9-bump 1.30 mm x 1.30 mm WLCSP		
Media Type:	TR =	3,000/Reel		

Examples:

a) MIC2873YCS-TR: MIC2873, -40°C to +125°C Temp. Range, 9-Bump WLCSP, 3,000/Reel

Note 1: Tape and Reel identifier only appears in the catalog part number description. This identifier is used for ordering purposes and is not printed on the device package. Check with your Microchip Sales Office for package availability with the Tape and Reel option.

MIC2873

NOTES:

Note the following details of the code protection feature on Microchip devices:

- Microchip products meet the specifications contained in their particular Microchip Data Sheet.
- Microchip believes that its family of products is secure when used in the intended manner and under normal conditions.
- There are dishonest and possibly illegal methods being used in attempts to breach the code protection features of the Microchip devices. We believe that these methods require using the Microchip products in a manner outside the operating specifications contained in Microchip's Data Sheets. Attempts to breach these code protection features, most likely, cannot be accomplished without violating Microchip's intellectual property rights.
- Microchip is willing to work with any customer who is concerned about the integrity of its code.
- Neither Microchip nor any other semiconductor manufacturer can guarantee the security of its code. Code protection does not mean that we are guaranteeing the product is "unbreakable." Code protection is constantly evolving. We at Microchip are committed to continuously improving the code protection features of our products. Attempts to break Microchip's code protection feature may be a violation of the Digital Millennium Copyright Act. If such acts allow unauthorized access to your software or other copyrighted work, you may have a right to sue for relief under that Act.

Information contained in this publication is provided for the sole purpose of designing with and using Microchip products. Information regarding device applications and the like is provided only for your convenience and may be superseded by updates. It is your responsibility to ensure that your application meets with your specifications.

THIS INFORMATION IS PROVIDED BY MICROCHIP "AS IS". MICROCHIP MAKES NO REPRESENTATIONS OR WARRANTIES OF ANY KIND WHETHER EXPRESS OR IMPLIED, WRITTEN OR ORAL, STATUTORY OR OTHERWISE, RELATED TO THE INFORMATION INCLUDING BUT NOT LIMITED TO ANY IMPLIED WARRANTIES OF NON-INFRINGEMENT, MERCHANTABILITY, AND FITNESS FOR A PARTICULAR PURPOSE OR WARRANTIES RELATED TO ITS CONDITION, QUALITY, OR PERFORMANCE.

IN NO EVENT WILL MICROCHIP BE LIABLE FOR ANY INDIRECT, SPECIAL, PUNITIVE, INCIDENTAL OR CONSEQUENTIAL LOSS, DAMAGE, COST OR EXPENSE OF ANY KIND WHATSOEVER RELATED TO THE INFORMATION OR ITS USE, HOWEVER CAUSED, EVEN IF MICROCHIP HAS BEEN ADVISED OF THE POSSIBILITY OR THE DAMAGES ARE FORESEEABLE. TO THE FULLEST EXTENT ALLOWED BY LAW, MICROCHIP'S TOTAL LIABILITY ON ALL CLAIMS IN ANY WAY RELATED TO THE INFORMATION OR ITS USE WILL NOT EXCEED THE AMOUNT OF FEES, IF ANY, THAT YOU HAVE PAID DIRECTLY TO MICROCHIP FOR THE INFORMATION. Use of Microchip devices in life support and/or safety applications is entirely at the buyer's risk, and the buyer agrees to defend, indemnify and hold harmless Microchip from any and all damages, claims, suits, or expenses resulting from such use. No licenses are conveyed, implicitly or otherwise, under any Microchip intellectual property rights unless otherwise stated.

Trademarks

The Microchip name and logo, the Microchip logo, Adaptec, AnyRate, AVR, AVR logo, AVR Freaks, BesTime, BitCloud, chipKIT, chipKIT logo, CryptoMemory, CryptoRF, dsPIC, FlashFlex, flexPWR, HELDO, IGL00, JukeBlox, KeeLoq, Klear, LANCheck, LinkMD, maXStylus, maXTouch, MediaLB, megaAVR, Microsemi, Microsemi logo, MOST, MOST logo, MPLAB, OptoLyzr, PackeTime, PIC, picoPower, PICSTART, PIC32 logo, PolarFire, Prochip Designer, QTouch, SAM-BA, SenGenuity, SpyNIC, SST, SST Logo, SuperFlash, Symmetricom, SyncServer, Tachyon, TimeSource, tinyAVR, UNI/O, Vectron, and XMEGA are registered trademarks of Microchip Technology Incorporated in the U.S.A. and other countries.

AgileSwitch, APT, ClockWorks, The Embedded Control Solutions Company, EtherSynch, FlashTec, Hyper Speed Control, HyperLight Load, IntelliMOS, Libero, motorBench, mTouch, Powermite 3, Precision Edge, ProASIC, ProASIC Plus, ProASIC Plus logo, Quiet-Wire, SmartFusion, SyncWorld, Temux, TimeCesium, TimeHub, TimePictra, TimeProvider, WinPath, and ZL are registered trademarks of Microchip Technology Incorporated in the U.S.A.

Adjacent Key Suppression, AKS, Analog-for-the-Digital Age, Any Capacitor, AnyIn, AnyOut, Augmented Switching, BlueSky, BodyCom, CodeGuard, CryptoAuthentication, CryptoAutomotive, CryptoCompanion, CryptoController, dsPICDEM, dsPICDEM.net, Dynamic Average Matching, DAM, ECAN, Espresso T1S, EtherGREEN, IdealBridge, In-Circuit Serial Programming, ICSP, INICnet, Intelligent Paralleling, Inter-Chip Connectivity, JitterBlocker, maxCrypto, maxView, memBrain, Mindi, MiWi, MPASM, MPF, MPLAB Certified logo, MPLIB, MPLINK, MultiTRAK, NetDetach, Omniscient Code Generation, PICDEM, PICDEM.net, PICkit, PICtail, PowerSmart, PureSilicon, QMatrix, REAL ICE, Ripple Blocker, RTAX, RTG4, SAM-ICE, Serial Quad I/O, simpleMAP, SimpliPHY, SmartBuffer, SMART-I.S., storClad, SQI, SuperSwitcher, SuperSwitcher II, Switchtec, SynchroPHY, Total Endurance, TSHARC, USBCheck, VariSense, VectorBlox, VeriPHY, ViewSpan, WiperLock, XpressConnect, and ZENA are trademarks of Microchip Technology Incorporated in the U.S.A. and other countries.

SQTP is a service mark of Microchip Technology Incorporated in the U.S.A.

The Adaptec logo, Frequency on Demand, Silicon Storage Technology, and Symmcom are registered trademarks of Microchip Technology Inc. in other countries.

GestIC is a registered trademark of Microchip Technology Germany II GmbH & Co. KG, a subsidiary of Microchip Technology Inc., in other countries.

All other trademarks mentioned herein are property of their respective companies.

© 2020, Microchip Technology Incorporated, All Rights Reserved.

ISBN: 978-1-5224-6981-0

For information regarding Microchip's Quality Management Systems, please visit www.microchip.com/quality.



MICROCHIP

Worldwide Sales and Service

AMERICAS

Corporate Office
2355 West Chandler Blvd.
Chandler, AZ 85224-6199
Tel: 480-792-7200
Fax: 480-792-7277
Technical Support:
<http://www.microchip.com/support>
Web Address:
www.microchip.com

Atlanta

Duluth, GA
Tel: 678-957-9614
Fax: 678-957-1455

Austin, TX

Tel: 512-257-3370

Boston

Westborough, MA
Tel: 774-760-0087
Fax: 774-760-0088

Chicago

Itasca, IL
Tel: 630-285-0071
Fax: 630-285-0075

Dallas

Addison, TX
Tel: 972-818-7423
Fax: 972-818-2924

Detroit

Novi, MI
Tel: 248-848-4000

Houston, TX

Tel: 281-894-5983

Indianapolis

Noblesville, IN
Tel: 317-773-8323
Fax: 317-773-5453
Tel: 317-536-2380

Los Angeles

Mission Viejo, CA
Tel: 949-462-9523
Fax: 949-462-9608
Tel: 951-273-7800

Raleigh, NC

Tel: 919-844-7510

New York, NY

Tel: 631-435-6000

San Jose, CA

Tel: 408-735-9110
Tel: 408-436-4270

Canada - Toronto

Tel: 905-695-1980
Fax: 905-695-2078

ASIA/PACIFIC

Australia - Sydney
Tel: 61-2-9868-6733

China - Beijing
Tel: 86-10-8569-7000

China - Chengdu
Tel: 86-28-8665-5511

China - Chongqing
Tel: 86-23-8980-9588

China - Dongguan
Tel: 86-769-8702-9880

China - Guangzhou
Tel: 86-20-8755-8029

China - Hangzhou
Tel: 86-571-8792-8115

China - Hong Kong SAR
Tel: 852-2943-5100

China - Nanjing
Tel: 86-25-8473-2460

China - Qingdao
Tel: 86-532-8502-7355

China - Shanghai
Tel: 86-21-3326-8000

China - Shenyang
Tel: 86-24-2334-2829

China - Shenzhen
Tel: 86-755-8864-2200

China - Suzhou
Tel: 86-186-6233-1526

China - Wuhan
Tel: 86-27-5980-5300

China - Xian
Tel: 86-29-8833-7252

China - Xiamen
Tel: 86-592-2388138

China - Zhuhai
Tel: 86-756-3210040

ASIA/PACIFIC

India - Bangalore
Tel: 91-80-3090-4444

India - New Delhi
Tel: 91-11-4160-8631

India - Pune
Tel: 91-20-4121-0141

Japan - Osaka
Tel: 81-6-6152-7160

Japan - Tokyo
Tel: 81-3-6880-3770

Korea - Daegu
Tel: 82-53-744-4301

Korea - Seoul
Tel: 82-2-554-7200

Malaysia - Kuala Lumpur
Tel: 60-3-7651-7906

Malaysia - Penang
Tel: 60-4-227-8870

Philippines - Manila
Tel: 63-2-634-9065

Singapore
Tel: 65-6334-8870

Taiwan - Hsin Chu
Tel: 886-3-577-8366

Taiwan - Kaohsiung
Tel: 886-7-213-7830

Taiwan - Taipei
Tel: 886-2-2508-8600

Thailand - Bangkok
Tel: 66-2-694-1351

Vietnam - Ho Chi Minh
Tel: 84-28-5448-2100

EUROPE

Austria - Wels
Tel: 43-7242-2244-39
Fax: 43-7242-2244-393

Denmark - Copenhagen
Tel: 45-4485-5910
Fax: 45-4485-2829

Finland - Espoo
Tel: 358-9-4520-820

France - Paris
Tel: 33-1-69-53-63-20
Fax: 33-1-69-30-90-79

Germany - Garching
Tel: 49-8931-9700

Germany - Haan
Tel: 49-2129-3766400

Germany - Heilbronn
Tel: 49-7131-72400

Germany - Karlsruhe
Tel: 49-721-625370

Germany - Munich
Tel: 49-89-627-144-0
Fax: 49-89-627-144-44

Germany - Rosenheim
Tel: 49-8031-354-560

Israel - Ra'anana
Tel: 972-9-744-7705

Italy - Milan
Tel: 39-0331-742611
Fax: 39-0331-466781

Italy - Padova
Tel: 39-049-7625286

Netherlands - Drunen
Tel: 31-416-690399
Fax: 31-416-690340

Norway - Trondheim
Tel: 47-7288-4388

Poland - Warsaw
Tel: 48-22-3325737

Romania - Bucharest
Tel: 40-21-407-87-50

Spain - Madrid
Tel: 34-91-708-08-90
Fax: 34-91-708-08-91

Sweden - Gothenberg
Tel: 46-31-704-60-40

Sweden - Stockholm
Tel: 46-8-5090-4654

UK - Wokingham
Tel: 44-118-921-5800
Fax: 44-118-921-5820