

GX-N SERIES

DC 3-wire Cylindrical Inductive Proximity Sensor **Amplifier Built-in**

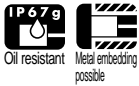

High performance and environmental resistance at low price

Robust in tightening

The tightening torque has been improved to approx. four times greater than that of conventional models because of its thick case. As the sensor can be securely tightened, it does not get loose due to vibration or shock.

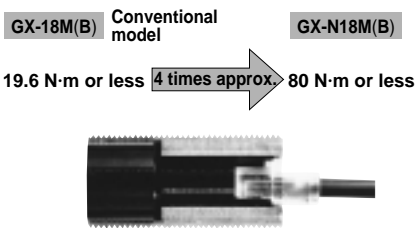

Long sensing range

The **GX-N** series features 1.6 times longer sensing range than conventional models. Setting with enough margin is possible.

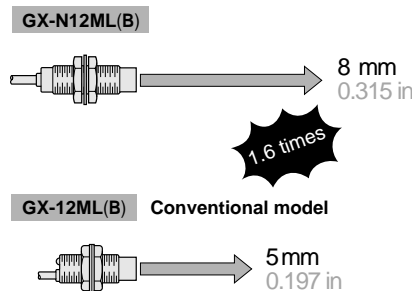

Cost effective

It combines high reliability with cost effectiveness.

Visible operation indicator

The operation indicator (orange) is easily observable from any direction since it is housed in the transparent tail section, which lights up brightly.

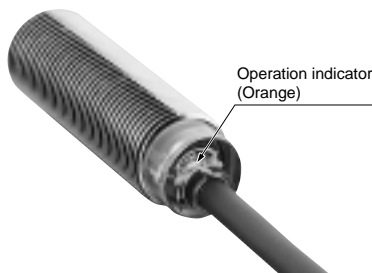

APPLICATIONS

Detecting traveling aluminum pallets

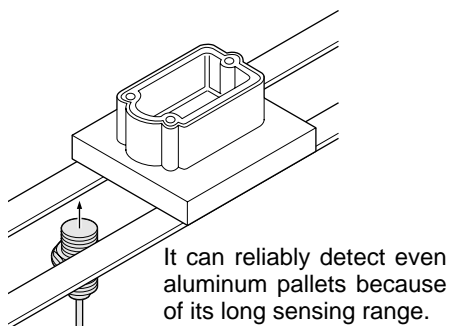

Controlling depth of drilling

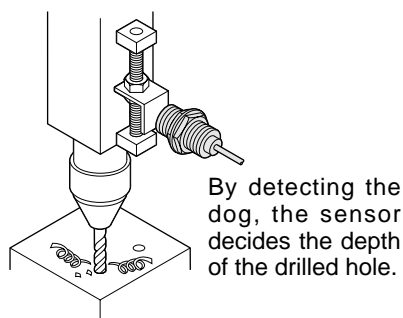

Detecting workpiece in robot hand

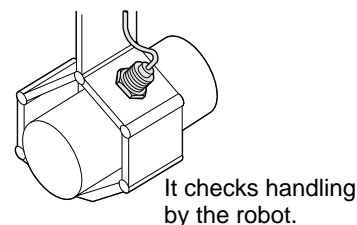

ORDER GUIDE

Type	Appearance (mm in)	Sensing range (Note)	Model No.	Output	Output operation
Shielded type			GX-N12M	NPN open-collector transistor	Normally open
			GX-N12MB		Normally closed
			GX-N18M		Normally open
			GX-N18MB		Normally closed
			GX-N30M		Normally open
			GX-N30MB		Normally closed
Non-shielded type			GX-N12ML	NPN open-collector transistor	Normally open
			GX-N12MLB		Normally closed
			GX-N18ML		Normally open
			GX-N18MLB		Normally closed
			GX-N30ML		Normally open
			GX-N30MLB		Normally closed

Note: The maximum operation distance stands for the maximum distance for which the sensor can detect the standard sensing object.
 The stable sensing range stands for the sensing range for which the sensor can stably detect the standard sensing object even if there is an ambient temperature drift and/or supply voltage fluctuation.

GX-N

ORDER GUIDE

5 m 16.404 ft cable length type

5 m 16.404 ft cable length type (standard: 2 m 6.562 ft) is also available.

• Table of Model Nos.

Type	Standard	5 m 16.404 ft cable length type
Shielded type	GX-N12M	GX-N12M-C5
	GX-N12MB	GX-N12MB-C5
	GX-N18M	GX-N18M-C5
	GX-N18MB	GX-N18MB-C5
	GX-N30M	GX-N30M-C5
	GX-N30MB	GX-N30MB-C5
Non-shielded type	GX-N12ML	GX-N12ML-C5
	GX-N12MLB	GX-N12MLB-C5
	GX-N18ML	GX-N18ML-C5
	GX-N18MLB	GX-N18MLB-C5
	GX-N30ML	GX-N30ML-C5
	GX-N30MLB	GX-N30MLB-C5

OPTIONS

Designation	Model No.	Description	
Protection cover	MS-H12	For GX-N12M(B)	It protects the sensing surface from welding sparks (spatter), etc.
	MS-H18	For GX-N18M(B)	
	MS-H30	For GX-N30M(B)	

Protection cover

- MS-H12
- MS-H18
- MS-H30

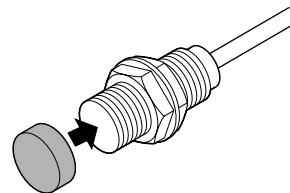

SPECIFICATIONS

Item	Type	Shielded type						Non-shielded type					
	Model No.	GX-N12M	GX-N12MB	GX-N18M	GX-N18MB	GX-N30M	GX-N30MB	GX-N12ML	GX-N12MLB	GX-N18ML	GX-N18MLB	GX-N30ML	GX-N30MLB
Max. operation distance (Note 1)		3 mm 0.118 in ± 10 %		7 mm 0.276 in ± 10 %		10 mm 0.394 in ± 10 %		8 mm 0.315 in ± 10 %		15 mm 0.591 in ± 10 %		22 mm 0.866 in ± 10 %	
Stable sensing range (Note 1)		0 to 2.4 mm 0 to 0.094 in		0 to 5.6 mm 0 to 0.220 in		0 to 8 mm 0 to 0.315 in		0 to 6.4 mm 0 to 0.252 in		0 to 12 mm 0 to 0.472 in		0 to 17.6 mm 0 to 0.693 in	
Standard sensing object		Iron sheet 12 X 12 X t 1 mm 0.472 X 0.472 X t 0.039 in		Iron sheet 18 X 18 X t 1 mm 0.709 X 0.709 X t 0.039 in		Iron sheet 30 X 30 X t 1 mm 1.181 X 1.181 X t 0.039 in		Iron sheet 30 X 30 X t 1 mm 1.181 X 1.181 X t 0.039 in		Iron sheet 50 X 50 X t 1 mm 1.969 X 1.969 X t 0.039 in		Iron sheet 70 X 70 X t 1 mm 2.756 X 2.756 X t 0.039 in	
Hysteresis		20 % or less of operation distance											
Supply voltage		12 to 24 V DC $\pm 10\%$ Ripple P-P 10 % or less											
Current consumption		10 mA or less											
Output		NPN open-collector transistor <ul style="list-style-type: none"> • Maximum sink current: 100 mA • Applied voltage: 30 V DC or less (between output and 0 V) • Residual voltage: 1.5 V or less (at 100 mA sink current) 0.4 V or less (at 16 mA sink current) 											
	Output operation	Normally open	Normally closed	Normally open	Normally closed	Normally open	Normally closed	Normally open	Normally closed	Normally open	Normally closed	Normally open	Normally closed
	Short-circuit protection	Incorporated											
Max. response frequency		450 Hz		300 Hz		300 Hz		350 Hz		100 Hz		100 Hz	
Operation indicator		Orange LED (lights up when the output is ON)											
Environmental resistance	Protection	IP67 (IEC), IP67g (JEM)											
	Ambient temperature	- 25 to + 70 °C - 13 to + 158 °F, Storage: - 30 to + 80 °C - 22 to + 176 °F											
	Ambient humidity	45 to 85 % RH, Storage: 35 to 95 % RH											
	Noise immunity	Power line: 240 Vp, 0.5 μs pulse width (with noise simulator)											
	Voltage withstandability	1,000 V AC for one min. between all supply terminals connected together and enclosure											
	Insulation resistance	50 MΩ, or more, with 250 V DC megger between all supply terminals connected together and enclosure											
	Vibration resistance	10 to 55 Hz frequency, 1.5 mm 0.059 in amplitude in X, Y and Z directions for two hours each											
Shock resistance	1,000 m/s ² acceleration (100 G approx.) in X, Y and Z directions for three times each												
Sensing range variation	Temperature characteristics	Over ambient temperature range - 25 to + 70 °C - 13 to + 158 °F: Within ± 10 % of sensing range at + 20 °C + 68 °F											
	Voltage characteristics	Within ± 2 % for ± 10 % fluctuation of the supply voltage											
Material		Enclosure: Brass (Nickel plated), Sensing part: Nylon, Indicator part: Nylon											
Cable		0.3 mm ² 3-core oil, heat and cold resistant cabtyre cable, 2 m 6.562 ft long											
Cable extension		Extension up to total 100 m 328.084 ft is possible with 0.3 mm ² , or more, cable.											
Weight (Note 2)		65 g approx.		110 g approx.		240 g approx.		65 g approx.		110 g approx.		240 g approx.	
Accessories		Nut: 2 pcs., Toothed lock washer: 1 pc.											

Notes: 1) The maximum operation distance stands for the maximum distance for which the sensor can detect the standard sensing object. The stable sensing range stands for the sensing range for which the sensor can stably detect the standard sensing object even if there is an ambient temperature drift and/or supply voltage fluctuation.
 2) The given weight includes the weight of two nuts and one toothed lock washer.

I/O CIRCUIT AND WIRING DIAGRAMS

I/O circuit diagram

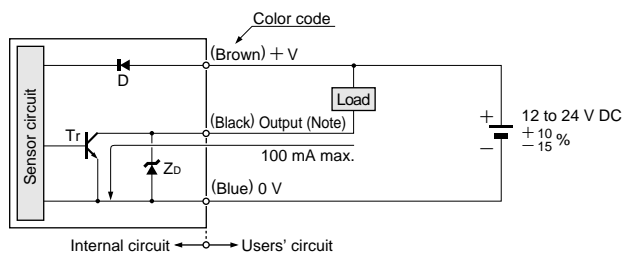

Note: If a capacitive load is directly connected to the output, malfunction may occur.

Symbols ... D : Reverse supply polarity protection diode
 Zd: Surge absorption zener diode
 Tr : NPN output transistor

Wiring diagram

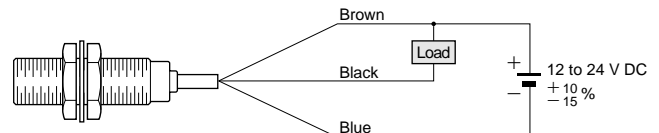

GXL

GL-6

GL-8/8U

GL-N12

GL-18H/18HL

GX-U/FU

GX-N

GX

Amplifier-separated
GA-10/GH

GX-N

SENSING CHARACTERISTICS (TYPICAL)

GX-N12M GX-N12MB

Sensing field

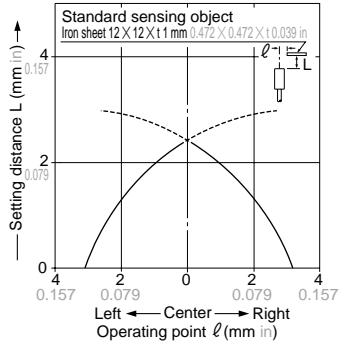

Correlation between sensing object size and sensing range

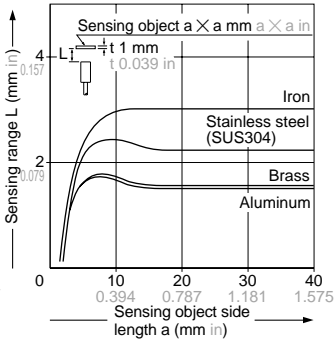

As the sensing object size becomes smaller than the standard size (iron sheet 12 × 12 × t 1 mm 0.472 × 0.472 × t 0.039 in), the sensing range shortens as shown in the left figure.

GX-N18M GX-N18MB

Sensing field

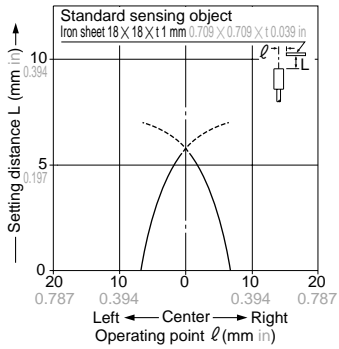

Correlation between sensing object size and sensing range

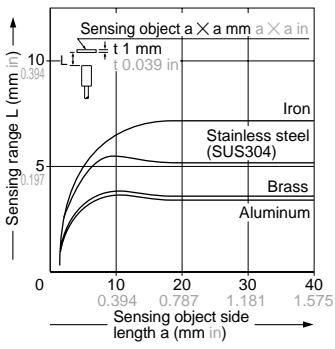

As the sensing object size becomes smaller than the standard size (iron sheet 18 × 18 × t 1 mm 0.709 × 0.709 × t 0.039 in), the sensing range shortens as shown in the left figure.

GX-N30M GX-N30MB

Sensing field

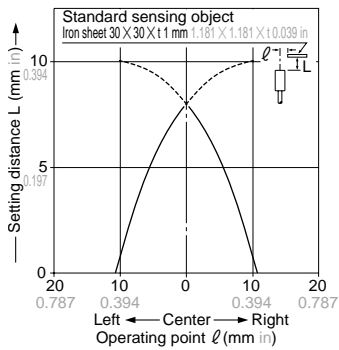

Correlation between sensing object size and sensing range

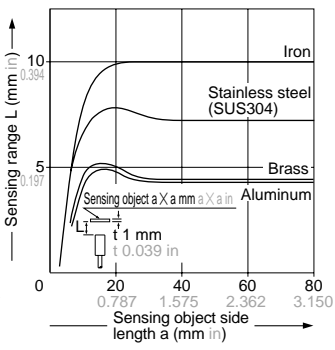

As the sensing object size becomes smaller than the standard size (iron sheet 30 × 30 × t 1 mm 1.181 × 1.181 × t 0.039 in), the sensing range shortens as shown in the left figure.

GX-N12ML GX-N12MLB

Sensing field

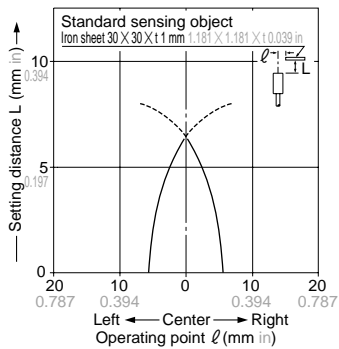

Correlation between sensing object size and sensing range

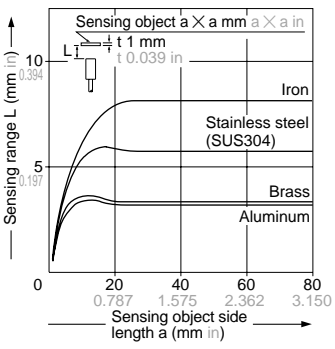

As the sensing object size becomes smaller than the standard size (iron sheet 30 × 30 × t 1 mm 1.181 × 1.181 × t 0.039 in), the sensing range shortens as shown in the left figure.

SENSING CHARACTERISTICS (TYPICAL)

GX-N18ML GX-N18MLB

Sensing field

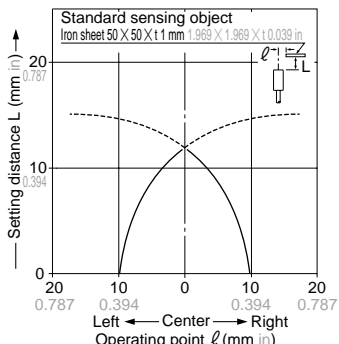

Correlation between sensing object size and sensing range

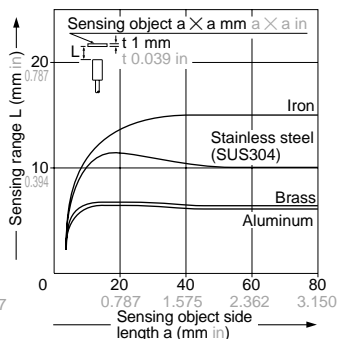

As the sensing object size becomes smaller than the standard size (iron sheet 50 × 50 × t 1 mm 1.969 × 1.969 × t 0.039 in), the sensing range shortens as shown in the left figure.

GX-N30ML GX-N30MLB

Sensing field

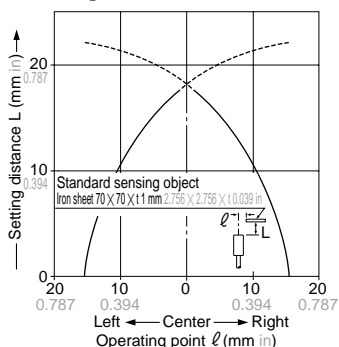

Correlation between sensing object size and sensing range

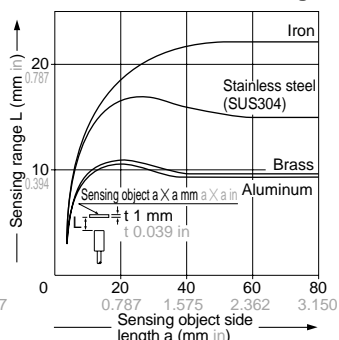

As the sensing object size becomes smaller than the standard size (iron sheet 70 × 70 × t 1 mm 2.756 × 2.756 × t 0.039 in), the sensing range shortens as shown in the left figure.

GX-N

PRECAUTIONS FOR PROPER USE

Refer to p.1152~ for general precautions.



This product is not a safety sensor. Its use is not intended or designed to protect life and prevent body injury or property damage from dangerous parts of machinery. It is a normal object detection sensor.

Mounting

- The tightening torque should be as given below.

Shielded type

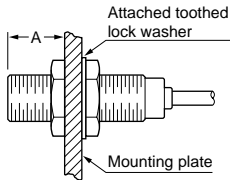

Non-shielded type

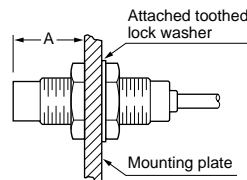

Model No.	Dimension A (mm in)	Tightening torque
GX-N12M(B)	3.5 to 13.5 0.138 to 0.531	10 N·m
	13.5 0.531 or more	20 N·m
GX-N18M(B)	4 to 18 0.157 to 0.709	45 N·m
	18 0.709 or more	80 N·m
GX-N30M(B)	5 to 21 0.197 to 0.827	80 N·m
	21 0.827 or more	180 N·m
GX-N12ML(B)	15 0.591 or more	20 N·m
GX-N18ML(B)	25 0.984 or more	80 N·m
GX-N30ML(B)	30 1.181 or more	180 N·m

Note: Mount such that the nuts do not protrude from the threaded portion.

Distance from surrounding metal

- As metal around the sensor may affect the sensing performance, pay attention to the following points.

Influence of surrounding metal

- The surrounding metal will affect the sensing performance. Keep the minimum distance specified in the table below.

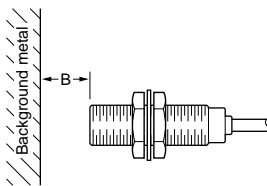

Model No.	B (mm in)
GX-N12M(B)	8 0.315
GX-N18M(B)	20 0.787
GX-N30M(B)	40 1.575
GX-N12ML(B)	22 0.866
GX-N18ML(B)	45 1.772
GX-N30ML(B)	75 2.953

Embedding of the sensor in metal

- Sensing range may decrease if the sensor is completely embedded in metal. Especially for the non-shielded type, keep the minimum distance specified in the table below.

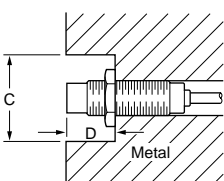

Model No.	C (mm in)	D (mm in)
GX-N12ML(B)	φ50 φ1.969	15 0.591
GX-N18ML(B)	φ75 φ2.953	25 0.984
GX-N30ML(B)	φ105 φ4.134	30 1.181

Note: With the non-shielded type, the sensing range may vary depending on the position of the nuts.

Mutual interference

- When two or more sensors are installed in parallel or face to face, keep the minimum separation distance specified below to avoid mutual interference.

Face to face mounting

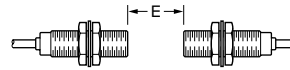

Parallel mounting

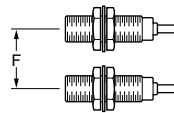

Model No.	E (mm in)	F (mm in)
GX-N12M(B)	25 0.984	15 0.591
GX-N18M(B)	50 1.969	35 1.378
GX-N30M(B)	90 3.543	55 2.165
GX-N12ML(B)	120 4.724	70 2.756
GX-N18ML(B)	180 7.087	125 4.921
GX-N30ML(B)	290 11.417	190 7.480

Sensing range

- The sensing range is specified for the standard sensing object. With a non-ferrous metal, the sensing range is obtained by multiplying with the correction coefficient specified below.

Correction coefficient

Model No.	GX-N12M(B)	GX-N18M(B)	GX-N30M(B)	GX-N12ML(B)	GX-N18ML(B)	GX-N30ML(B)
Metal						
Iron	1	1	1	1	1	1
Stainless steel (SUS304)	0.77 approx.	0.73 approx.	0.70 approx.	0.66 approx.	0.68 approx.	0.65 approx.
Brass	0.52 approx.	0.50 approx.	0.45 approx.	0.44 approx.	0.46 approx.	0.44 approx.
Aluminum	0.51 approx.	0.48 approx.	0.44 approx.	0.43 approx.	0.44 approx.	0.43 approx.

Note: The sensing range also changes if the sensing object is plated.

Protection cover (Optional)

- It protects the sensing surface from welding sparks (spatter), etc.

Mounting method

Protection cover Sensor

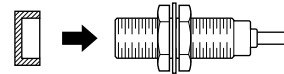

Material: Fluorine resin

Model No.	Applicable model No.
MS-H12	GX-N12M(B)
MS-H18	GX-N18M(B)
MS-H30	GX-N30M(B)

Note: Mount the protection cover so that there is no gap between it and the sensing surface.

Others

- Do not use during the initial transient time (50 ms) after the power supply is switched on.
- When the sensor is mounted on a moving base, stress should not be applied to the sensor cable joint.

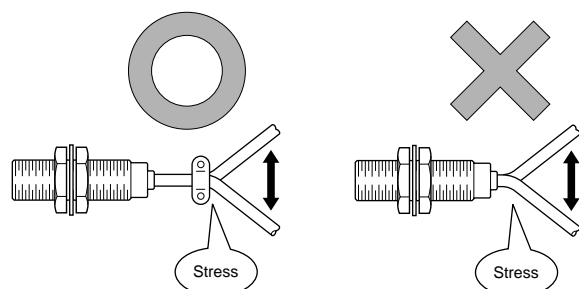

DIMENSIONS (Unit: mm in) The CAD data in the dimensions can be downloaded from the SUNX website: <http://www.sunx.co.jp/>

**GX-N12M
GX-N12MB** Sensor

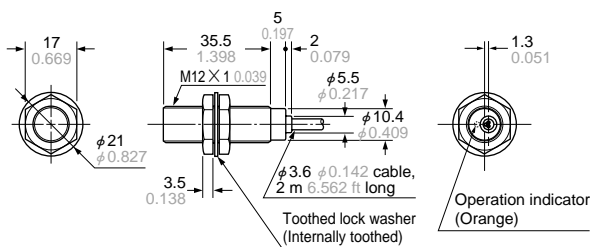

**GX-N12ML
GX-N12MLB** Sensor

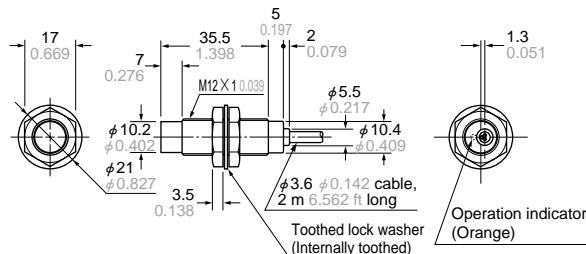

**GX-N18M
GX-N18MB** Sensor

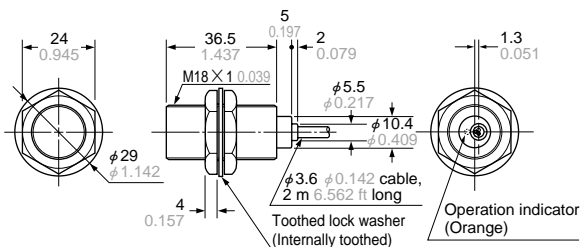

**GX-N18ML
GX-N18MLB** Sensor

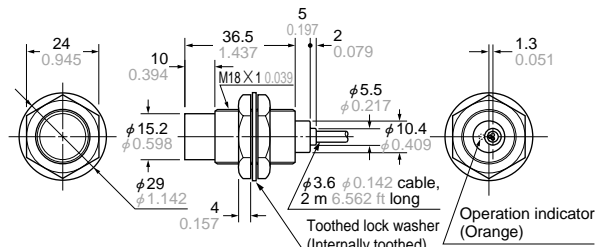

**GX-N30M
GX-N30MB** Sensor

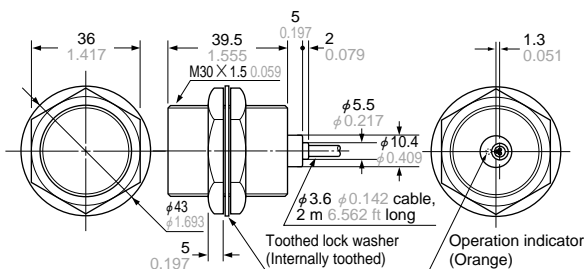

**GX-N30ML
GX-N30MLB** Sensor

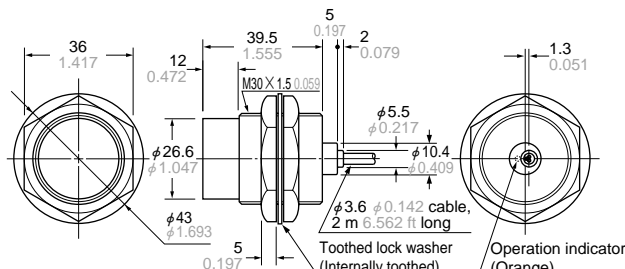

**MS-H12 MS-H18
MS-H30** Protection cover (Optional)

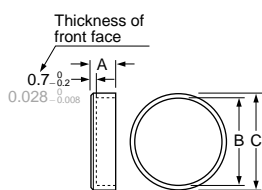

Symbol	A	B	C	Applicable model No.
MS-H12	5 0.197	φ 11.5 φ 0.453	φ 14 φ 0.551	GX-N12M(B)
MS-H18	6 0.236	φ 17.5 φ 0.689	φ 20 φ 0.787	GX-N18M(B)
MS-H30	8 0.315	φ 29.4 φ 1.157	φ 33 φ 1.299	GX-N30M(B)