



STD6NF10 STU6NF10

N-channel 100 V, 0.22 Ω , 6 A, DPAK, IPAK
low gate charge STripFET™ Power MOSFET

Features

Type	V _{DSS}	R _{DS(on)} max	I _D
STD6NF10	100 V	< 0.250 Ω	6 A
STU6NF10	100 V	< 0.250 Ω	6 A

- Exceptional dv/dt capability
- 100% avalanche tested

Application

- Switching applications

Description

This Power MOSFET series realized with STMicroelectronics unique STripFET process has specifically been designed to minimize input capacitance and gate charge. It is therefore suitable as primary switch in advanced high-efficiency, high-frequency isolated DC-DC converters for telecom and computer applications. It is also intended for any applications with low gate drive requirements.

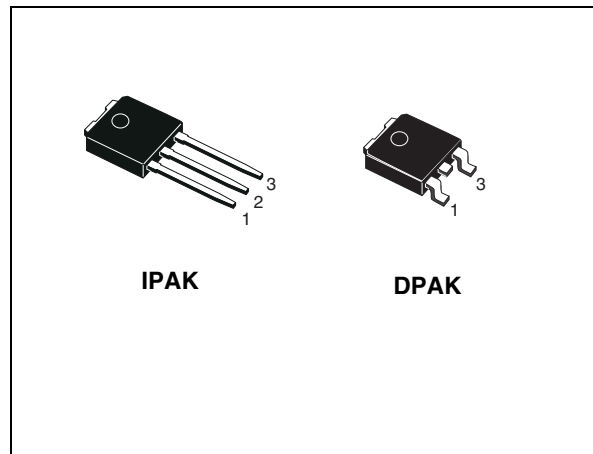

Figure 1. Internal schematic diagram

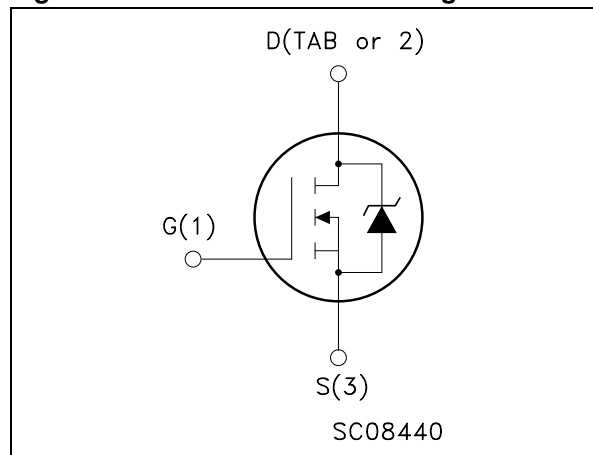

Table 1. Device summary

Order codes	Marking	Package	Packaging
STD6NF10T4	D6NF10	DPAK	Tape and reel
STU6NF10	6NF10	IPAK	Tube

Contents

1	Electrical ratings	3
2	Electrical characteristics	4
2.1	Electrical characteristics (curves)	6
3	Test circuits	8
4	Package mechanical data	9
5	Packing mechanical data	12
6	Revision history	13

1 Electrical ratings

Table 2. Absolute maximum ratings

Symbol	Parameter	Value	Unit
V_{DS}	Drain-source voltage ($V_{GS} = 0$)	100	V
V_{GS}	Gate- source voltage	± 20	V
I_D	Drain current (continuous) at $T_C = 25\text{ }^\circ\text{C}$	6	A
I_D	Drain current (continuous) at $T_C = 100\text{ }^\circ\text{C}$	4	A
$I_{DM}^{(1)}$	Drain current (pulsed)	24	A
P_{tot}	Total dissipation at $T_C = 25\text{ }^\circ\text{C}$	30	W
	Derating factor	0.2	W/ $^\circ\text{C}$
$dv/dt^{(2)}$	Peak diode recovery voltage slope	40	V/ns
$E_{AS}^{(3)}$	Single pulse avalanche energy	200	mJ
T_{stg}	Storage temperature	-65 to 175	$^\circ\text{C}$
T_j	Max. operating junction temperature		

1. Pulse width limited by safe operating area.
2. $I_{SD} \leq 6\text{ A}$, $di/dt \leq 300\text{ A}/\mu\text{s}$, $V_{DD} \leq V_{(BR)DSS}$, $T_j \leq T_{JMAX}$
3. Starting $T_j = 25\text{ }^\circ\text{C}$, $I_D = 3\text{ A}$, $V_{DD} = 50\text{ V}$

Table 3. Thermal data

Symbol	Parameter	Value	Unit
$R_{thj-case}$	Thermal resistance junction-case max	5	$^\circ\text{C}/\text{W}$
$R_{thj-amb}$	Thermal resistance junction-ambient max	100	$^\circ\text{C}/\text{W}$
T_J	Maximum lead temperature for soldering purpose	300	$^\circ\text{C}$

2 Electrical characteristics

($T_{CASE} = 25\text{ °C}$ unless otherwise specified)

Table 4. On/off states

Symbol	Parameter	Test conditions	Min.	Typ.	Max.	Unit
$V_{(BR)DSS}$	Drain-source breakdown voltage	$I_D = 250\text{ }\mu\text{A}$, $V_{GS} = 0$	100			V
I_{DSS}	Zero gate voltage drain current ($V_{GS} = 0$)	$V_{DS} = \text{max rating}$ $V_{DS} = \text{max rating}$, $T_C = 125\text{ °C}$			1 10	μA μA
I_{GSS}	Gate-body leakage current ($V_{DS} = 0$)	$V_{GS} = \pm 20\text{ V}$			± 100	nA
$V_{GS(th)}$	Gate threshold voltage	$V_{DS} = V_{GS}$, $I_D = 250\text{ }\mu\text{A}$	2		4	V
$R_{DS(on)}$	Static drain-source on resistance	$V_{GS} = 10\text{ V}$, $I_D = 3\text{ A}$		0.22	0.25	Ω

Table 5. Dynamic

Symbol	Parameter	Test conditions	Min.	Typ.	Max.	Unit
$g_{fs}^{(1)}$	Forward transconductance	$V_{DS} = > I_{D(on)} \times R_{DS(on)max}$, $I_D = 3\text{ A}$		34		S
C_{iss} C_{oss} C_{rss}	Input capacitance Output capacitance Reverse transfer capacitance	$V_{DS} = 25\text{ V}$, $f = 1\text{ MHz}$, $V_{GS} = 0$		280 45 20		pF pF pF
$t_{d(on)}$ t_r $t_{d(off)}$ t_f	Turn-on delay time Rise time Turn-off delay time Fall time	$V_{DD} = 50\text{ V}$, $I_D = 3\text{ A}$ $R_G = 4.7\text{ }\Omega$, $V_{GS} = 10\text{ V}$ (see Figure 13)		6 10 20 3		ns ns ns ns
Q_g Q_{gs} Q_{gd}	Total gate charge Gate-source charge Gate-drain charge	$V_{DD} = 80\text{ V}$, $I_D = 6\text{ A}$, $V_{GS} = 10\text{ V}$, $R_G = 4.7\text{ }\Omega$ (see Figure 14)		10 2.5 4	14	nC nC nC

1. Pulsed: Pulse duration = 300 μs , duty cycle 1.5%.

Table 6. Source drain diode

Symbol	Parameter	Test conditions	Min.	Typ.	Max.	Unit
I_{SD} $I_{SDM}^{(1)}$	Source-drain current Source-drain current (pulsed)				6 24	A A
$V_{SD}^{(2)}$	Forward on voltage	$I_{SD} = 6\text{ A}$, $V_{GS} = 0$			1.3	V
t_{rr} Q_{rr} I_{RRM}	Reverse recovery time Reverse recovery charge Reverse recovery current	$I_{SD} = 6\text{ A}$, $di/dt = 100\text{ A}/\mu\text{s}$, $V_{DD} = 10\text{ V}$, $T_j = 150\text{ }^\circ\text{C}$ (see Figure 15)		70 175 5		ns nC A

1. Pulse width limited by safe operating area.
2. Pulsed: Pulse duration = 300 μs , duty cycle 1.5%

2.1 Electrical characteristics (curves)

Figure 2. Safe operating area

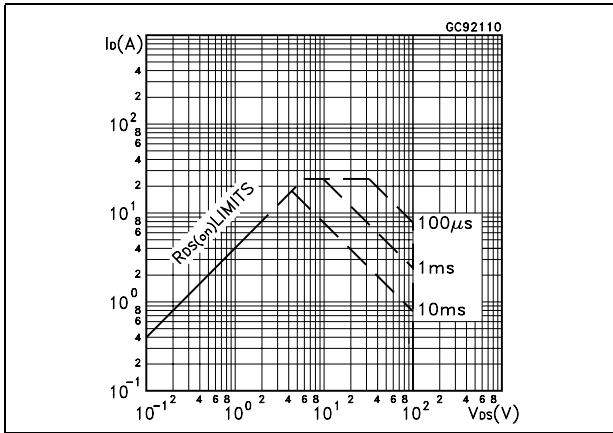

Figure 3. Thermal impedance

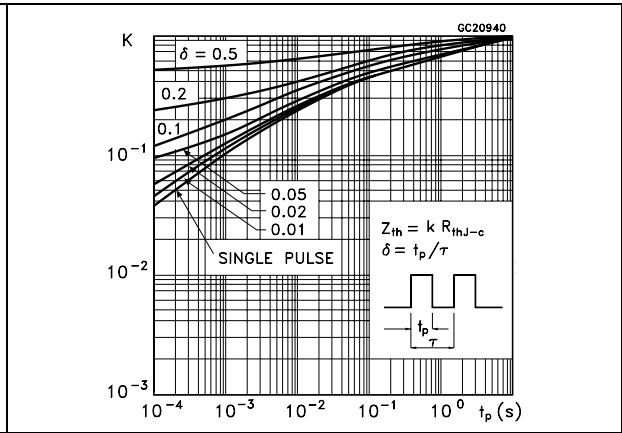

Figure 4. Output characteristics

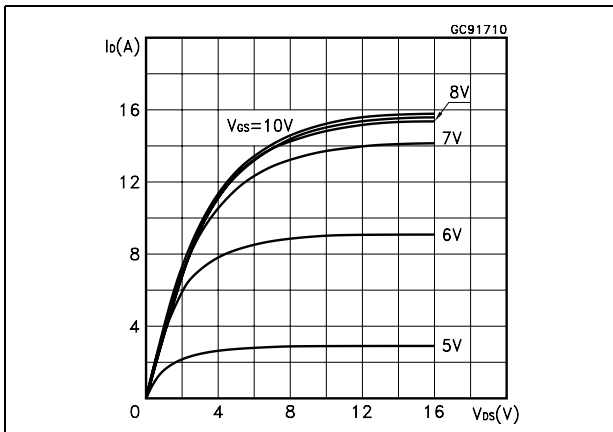

Figure 5. Transfer characteristics

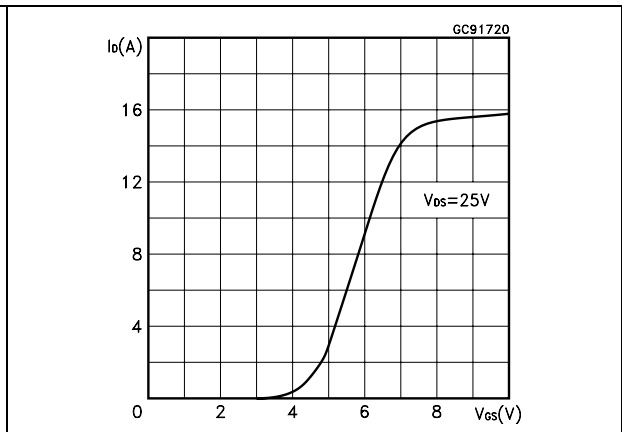

Figure 6. Transconductance

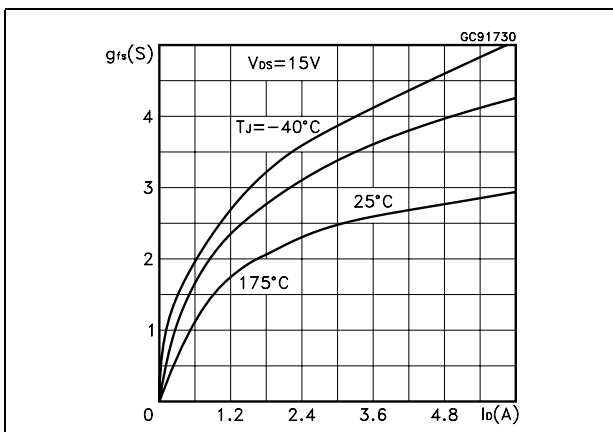

Figure 7. Static drain-source on resistance

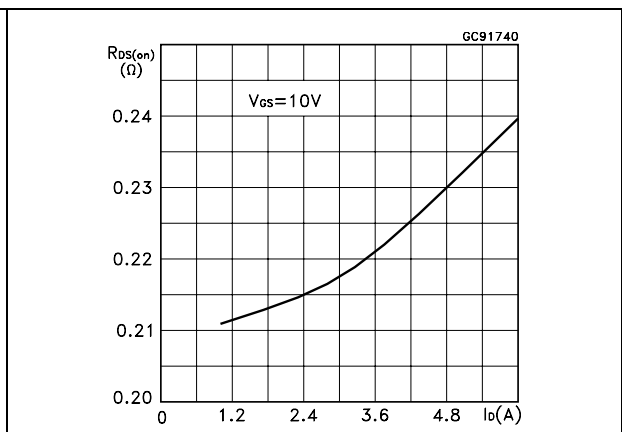

Figure 8. Gate charge vs. gate-source voltage Figure 9. Capacitance variations

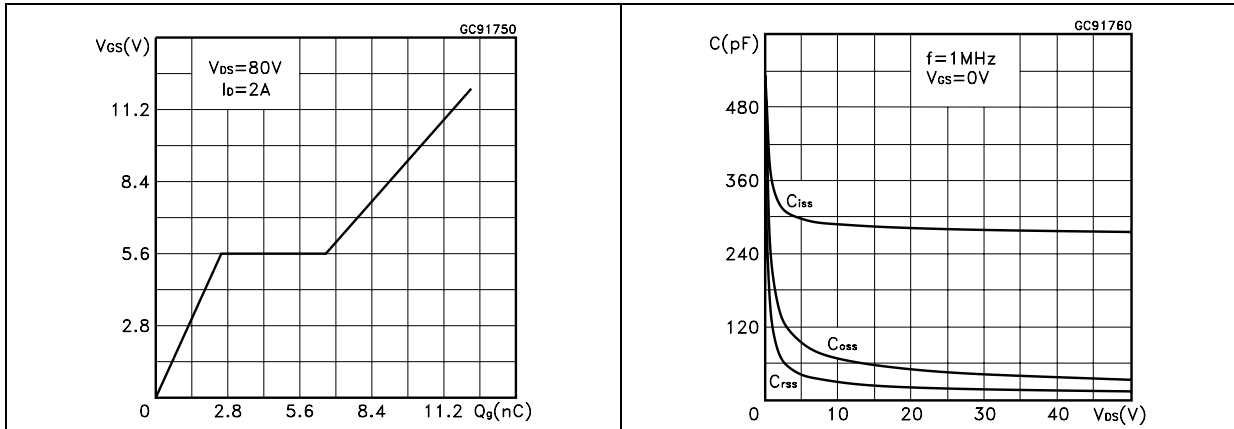

Figure 10. Normalized gate threshold voltage vs. temperature Figure 11. Normalized on resistance vs. temperature

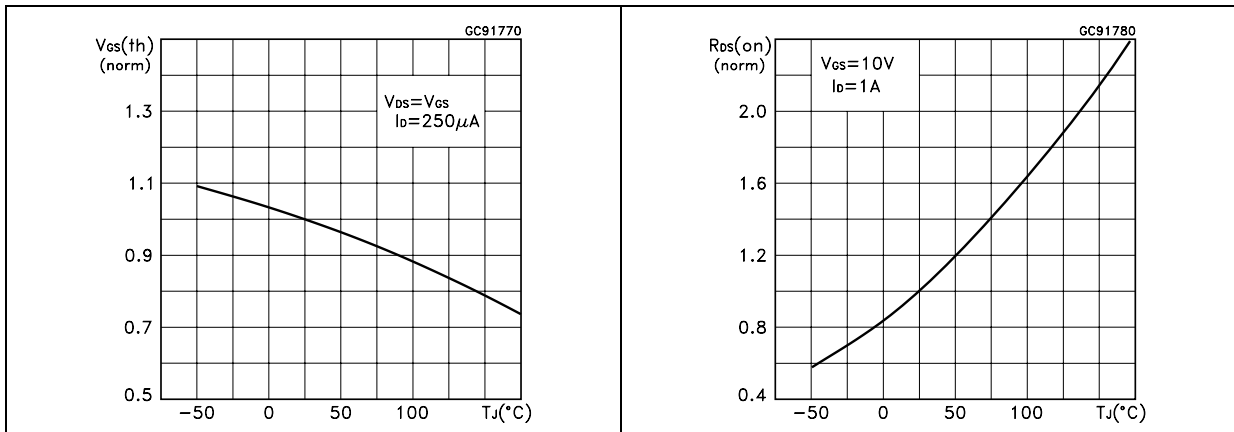
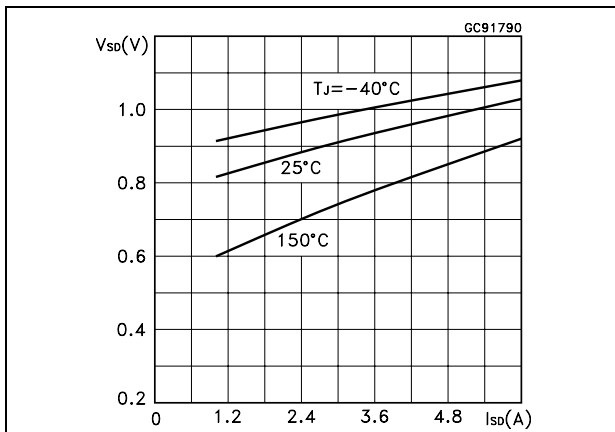

Figure 12. Source-drain diode forward characteristics



3 Test circuits

Figure 13. Switching times test circuit for resistive load



Figure 14. Gate charge test circuit



Figure 15. Test circuit for inductive load switching and diode recovery times



Figure 16. Unclamped Inductive load test circuit

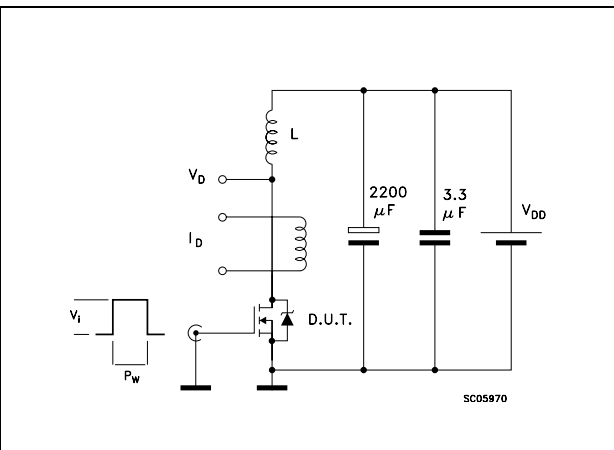
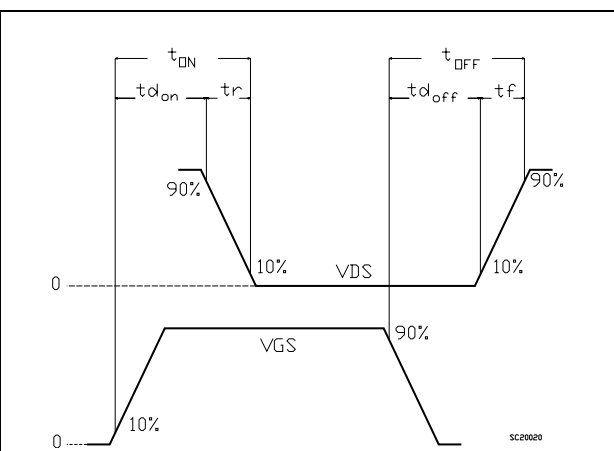

Figure 17. Unclamped inductive waveform



Figure 18. Switching time waveform



4 Package mechanical data

In order to meet environmental requirements, ST offers these devices in ECOPACK® packages. These packages have a Lead-free second level interconnect. The category of second level interconnect is marked on the package and on the inner box label, in compliance with JEDEC Standard JESD97. The maximum ratings related to soldering conditions are also marked on the inner box label. ECOPACK is an ST trademark. ECOPACK specifications are available at: www.st.com

TO-251 (IPAK) mechanical data

DIM.	mm.		
	min.	typ	max.
A	2.20		2.40
A1	0.90		1.10
b	0.64		0.90
b2			0.95
b4	5.20		5.40
c	0.45		0.60
c2	0.48		0.60
D	6.00		6.20
E	6.40		6.60
e		2.28	
e1	4.40		4.60
H		16.10	
L	9.00		9.40
(L1)	0.80		1.20
L2		0.80	
V1		10°	

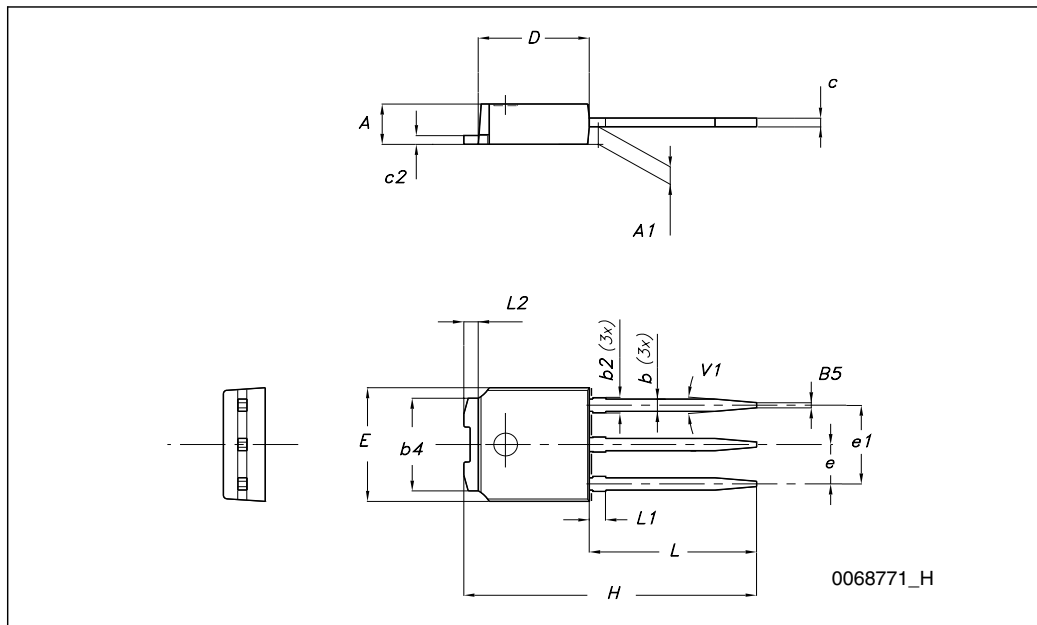

TO-252 (DPAK) mechanical data

DIM.	mm.		
	min.	typ	max.
A	2.20		2.40
A1	0.90		1.10
A2	0.03		0.23
b	0.64		0.90
b4	5.20		5.40
c	0.45		0.60
c2	0.48		0.60
D	6.00		6.20
D1		5.10	
E	6.40		6.60
E1		4.70	
e		2.28	
e1	4.40		4.60
H	9.35		10.10
L	1		
L1		2.80	
L2		0.80	
L4	0.60		1
R		0.20	
V2	0°		8°

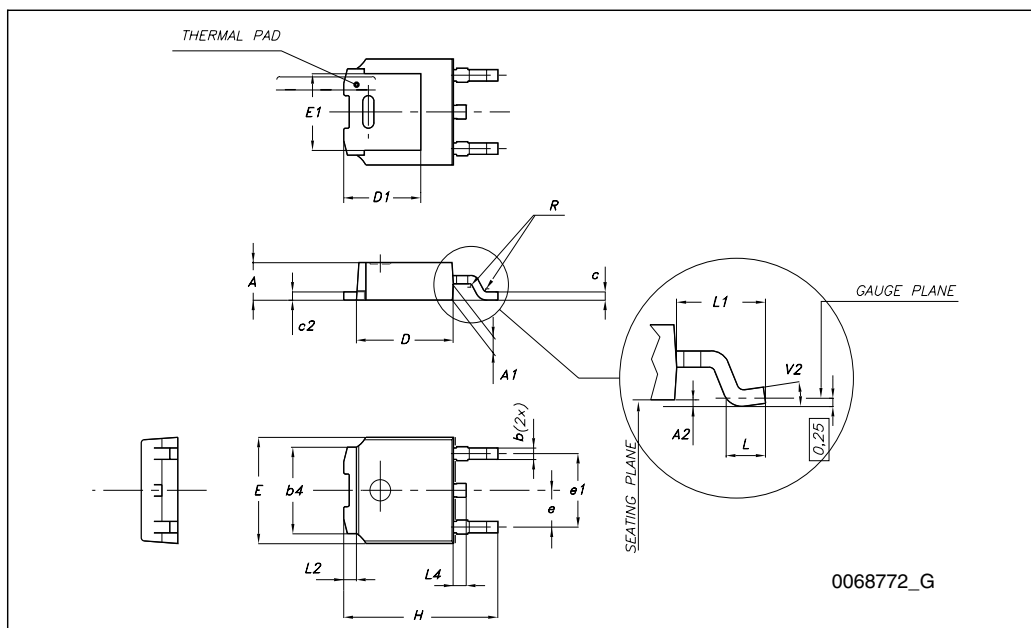

5 Packing mechanical data

DPAK FOOTPRINT

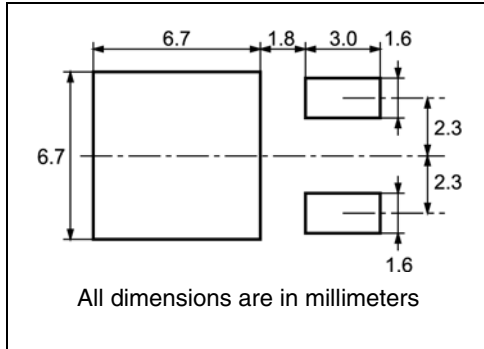

TAPE AND REEL SHIPMENT

40 mm min. Access hole at slot location

Full radius

Tape slot in core for tape start 2.5mm min. width

G measured at hub

REEL MECHANICAL DATA

DIM.	mm		inch	
	MIN.	MAX.	MIN.	MAX.
A		330		12.992
B	1.5		0.059	
C	12.8	13.2	0.504	0.520
D	20.2		0.795	
G	16.4	18.4	0.645	0.724
N	50		1.968	
T		22.4		0.881

TAPE MECHANICAL DATA

DIM.	mm		inch	
	MIN.	MAX.	MIN.	MAX.
A0	6.8	7	0.267	0.275
B0	10.4	10.6	0.409	0.417
B1		12.1		0.476
D	1.5	1.6	0.059	0.063
D1	1.5		0.059	
E	1.65	1.85	0.065	0.073
F	7.4	7.6	0.291	0.299
K0	2.55	2.75	0.100	0.108
P0	3.9	4.1	0.153	0.161
P1	7.9	8.1	0.311	0.319
P2	1.9	2.1	0.075	0.082
R	40		1.574	
W	15.7	16.3	0.618	0.641

TOP COVER TAPE

User Direction of Feed

Center line of cavity

Bending radius R min.

FEED DIRECTION

TRL

For machine ref. only including draft and radii concentric around B0

10 pitches cumulative tolerance on tape +/- 0.2 mm

6 Revision history

Table 7. Document revision history

Date	Revision	Changes
21-Jun-2004	3	Complete version
20-Jul-2006	4	New template, no content change
16-Sep-2008	5	Corrected part number: STU6NF10
19-Nov-2008	6	Marking label in Table 1 for the device in IPAK has been updated. I _{GSS} value in Table 4 has been updated

Please Read Carefully:

Information in this document is provided solely in connection with ST products. STMicroelectronics NV and its subsidiaries ("ST") reserve the right to make changes, corrections, modifications or improvements, to this document, and the products and services described herein at any time, without notice.

All ST products are sold pursuant to ST's terms and conditions of sale.

Purchasers are solely responsible for the choice, selection and use of the ST products and services described herein, and ST assumes no liability whatsoever relating to the choice, selection or use of the ST products and services described herein.

No license, express or implied, by estoppel or otherwise, to any intellectual property rights is granted under this document. If any part of this document refers to any third party products or services it shall not be deemed a license grant by ST for the use of such third party products or services, or any intellectual property contained therein or considered as a warranty covering the use in any manner whatsoever of such third party products or services or any intellectual property contained therein.

UNLESS OTHERWISE SET FORTH IN ST'S TERMS AND CONDITIONS OF SALE ST DISCLAIMS ANY EXPRESS OR IMPLIED WARRANTY WITH RESPECT TO THE USE AND/OR SALE OF ST PRODUCTS INCLUDING WITHOUT LIMITATION IMPLIED WARRANTIES OF MERCHANTABILITY, FITNESS FOR A PARTICULAR PURPOSE (AND THEIR EQUIVALENTS UNDER THE LAWS OF ANY JURISDICTION), OR INFRINGEMENT OF ANY PATENT, COPYRIGHT OR OTHER INTELLECTUAL PROPERTY RIGHT.

UNLESS EXPRESSLY APPROVED IN WRITING BY AN AUTHORIZED ST REPRESENTATIVE, ST PRODUCTS ARE NOT RECOMMENDED, AUTHORIZED OR WARRANTED FOR USE IN MILITARY, AIR CRAFT, SPACE, LIFE SAVING, OR LIFE SUSTAINING APPLICATIONS, NOR IN PRODUCTS OR SYSTEMS WHERE FAILURE OR MALFUNCTION MAY RESULT IN PERSONAL INJURY, DEATH, OR SEVERE PROPERTY OR ENVIRONMENTAL DAMAGE. ST PRODUCTS WHICH ARE NOT SPECIFIED AS "AUTOMOTIVE GRADE" MAY ONLY BE USED IN AUTOMOTIVE APPLICATIONS AT USER'S OWN RISK.

Resale of ST products with provisions different from the statements and/or technical features set forth in this document shall immediately void any warranty granted by ST for the ST product or service described herein and shall not create or extend in any manner whatsoever, any liability of ST.

ST and the ST logo are trademarks or registered trademarks of ST in various countries.

Information in this document supersedes and replaces all information previously supplied.

The ST logo is a registered trademark of STMicroelectronics. All other names are the property of their respective owners.

© 2008 STMicroelectronics - All rights reserved

STMicroelectronics group of companies

Australia - Belgium - Brazil - Canada - China - Czech Republic - Finland - France - Germany - Hong Kong - India - Israel - Italy - Japan - Malaysia - Malta - Morocco - Singapore - Spain - Sweden - Switzerland - United Kingdom - United States of America

www.st.com