

Programmable Controller

## NSJ Series, NSJ

Combining the controller and HMI into a single unit contributes to downsizing and standardizing control panels, while eliminating inefficiency, waste, and inconsistency on production sites.



# NSJ

Set\_Complete Temp\_alarm

Condition Insert01

Run

Shift

# HMI



# CONTROLLER



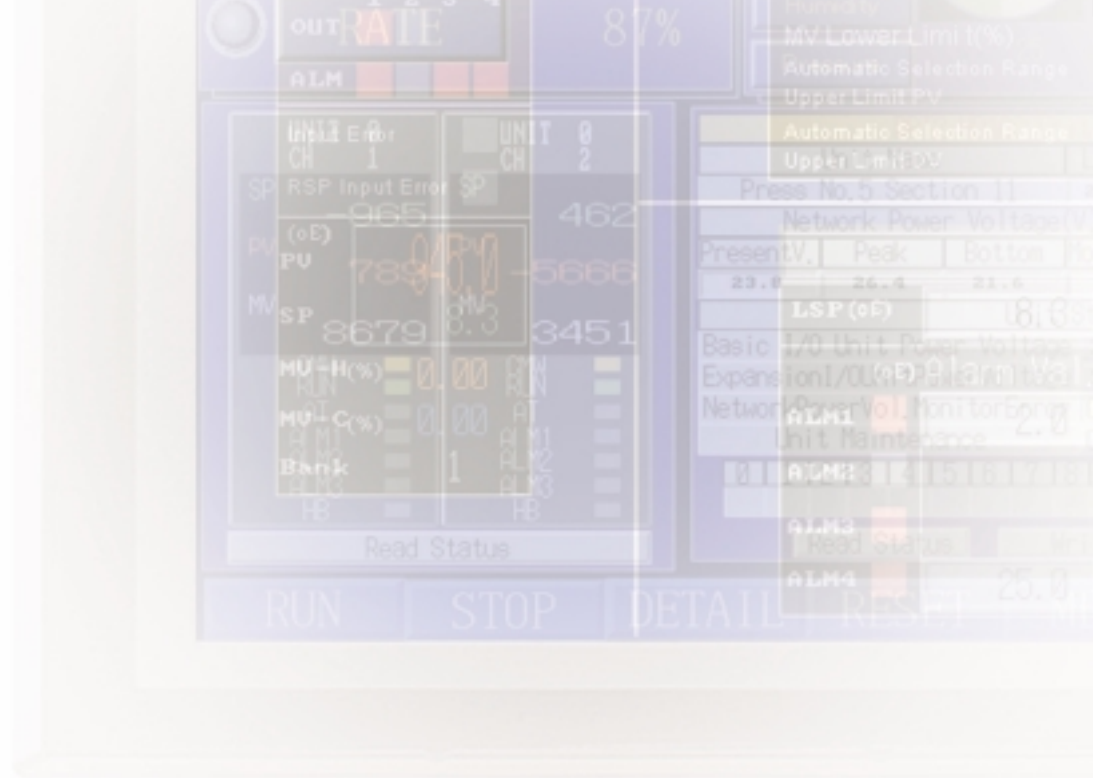

As demands continue to grow for smaller control panels to save space in today's production facilities, OMRON has shown the way with a unique solution -- the SYSMAC One NSJ-series One-package Controller. Its compact size is an ideal fit for the 400- to 500-mm control panel widths that are becoming increasingly common, and it completely eliminates the space that was previously necessary for the PLC. While helping to standardize control panels, the NSJ Series also solves a variety of manufacturing industry problems by raising the levels of efficiency in design and maintenance.

● <b>Concept</b>	<b>4</b>
● <b>Product Line and Expandability</b>	<b>6</b>
● <b>Promoting Standardized Control Panels</b>	<b>8</b>
● <b>Less Effort in Designing and Debugging</b>	<b>10</b>
● <b>Less Effort in Maintenance</b>	<b>12</b>
● <b>Applications</b>	<b>14</b>
● <b>System Configuration</b>	<b>16</b>
● <b>Ordering Information and Specifications</b>	<b>19</b>



# Greater Control Panel Downsizing and Standardizing

As production becomes increasingly globalized, the needs for standardized control panels are growing. With its new, one-package concept, the SYSMAC One NSJ Series contributes to reducing both hardware and software requirements for control panels. While offering the same convenient operation for control panels in any factory, any process, and any device worldwide, the NSJ Series eliminates various forms of inefficiency, waste, and inconsistency that extend all the way from device design and installation, to maintenance.

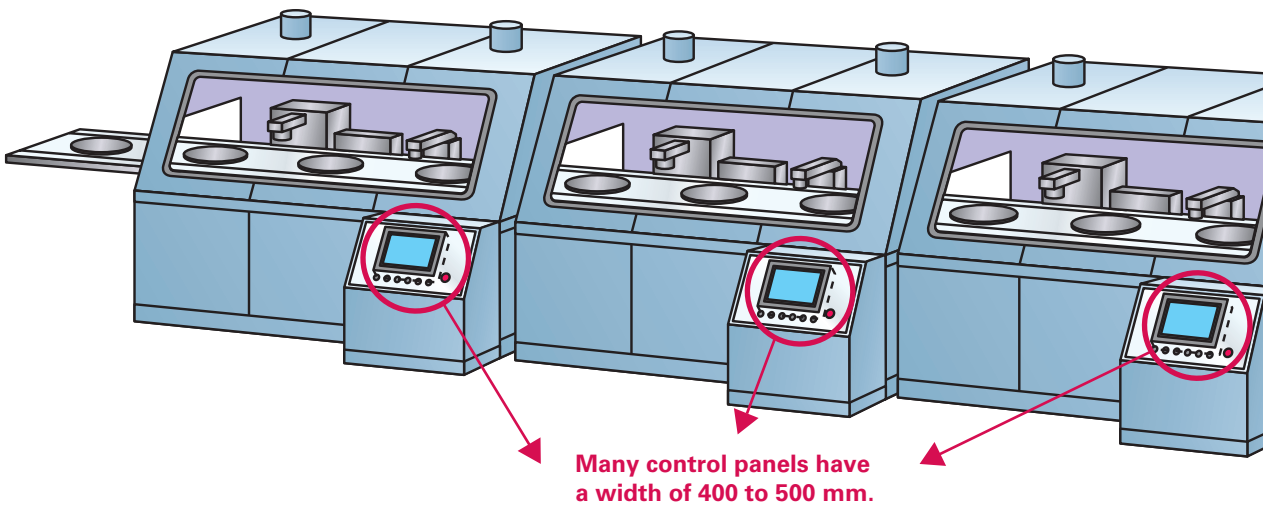

Today's manufacturing facilities are becoming increasingly space-efficient and standardized. The 400- to 500-mm panel width will likely become mainstream.



As an example, the SYSMAC One NSJ5 Series makes it possible to design a control panel this compact.

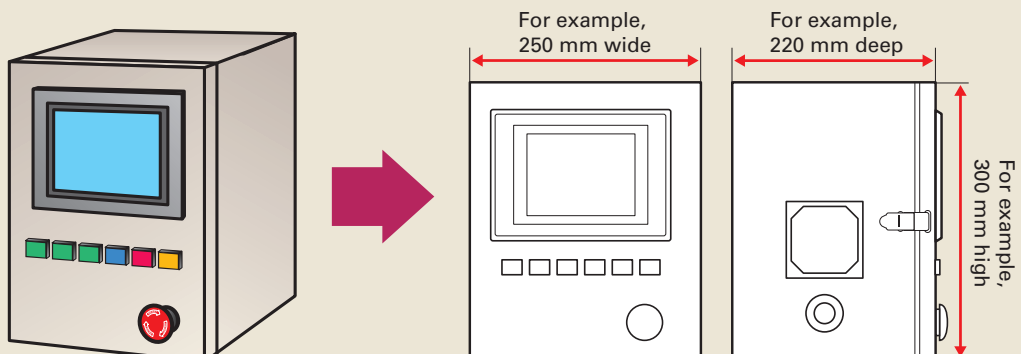

## No More PLC Space Required.

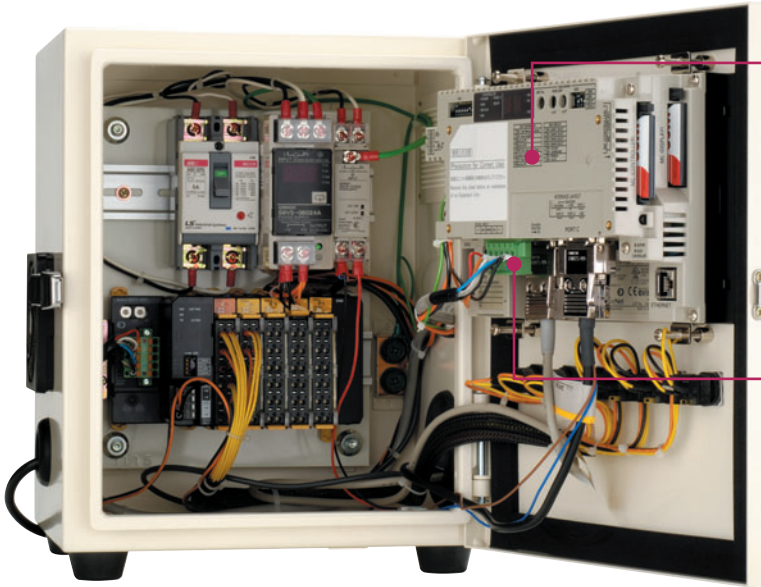

**The PLC comes as standard equipment along with the HMI.**

The Display Section and Controller Section each have a CPU. Control is highly reliable because it is not affected by the designing and communications of the Display Section.

**A DeviceNet Master comes as standard equipment for I/O.**

There is no need for initial settings, and wiring is greatly reduced. Also standardization and streamlining design can be realized.

### Efficient use of the space inside the control panel.

Since there is no PLC space required, the space inside the control panel can be more efficiently used. For example, it can be used to mount the power supply, breakers, or terminal blocks directly behind the Display Section.

### Especially slim at 73.3 mm.

Both the Display Section and Controller Section combined have a width of only 73.3 mm\*. There is also no need for a PLC Power Supply Unit. (\*For the NSJ8/10/12 Series. The NSJ5 Series is 79.0 mm.)

## NSJ Series Appearance and Parts Names

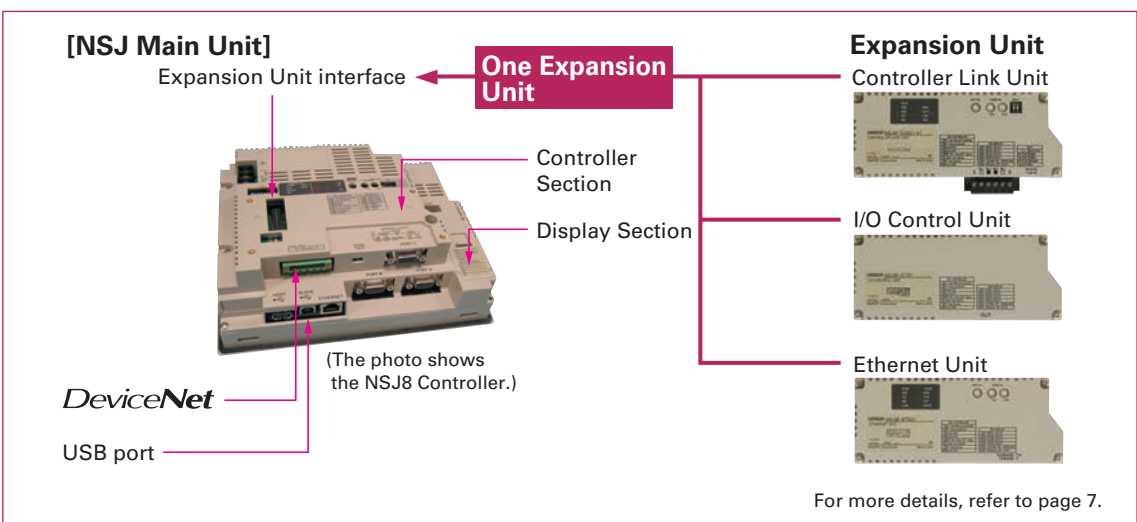
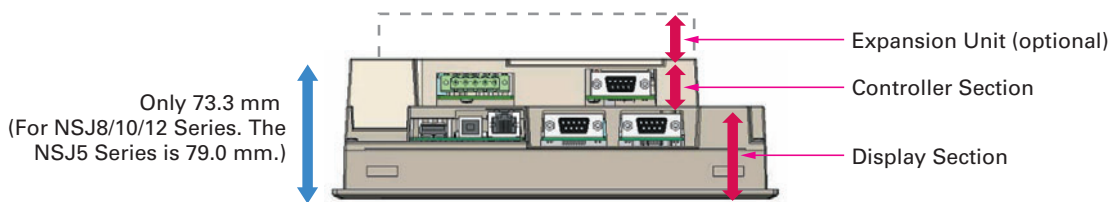

# A Wide Selection of Scalable Display Controllers

## Product Line-up **Select the optimal control and display combination.**

Four screen sizes are available, from 5.7 to 12.1 inches.



## NSJ Built-in Ethernet Port **Easy access to both Display Section and Controller Section**

This allows PLC data to be read or written without adding an Ethernet Unit. PLC data can also be read or written, and alarms and recipes can be transferred, from a host computer.

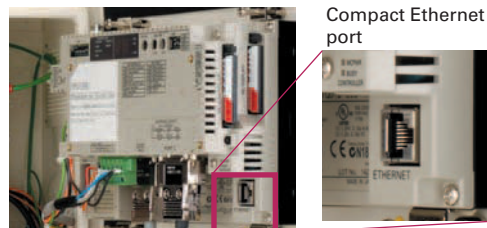

### Easy Access from a Host Computer

- Screen data and ladder programs can be easily transferred via Ethernet.
- PLC data can also be read by a host application (using FINS communications).



### Easy Access to Other PLCs

- PLC2 data can be easily displayed and set from the NSJ (PLC1) display.

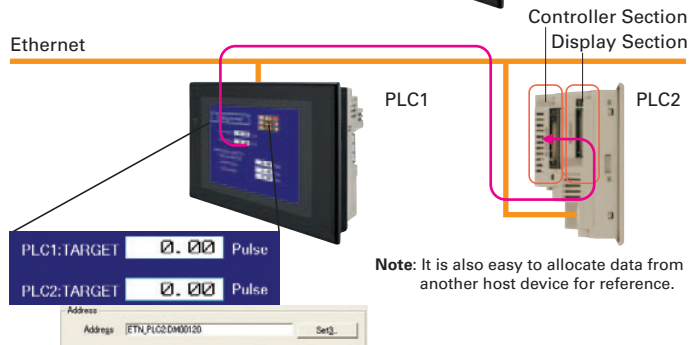

**Expansion Units** Support a wider range of applications.

**Controller Link Unit (NSJW-CLK21-V1)**

**High-speed, large-capacity data link**

The PLC data link function can be used to provide a high-speed, large-capacity data link between Controllers.



**I/O Control Unit (NSJW-IC101)**

**Easy addition of Special I/O Units and CPU Bus Units**

Used to mount Motion Control Units and other Special I/O Units or CPU Bus Units to the NSJ-series Controller, for excellent expandability.

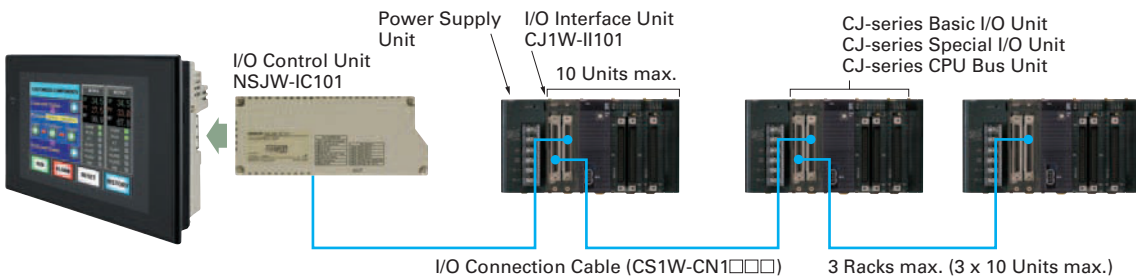

**Ethernet Unit (NSJW-ETN21)**

**Full use of versatile Ethernet functions**

The NSJ built-in Ethernet port increases expandability with host computers by enabling functions such as communications implemented with CMND instructions and e-mail.

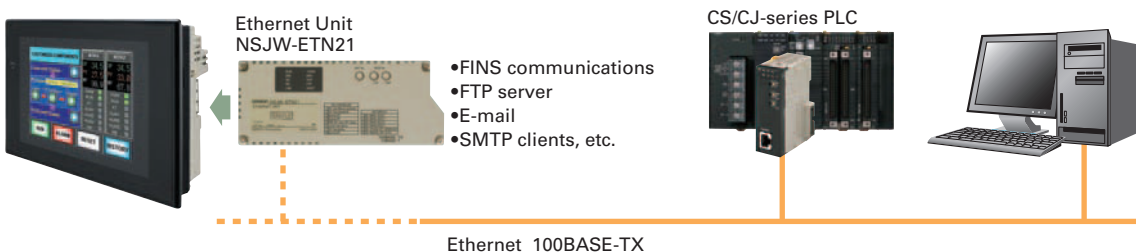

**Note:** For detailed information on functions related to the NSJ built-in Ethernet port and Ethernet Unit, refer to page 28.

# Meeting the Growing Needs for Control Panel Standardization

## The Market Is Moving Toward Standardized Control Panels.

With production bases becoming increasingly globalized, do you have the following concerns about shipping domestically manufactured devices?

- 1 Reduce downtime due to operator error**
- 2 Providing on-site operator training**
- 3 Smoothly procuring maintenance parts when a malfunction occurs**
- 4 The need to raise development efficiency for devices and facilities**

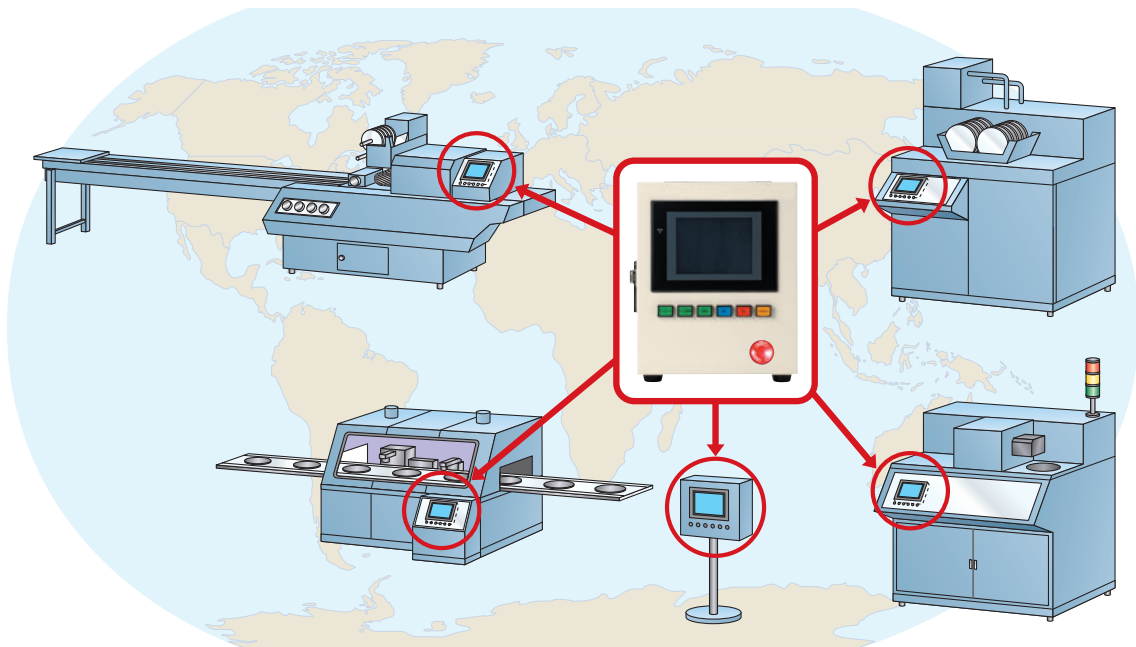

## Effects of Standardizing Control Panels

Waste and inconsistency in design, installation and maintenance can be eliminated by supplying control panels that have the same basic operation regardless of the factory, the process, and the devices used in any country of the world.

- 1 Operating errors can be prevented by providing the same operability. Reduce temporary lower operating efficiency caused by changing operators.**
- 2 There is no need to produce an operating manual for each device. Initial training cost can also be reduced.**
- 3 Standardization greatly reduces the number of maintenance parts. Even if a malfunction occurs, the entire control panel can be replaced as a module for quick and easy system restoration.**
- 4 Standardization makes it possible to create templates for design documents, screens, and ladder programs. This increases the ability to reuse the templates, which greatly raises design efficiency.**



By standardizing control panels based on SYSMAC One, design steps can be reduced and software assets can be reused to eliminate waste and inconsistency all the way from the design stage to system startup.

**Example of Standardized System**

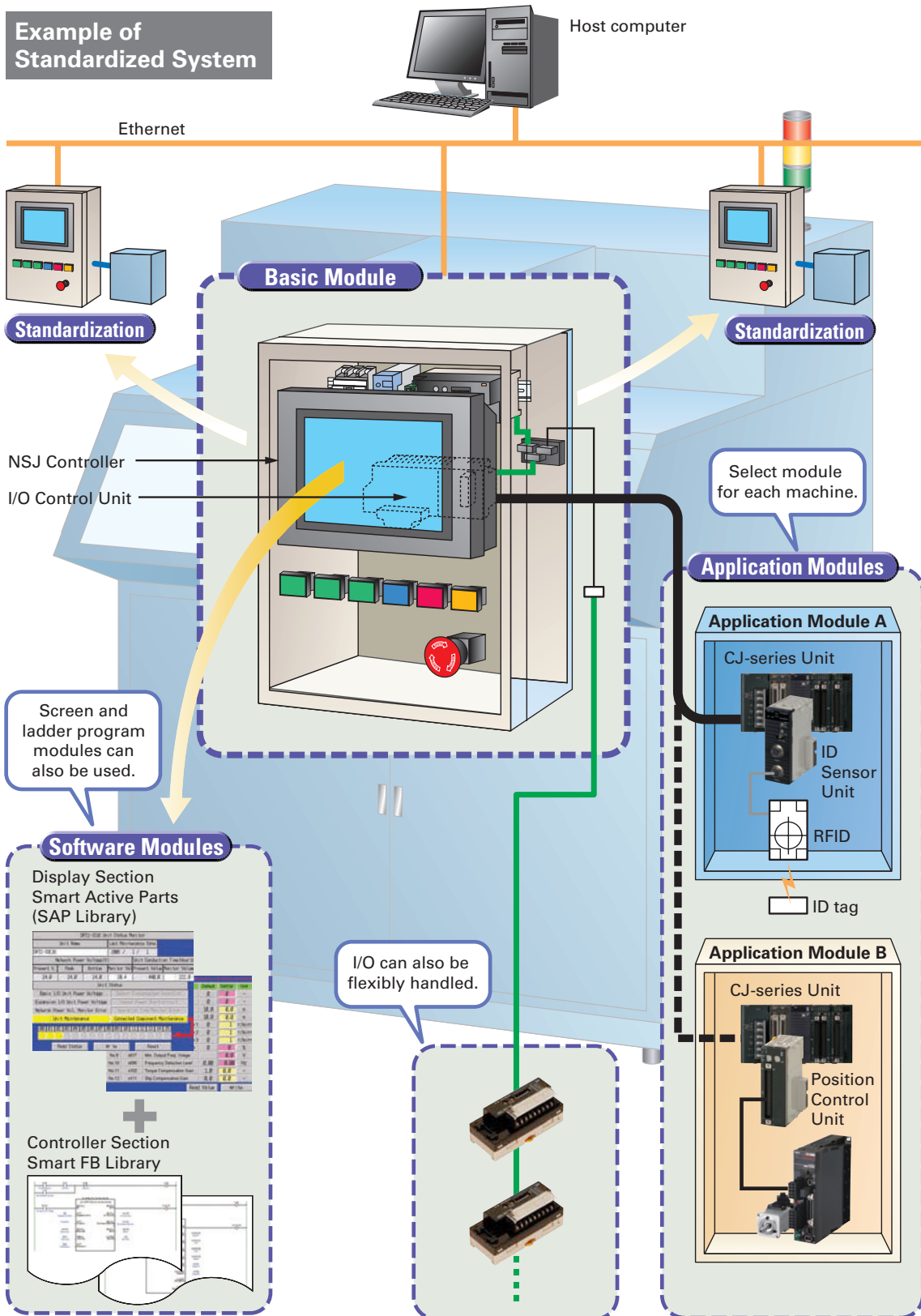

# Less Effort in Designing and Debugging

## Advantages of One Package

### Use of a single USB cable simplifies both design and debugging.

Use of a commercially available USB cable allows easy, high-speed transferring of screen data and ladder programs. There is also no need to change cables for transfers such as these.



Commercially available USB cable

- (1) Power ON
- (2) Simply connect the USB cable and you are ready to transfer screen data and ladder programs.

### Continue using your software assets.

Continue to use all the screen data for NS-series PTs and ladder programs for CS/CJ-series PLCs.

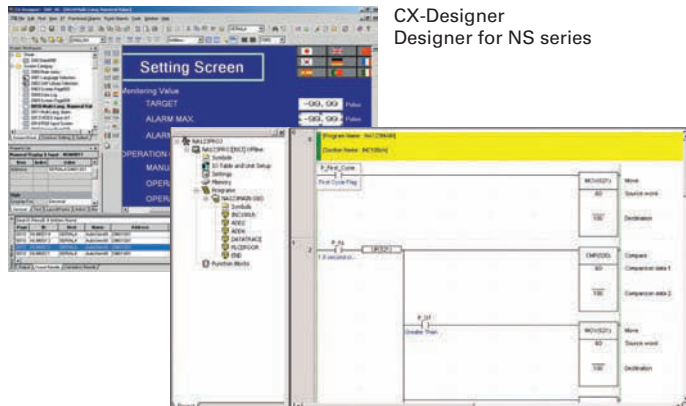

CX-Designer  
Designer for NS series

CX-Programmer Ladder Programming Software

### Simply turn ON the power and start using it. No need for initial settings.

There is no need to connect the Controller Section and Display Section, and no need to make initial communications settings or other settings.

The system starts up as soon as the power is turned ON. Even the standard-equipped DeviceNet Master is completely set in the default settings.

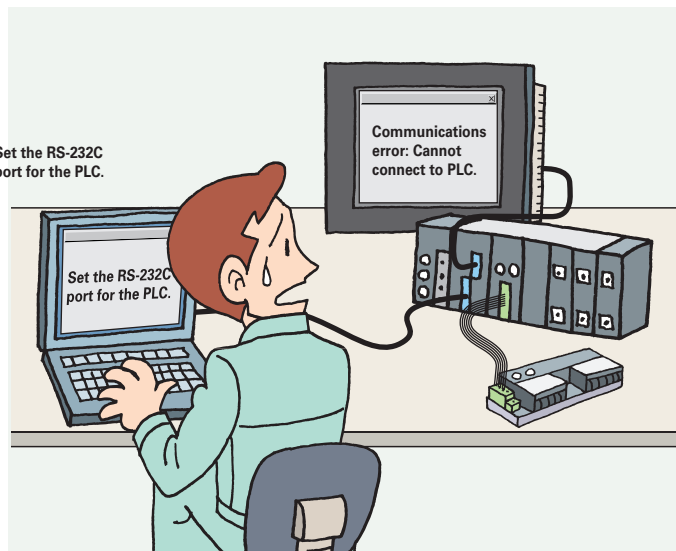

Set the RS-232C port for the PLC.

Communications error: Cannot connect to PLC.

# The CX-One Integrated FA Tool Package Is Available

**This software can be used to debug ladder programs and screens without even having to connect to an actual system.**

The test functions of the CX-Designer Screen Designer for NS Series have been further strengthened. By selecting CX-Simulator as the connection destination, screen data and ladder programs can be simultaneously tested without even having to connect to an actual system.

## Integrated Simulation

• Ladder Program Window

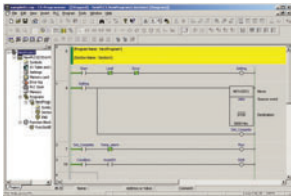

• CX-One version 2.0 or higher on computer

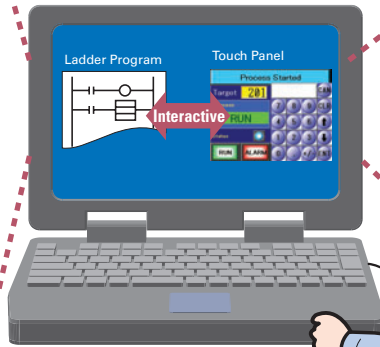

• Touch Screen

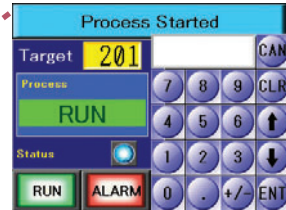

Interactive

**The SAP Library, which dramatically reduces effort in design, has also been greatly expanded.**

More than 2,000 Smart Active Parts (SAP) are available for directly accessing OMRON PLCs and components. Simply copy them from the library and paste them onto the screen. There is absolutely no need to design screens or ladder programs for these objects.

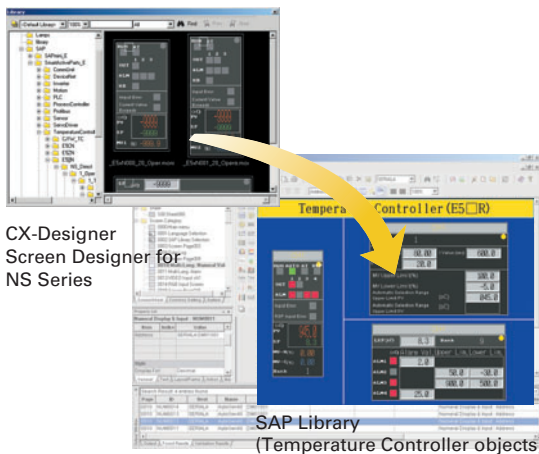

A setting and monitoring screen is instantly completed for Temperature Controllers

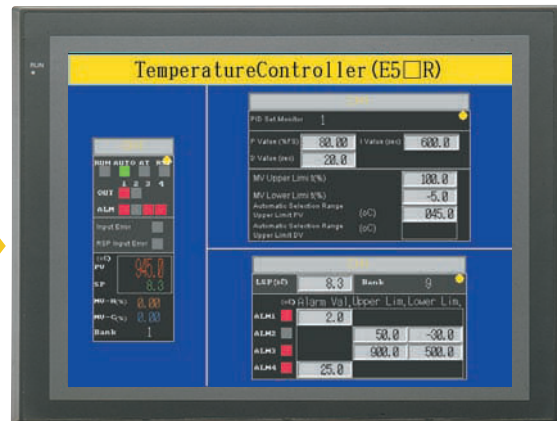

# Less Effort in Maintenance

## Two Troubleshooters Come as a Standard Feature

Enables a quick, on-site action without any software.

The standard-equipped PLC Troubleshooter and DeviceNet Troubleshooter contribute to solving problems during device startup and operation. When an error occurs, simply follow the on-screen instructions to confirm the error details and quickly implement countermeasures, without referring to the manual.

### Customer Screen-creating Window

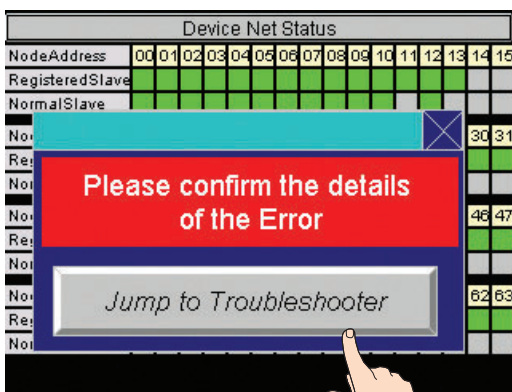

The error details are displayed.

The necessary countermeasure is displayed.

Launch Controller Troubleshooter

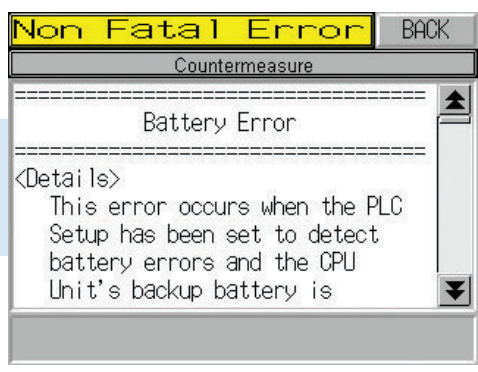
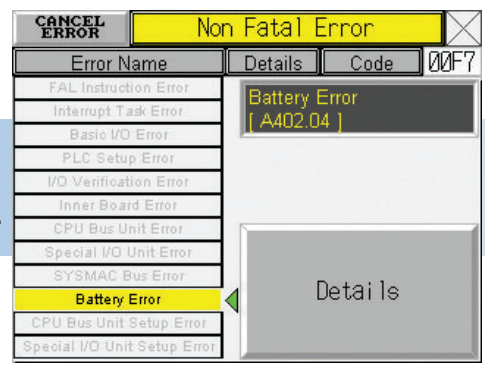

Launch DeviceNet Troubleshooter

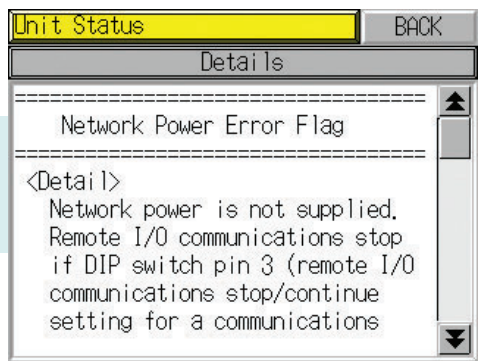
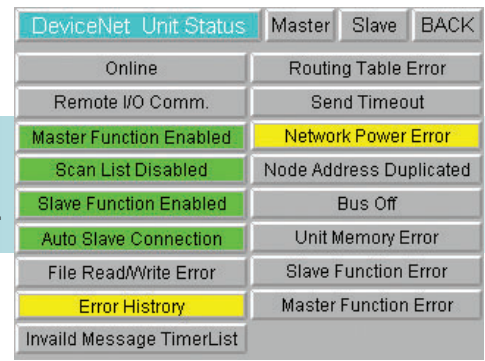

## A Data Backup Function Is Also Standard

### Easy backup without a computer.

Simply follow the on-screen instructions to back up both screen data and ladder programs for the Controller Section.

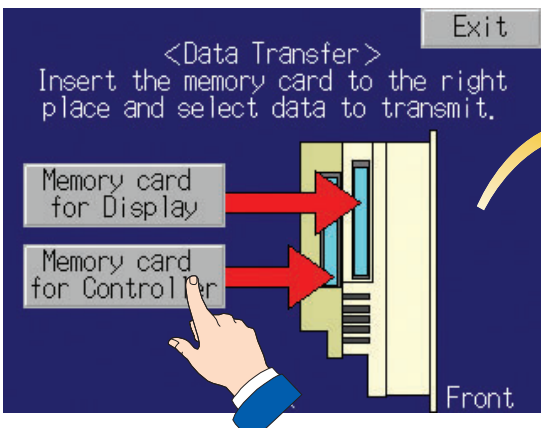

Easy-to-understand instructions are displayed for the backup procedure.

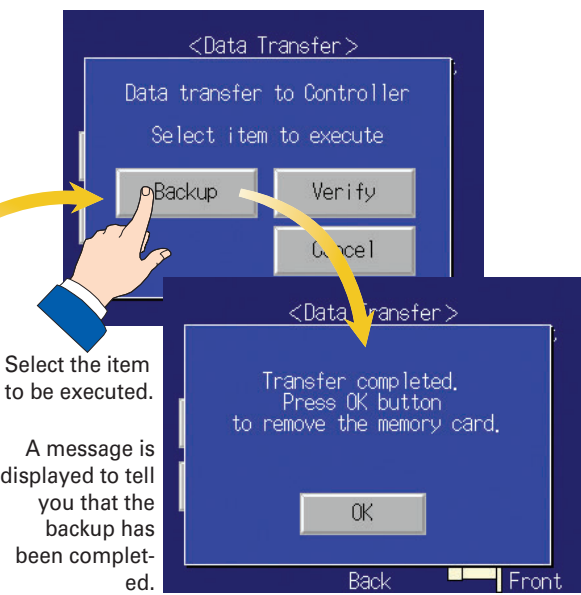

Select the item to be executed.

A message is displayed to tell you that the backup has been completed.

# Application Examples

## Production control system

Production control information is given by the host computer concerning production progress, retooling instructions, alarms, etc.

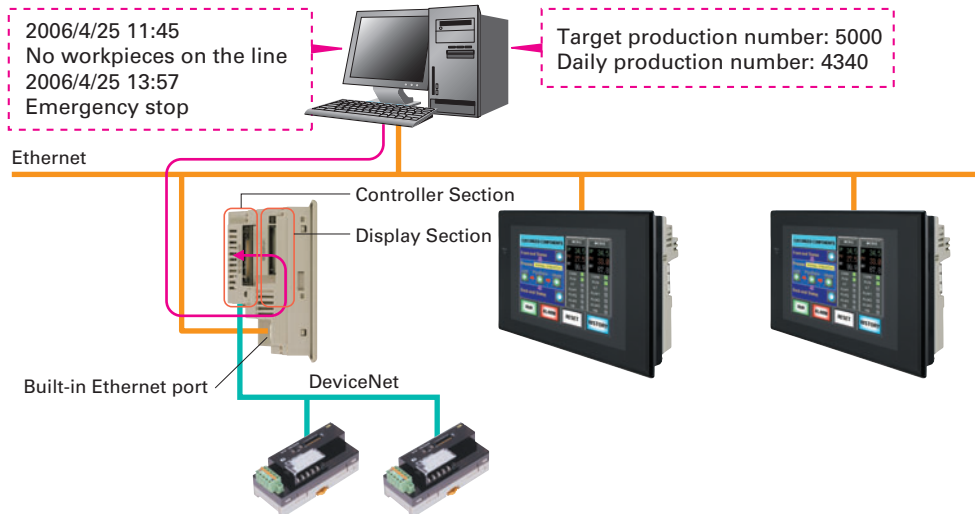

### [NSJ Series Advantages]

- Both the Display Section and Controller Section can be accessed through a single Ethernet port.
- Information for the Controller Section and Display Section (such as alarms) can be received at a host computer.
- There is no need to make initial settings for the Display Section or Controller Section.
- Using the built-in Ethernet port eliminates the need for an Expansion Unit.

## POP system

Products are controlled by a bar code reader. Information is uploaded to a host computer for product information management.

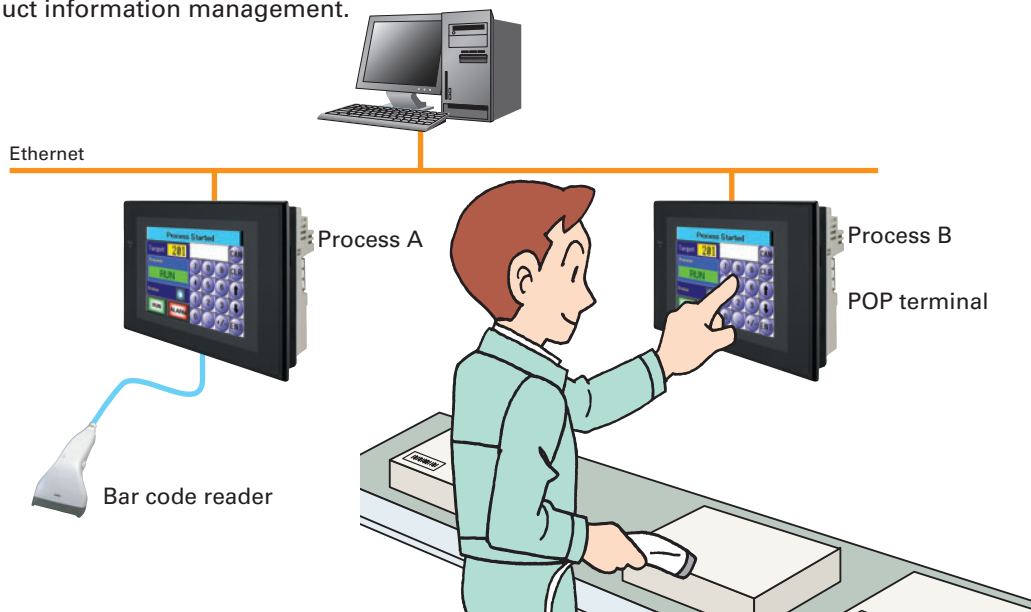

### [NSJ Series Advantages]

- The terminal can be installed anywhere since it saves space.
- Connection with the host can be made using the built-in Ethernet port.

## Simple positioning control

Simple positioning control can be achieved by connecting the NSJ to a robot controller.

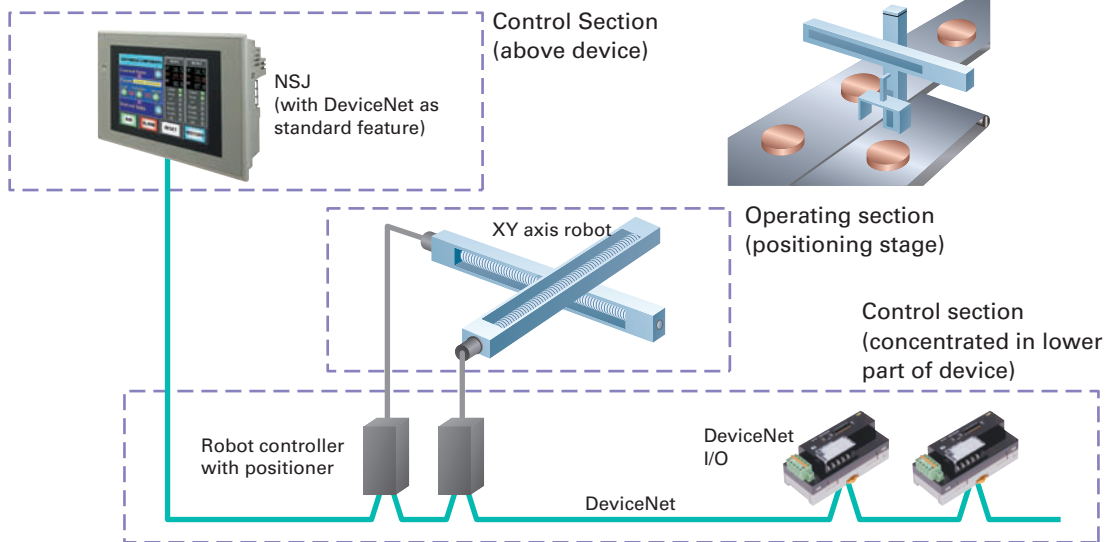

### [NSJ Series Advantages]

- Simple positioning control can be achieved with minimal wiring by directly connecting the NSJ to a robot controller.
- I/O can also be directly connected to reduce wiring.
- There is no more need for PLC space in the bottom of the control panel.

## DeviceNet monitoring

The smart functions of various slaves connected to DeviceNet can be monitored.

Example: By using a Slave Unit to count the number of ON/OFF operations for a device, or to count the total operating hours, the NSJ can inform the operator when it is time to conduct maintenance.

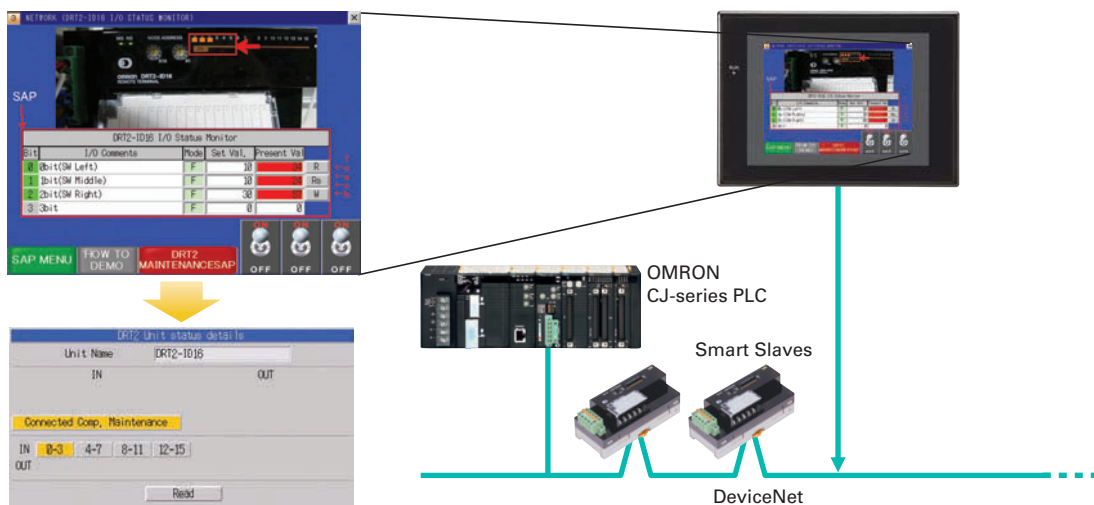

### [NSJ Series Advantages]

- Monitoring and diagnostic functions can be added to the control panel.
- Wiring and space requirements are reduced, and the NSJ can be added on later.
- The number of design steps can be reduced for screen design and ladder programming by using the Smart Active Parts (SAP) Library and troubleshooter functions.

# Suitable to a Wide Range of Applications

## System Configuration

A variety of networks can be easily constructed using the standard-equipped DeviceNet, USB, Ethernet, and RS-232C interfaces. This increases the types of equipment that can be connected to the NSJ Series in addition to the wide line-up of highly compatible OMRON control components, and provides a level of expandability that meets virtually all application needs.

- Combined use (the Display Section and Controller Section can be accessed from a single port)
- Controller Section (for use with ladder programs, etc.)
- Display Section (for directly uploading graphs or making settings)

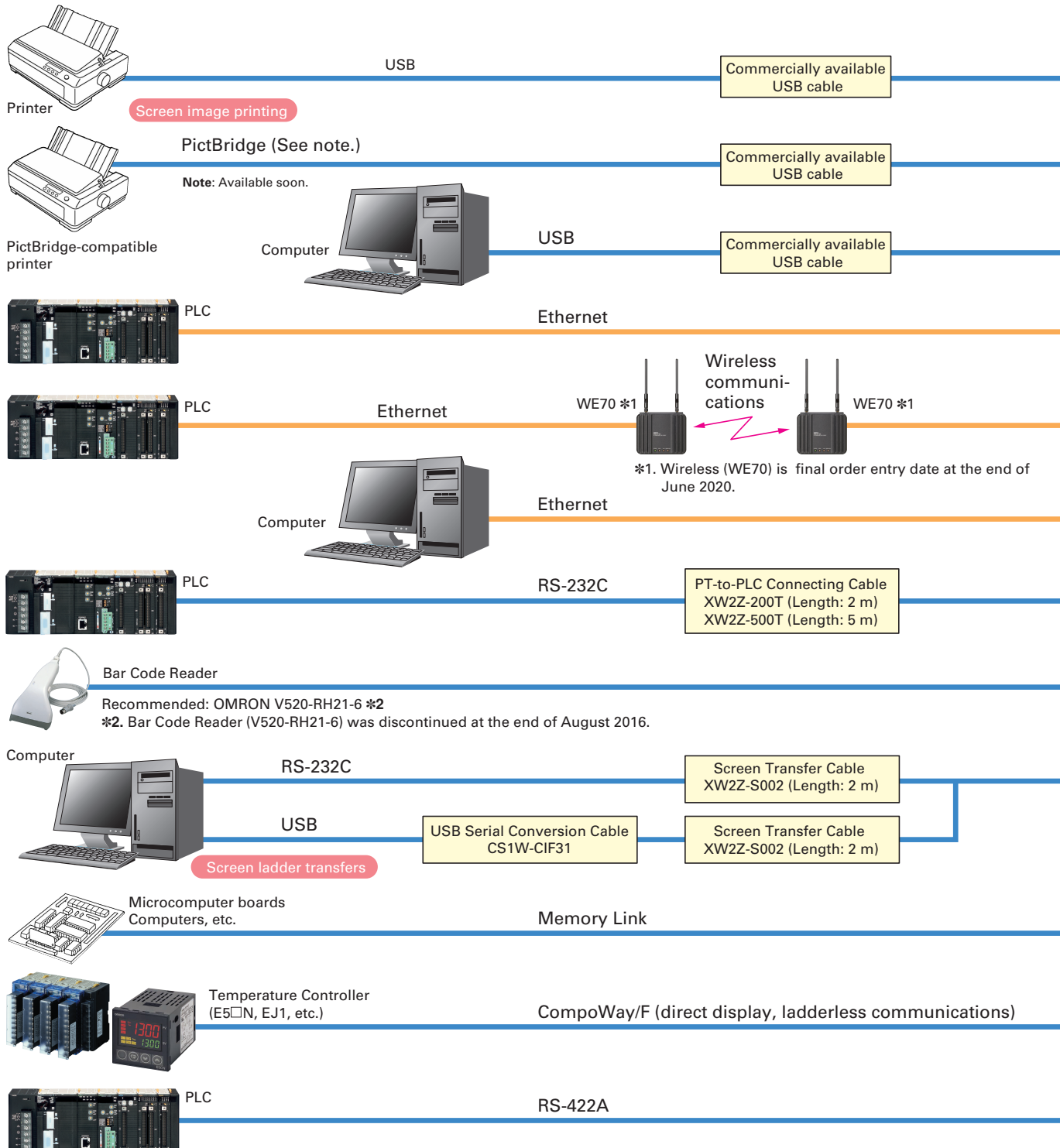



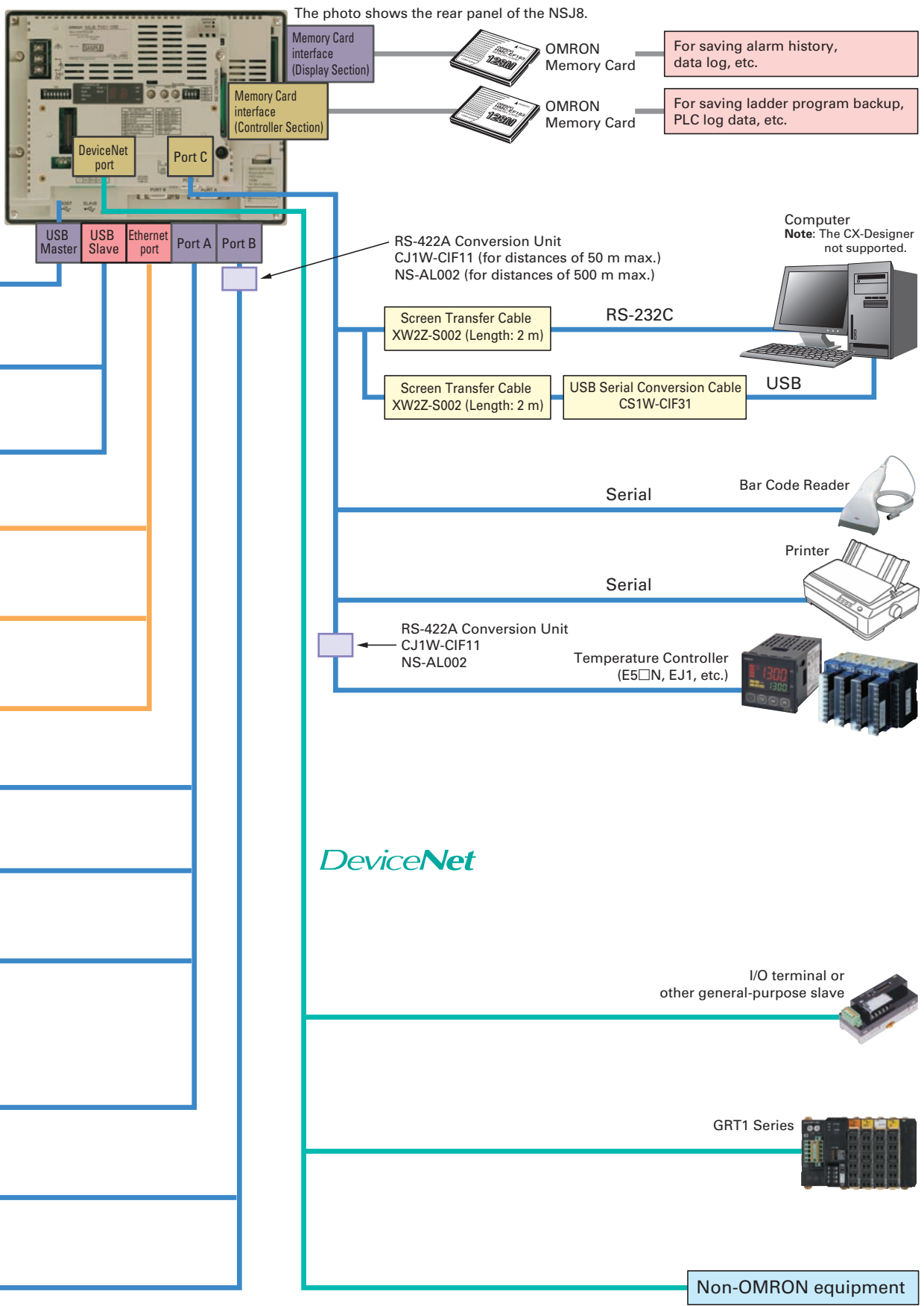



---

# Ordering Information and Specifications

---

Standard Models .....	20
■ Controllers.....	20
■ Options and Expansion Units.....	21
● Differences between the NSJ□-□□□□-G5D and NSJ□-□□□□-M3D .....	21
General Specifications.....	22
■ NSJ Controllers.....	22
■ NSJ Expansion Units .....	22
Controller Section Specifications.....	23
Display Section Specifications.....	26
Communications Section Specifications.....	27
■ DeviceNet Section .....	27
■ Controller Link (Wired).....	27
■ Ethernet Unit.....	28
■ Differences between the Built-in Ethernet and Ethernet Unit Ports .....	28
Support Software.....	29
■ Ordering Information.....	29
Dimensions.....	30

---

## ●International Standards

- The standards are abbreviated as follows: U: UL, U1: UL (Class I Division 2 Products for Hazardous Locations), C: CSA, UC: cULus, UC1: cULus (Class I Division 2 Products for Hazardous Locations), CU: cUL, N: NK, L: Lloyd, and CE: EC Directives.
- Contact your OMRON representative for further details and applicable conditions for these standards.

## ●EC Directives

The EC Directives applicable to PLCs include the EMC Directives. OMRON complies with these directives as described below.

### ●EMC Directives

Applicable Standards EMI: EN61131-2  
                                  EN61000-6-4  
                                  EMS: EN61131-2  
                                  EN61000-6-2

PLCs are electrical devices that are incorporated in machines and manufacturing installations. OMRON PLCs conform to the related EMC standards so that the devices and machines into which they are built can more easily conform to EMC standards. The actual PLCs have been checked to ensure conformity to EMC standards. Whether these standards are satisfied for the actual system, however, must be checked by the customer.

EMS-related performance will vary depending on the configuration, wiring, and other conditions of the equipment or control panel in which the PLC is installed. The customer must, therefore, perform final checks to confirm that the overall machine or device conforms to EMC standards.

**Note:** The applicable EMS standards depend on the product.

# Standard Models

## ■ Controllers

NSJ□-□□□□-G5D

Name	Controller Section							Display Section				Built-in Ethernet port	Model number	Standards
	I/O	User program memory	Data memory	Extended data memory	LD instruction execution time	Number of Expansion Racks	FB program memory (bytes)	Display device	Case color	Effective display area	Resolution			
SYSMAC One NSJ-series NSJ Controller	1280 points	60 Ksteps	128 Kwords (DM: 32 Kwords)	EM: 32 Kwords × 3 banks	0.04 μs	3	1024 KB	5.7-inch color High-luminance TFT LCD	Ivory	117.2 × 88.4 mm (W × H) (5.7 inches)	320 × 240 (QVGA)	Yes	NSJ5-TQ11-G5D	UC1, CE UL Type4
									Black				NSJ5-TQ11B-G5D	
								8.4-inch color TFT LCD	Ivory	170.9 × 128.2 mm (W × H) (8.4 inches)	640 × 480 (VGA)	Yes	NSJ8-TV01-G5D	UC1, CE
									Black				NSJ8-TV01B-G5D	
								10.4-inch color TFT LCD	Ivory	215.2 × 162.4 mm (W × H) (10.4 inches)		Yes	NSJ10-TV01-G5D	UC1, CE UL Type4
									Black				NSJ10-TV01B-G5D	
								12.1-inch color TFT LCD	Ivory	246.0 × 184.5 mm (W × H) (12.1 inches)	800 × 600 (SVGA)	Yes	NSJ12-TS01-G5D	
									Black				NSJ12-TS01B-G5D	

**Note:** Production of the NSJ□-□□□□(B)-M3D, NSJ5-SQ1□(B)-G5D, NSJ5-TQ10(B)-G5D, NSJ8-TV00(B)-G5D, NSJ10-TV00(B)-G5D and NSJ12-TS00(B)-G5D have been discontinued at the end of September 2012.

## Options and Expansion Units

Name		Specifications	Model	Standards
Expansion Units	NSJ Controller Link Unit	For increasing the number of Controller Link ports Same as the CJ1W-CLK21-V1 Controller Link Unit for the CJ Series.	NSJW-CLK21-V1	UC1, CE
	NSJ Ethernet Unit	For increasing the number of Ethernet ports Same as the CJ1W-ETN21 Ethernet Unit for the CJ Series.	NSJW-ETN21	
	NSJ I/O Control Unit	For adding CJ-series Expansion Racks. Same as the CJ1W-IC101 I/O Control Unit for the CJ Series. Use the following I/O Connecting Cables.	NSJW-IC101	
I/O Connecting Cables	For connecting CJ-series Expansion Racks.	0.3 m	CS1W-CN313	N, L, CE
		0.7 m	CS1W-CN713	
		2 m	CS1W-CN223	
		3 m	CS1W-CN323	
		5 m	CS1W-CN523	
		10 m	CS1W-CN133	
		12 m	CS1W-CN133-B2	
Memory Cards (for both Controller Section and Display Section)	Flash memory: 128 MB		HMC-EF183	N, L, CE
	Flash memory: 256 MB		HMC-EF283	
	Flash memory: 512 MB		HMC-EF583	
	Memory Card Adapter (for computer PCMCIA slot)		HMC-AP001	CE
Peripheral Device Connecting Cables for the RS-232C port	Connects computer, D-Sub 9-pin, Length: 2.0 m	Used for peripheral bus or Host Link. Anti-static connectors	XW2Z-200S-CV	---
	Connects computer, D-Sub 9-pin, Length: 5.0 m		XW2Z-500S-CV	
	Connects computer, D-Sub 9-pin, Length: 2.0 m	Used for Host Link only. Peripheral bus not supported.	XW2Z-200S-V	
	Connects computer, D-Sub 9-pin, Length: 5.0 m		XW2Z-500S-V	
RS-422A Conversion Adapter	Adapter for converting a RS-232C port to a RS-422A/485 port.	Communications distance: 500 m max.	NS-AL002	---
		Communications distance: 50 m max.	CJ1W-CIF11	
Battery life	5 years at 25°C		CJ1W-BAT01	CE

### ● Differences between the NSJ□-□□□□-G5D and NSJ□-□□□□-M3D

Function	Model	NSJ□-□□□□-G5D	NSJ□-□□□□-M3D (The following models are discontinued.)
UM capacity		60 Ksteps	20 Ksteps
I/O		1,280 points	640 points
Extended data memory		32 Kwords × 3 banks	None
EM file memory		Yes	None
Maximum number of Expansion Racks		3	1
FB program memory capacity		1024 KB	256 KB
Maximum number of FB definitions		1,024	128
Maximum number of FB instances		2,048	256
Variable table size		128 KB	64 KB

# General Specifications

## Parts Names

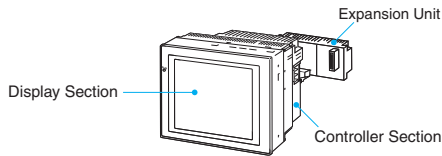

## ■NSJ Controllers

Items	Model	Specifications			
		NSJ12-TS01-G5D	NSJ10-TV01-G5D	NSJ8-TV01-G5D	NSJ5-TQ11-G5D
Supply voltage	24 VDC				
Allowable supply voltage range	20.4 to 27.6 VDC (24 VDC ±15%)				
Power consumption	30 W max.			TQ1□: 22 W max.	
Current consumption	Controller Section Internal 5 V: 500 mA max. DeviceNet Section Internal 5 V: 200 mA max., External 24 V: 18 mA max.				
Inrush current (See note 1.)	At 24 VAC: 10 A/20 ms max. for cold start at room temperature				
Ambient operating temperature (depending on angle of display surface off horizontal) (See note 2.)	90° to 60°: 0 to 50°C 60° to 30°: 0 to 45°C 30° to 0°: Use prohibited.			90° to 30°: 0 to 50°C 30° to 0°: 0 to 40°C	
Ambient storage temperature	-20 to 60°C				
Ambient operating humidity	0 to 40°C: 35% to 85% (with no condensation) 40 to 50°C: 35% to 60% (with no condensation)				
Ambient operating environment	No corrosive gases				
Insulation resistance	20 MΩ min. (at 100 VDC) between DC external and GR terminals				
Dielectric strength	800 VDC for 1 min between DC external and GR terminals, leakage current: 10 mA max.				
Noise immunity	2 kV on power supply line (conforming to IEC 61000-4-4)				
Vibration resistance (during operation)	10 to 57 Hz, 0.075-mm amplitude, 57 to 150 Hz, acceleration: 9.8 m/s <sup>2</sup> in X, Y, and Z directions for 80 minutes				
Shock resistance (during operation)	147 m/s <sup>2</sup> , 3 times each in X, Y, and Z directions				
External dimensions (See note 3.)	Without Expansion Unit	315 × 241 × 73.3 mm (W × H × D)		232 × 177 × 73.3 mm (W × H × D)	195 × 142 × 79 mm (W × H × D)
	With Expansion Unit	315 × 241 × 89.3 mm (W × H × D)		232 × 177 × 89.3 mm (W × H × D)	195 × 142 × 95 mm (W × H × D)
Panel cutout dimensions	302 <sup>+1</sup> <sub>0</sub> × 228 <sup>+1</sup> <sub>0</sub> mm (W × H) Panel thickness: 1.6 to 4.8 mm		220.5 <sup>+0.50</sup> <sub>0</sub> × 165.5 <sup>+0.50</sup> <sub>0</sub> mm (W × H) Panel thickness: 1.6 to 4.8 mm	184 <sup>+0.50</sup> <sub>0</sub> × 131 <sup>+0.5</sup> <sub>0</sub> mm (W × H) Panel thickness: 1.6 to 4.8 mm	
Grounding	100 Ω or less				
Weight	2.7 kg max.	2.5 kg max.	2.0 kg max.	1.1 kg max.	
Degree of protection	Front operating panel: Equivalent to IP65 Oil-proof type and NEMA4 (See note 4.)				Front operating panel: Equivalent to IP65 Oil-proof type, NEMA4 and UL Type 4 (See note 4.)
Battery life	5 years (at 25°C) The SRAM and RTC will be backed up for 5 days after the battery runs low (i.e., after the indicator lights orange). The SRAM and RTC will be backed up by a super capacitor for 5 minutes after removing the old battery (i.e., after turning ON power after 5 minutes).				
International standards	Conforms to cULus and EC Directives.				

**Note 1.** A delay circuit that charges a capacitor is used to limit the inrush current. If a hot start is performed when the power supply has been OFF only a short period of time, the capacitor will still be charged and the inrush current specified above will be exceeded by up to approximately five times the specified value.

When selecting fuses or breakers for external circuits, allow sufficient margin in the melting temperatures, detection characteristics, and inrush current

**Note 2.** Display angles off horizontal are as follows:

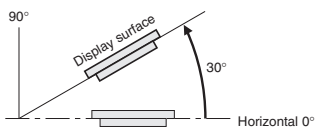

**Note 3.** For detailed information, refer to "Dimensions" on page 30.

**Note 4.** May not be applicable in locations with long-term exposure to oil.

## ■NSJ Expansion Units

### Controller Link Unit

Item	Specifications
Model	NSJW-CLK21-V1
Current consumption	300 mA
Weight	100 g max.

**Note:** Other general specifications are the same as the NSJ Controller.

### I/O Control Unit

Item	Specifications
Model	NSJW-IC101
Current consumption	20 mA
Weight	100g max.

**Note:** Other general specifications are the same as the NSJ Controller.

### Ethernet Unit

Item	Specifications
Model	NSJW-ETN21
Current consumption	370 mA
Weight	100 g max.

**Note:** Other general specifications are the same as the NSJ Controller.

# Controller Section Specifications

Item		Specifications
Control method		Stored program
I/O control method		Cyclic scan and immediate processing are both possible.
Programming		Ladder diagram
CPU processing modes		Normal Mode, Parallel Processing Mode with Asynchronous Memory Access, Parallel Processing Mode with Synchronous Memory Access, and Peripheral Servicing Priority Mode
Instruction length		1 to 7 steps per instruction
Ladder instructions		Approx. 400 (3-digit function codes)
Execution time	Basic instructions	0.04 µs min.
	Special instructions	0.06 µs min.
Overhead time		Normal mode: 0.3 ms Parallel processing: 0.3 ms
Installation		Installed using Panel Mounting Bracket.
Mountable Expansion Units		One of the following can be mounted as an Expansion Unit: <ul style="list-style-type: none"> <li>• NSJ I/O Control Unit (NSJW-IC101)</li> <li>• NSJ Controller Link Unit (NSJW-CLK21-V1)</li> <li>• NSJ Ethernet Unit (NSJW-ETN21)</li> </ul>
Maximum number of Expansion Racks		<ul style="list-style-type: none"> <li>• With the NSJW-IC101 I/O Control Unit mounted, a maximum of three CJ-series Expansion Racks can be used with the NSJ□-□□□□(B)-G5D.</li> <li>• A CJ-series CJ1W-II101 Interface Unit and Power Supply Unit are required for each Expansion Rack.</li> </ul>
Maximum number of connectable Units		<ul style="list-style-type: none"> <li>• Per Expansion Rack: 10 Units max. (Basic I/O Units, Special I/O Units, or CPU Bus Units)</li> <li>• A maximum of 30 Units (10 Units on CJ-series Expansion Rack × 3) can be mounted to the entire NSJ□-□□□□(B)-G5D system.</li> </ul>
Number of tasks		288 (cyclic tasks: 32, interrupt tasks: 256) Interrupt tasks can be defined as cyclic tasks called "extra cyclic tasks." Including these, up to 288 cyclic tasks can be used. <b>Note 1.</b> Cyclic tasks are executed each cycle and are controlled with TKON(820) and TKOF(821) instructions. <b>Note 2.</b> The following 3 types of interrupt tasks are supported: Power OFF interrupt task: 1 max., Scheduled interrupt tasks: 2 max., External interrupt tasks: 256 max.
Interrupt types		Scheduled Interrupts: Interrupts generated at a time scheduled by the Controller Section's built-in timer. (See note. 1) Power OFF Interrupt (See note 2.): Interrupt executed when the Controller Section's power is turned OFF. External I/O Interrupts: Interrupts from the Special I/O Units or CPU Bus Units. <b>Note 1.</b> Scheduled interrupt time interval is either 1 ms to 9,999 ms or 10 ms to 99,990 ms, in units of 1 ms or 10 ms. <b>Note 2.</b> Not supported when the CJ1W-PD022 Power Supply Unit is mounted.
Calling subroutines from more than one task		Supported using global subroutines.
Function blocks		Languages supported in function block definitions: Ladder programming language and structured text
CIO (Core I/O) Area	I/O Area	2,560 (160 words): CIO 00000 to CIO 015915 (words CIO 0000 to CIO 0159) The setting of the first rack word can be changed from the default (CIO 0000) so that CIO 0000 to CIO 0999 can be used. I/O bits are allocated to Basic I/O Units.
	Link Area	3,200 (200 words): CIO 10000 to CIO 119915 (words CIO 1000 to CIO 1199)
	CPU Bus Unit Area	6,400 (400 words): CIO 150000 to CIO 189915 (words CIO 1500 to CIO 1899) CPU Bus Unit bits store operating status of CPU Bus Units. (25 words per Unit, 16 Units max.)
	Inner Board Area	1,600 (100 words): CIO 190000 to CIO 199915 (words CIO 1900 to CIO 1999) Bits in the Inner Board Area are allocated to the display status area.
	C200H Special I/O Unit Area	15,360 (960 words): CIO 200000 to CIO 295915 (words CIO 2000 to CIO 2959) Bits in the Special I/O Area can be allocated to Special I/O Units (10 words per Unit, 96 Units max.)
	DeviceNet Area	9,600 (600 words): CIO 320000 to CIO 379915 (words CIO 3200 to CIO 3799) DeviceNet bits are allocated to Slaves for DeviceNet Section remote I/O communications when the master function is used with fixed allocations. Fixed allocation setting 1 Outputs: CIO 3200 to CIO 3263 Inputs: CIO 3300 to CIO 3363 Fixed allocation setting 2 Outputs: CIO 3400 to CIO 3463 Inputs: CIO 3500 to CIO 3563 Fixed allocation setting 3 Outputs: CIO 3600 to CIO 3663 Inputs: CIO 3700 to CIO 3763 <b>Note:</b> The following words are allocated to the master function even when the DeviceNet Unit is used as a slave. Fixed allocation setting 1 Outputs: CIO 3370 (master to slave) Inputs: CIO 3270 (slave to master) Fixed allocation setting 2 Outputs: CIO 3570 (master to slave) Inputs: CIO 3470 (slave to master) Fixed allocation setting 3 Outputs: CIO 3770 (master to slave) Inputs: CIO 3670 (slave to master)
Work bits	CIO (Core I/O) Area	4,800 (300 words): CIO 120000 to CIO 149915 (words CIO 1200 to CIO 1499) 37,504 (2,344 words): CIO 380000 to CIO 614315 (words CIO 3800 to CIO 6143) These bits in CIO Area are used as work bits in programming to control program execution. They cannot be used for external I/O.
	Work Area	8,192 bits (512 words): W00000 to W51115 (words W000 to W511) Control programs only. (I/O from external I/O terminals is not possible.) <b>Note:</b> When using work bits in programming, use bits in Work Area first before using bits from other areas.
Holding Area		8,192 bits (512 words): H00000 to H51115 (words H000 to H511) Holding bits are used to control execution of program, and maintain their ON/OFF status when the PLC is turned OFF or operating mode is changed. <b>Note:</b> Words H512 to H1535 are allocated to the Function Block Holding Area and are used only for the function block instance area (internally allocated variable area).
Auxiliary Area		Read only: 7,168 bits (448 words): A00000 to A44715 (words A000 to A447) Read/write: 8,192 bits (512 words): A44800 to A95915 (words A448 to A959) Auxiliary bits are allocated specific functions.

The CIO Area can be used as work bits if the bits are not used as shown here.

# Controller Section Specifications

Item		Specifications		
Temporary Area		16 bits (TR00 to TR15) Temporary bits are used to store ON/OFF execution conditions at program branches.		
Timer Area		4,096: T0000 to T4095 (used for timers only)		
Counter Area		4,096: C0000 to C4095 (used for counters only)		
DM Area		32 Kwords: D00000 to D32767		
		Special I/O Unit DM Area: D20000 to D29599 (100 words × 96 Units).	Used to set parameters for Special I/O Units.	
		CPU Bus Unit DM Area: D30000 to D31599 (100 words × 16 Units).	Used to set parameters for CPU Bus Units.	
EM Area		<p>NSJ□-□□□□(B)-G5D:            32 Kwords per bank, 3 banks max.: E0_00000 to E2_32767 max.            Used as a general-purpose data area for reading and writing data in word units (16 bits). Words in EM Area maintain their status when the NSJ Controller is turned OFF or operating mode is changed.            The EM Area is divided into banks, and addresses can be set by either of following methods.            Changing current bank using the EMBC (281) instruction and setting addresses for the current bank.            Setting bank numbers and addresses directly.            EM data can be stored in files by specifying number of first bank. (EM file memory)</p>		
Index Registers		IR0 to IR15. Store actual memory addresses for indirect addressing. Index registers can be used independently in each task. One register is 32 bits (2 words). Index registers can be specified as shared or independent for each task.		
Task Flag Area		32 (TK0000 to TK0031). Task Flags are read-only flags that are ON when corresponding cyclic task is executable and OFF when corresponding task is not executable or in standby status.		
Trace Memory		4,000 words (traceable data: 31 bits and 6 words)		
File Memory		<p>Memory Cards: Compact flash memory cards can be used (MS-DOS format).            EM file memory: Part of EM Area can be converted to file memory (MS-DOS format).            The NSJ□-□□□□(B)-M3D does not support EM file memory.</p>		
Functions	Constant cycle time	1 to 32,000 ms (Unit: 1 ms) <b>Note:</b> Using the Parallel Processing Mode will create a constant cycle time for program execution.		
	Cycle time monitoring	Possible (Unit stops operating if cycle is too long): 10 to 40,000 ms (Unit: 10 ms) <b>Note:</b> When the Parallel Processing Mode is used, the program execution cycle is monitored. Controller Section operation will stop if the peripheral servicing time exceeds 2 s.		
	I/O refreshing	Cyclic refreshing, immediate refreshing, refreshing by IORF(097). <b>Note:</b> IORF(097) refreshes I/O bits allocated to Basic I/O Units and Special I/O Units. The CPU BUS UNIT I/O REFRESH (DLNK(226)) instruction can be used to refresh bits allocated to CPU Bus Units in the CIO and DM Areas.		
	Timing of refreshing for CPU Bus Units	Data links for Control Link Units, remote I/O communications for DeviceNet Units, and other special data for CPU Bus Units is refreshed at the following times. During I/O refresh period or when CPU BUS UNIT I/O REFRESH (DLNK(226)) instruction is executed.		
	I/O memory holding when changing operating modes	Depends on ON/OFF status of IOM Hold Bit in Auxiliary Area.		
	Load OFF	All outputs on Output Units can be turned OFF when the Controller Section is operating in RUN, MONITOR, or PROGRAM mode.		
	Timer/counter PV refresh method	BCD or binary (CX-Programmer version 3.0 or higher)		
	Input time constant setting	Time constants can be set for inputs from CJ-series Basic I/O Units. The time constant can be increased to reduce influence of noise and chattering or it can be decreased to detect shorter pulses on inputs.		
	Mode setting at power-up	The operating mode can be specified.		
	Flash memory	<ul style="list-style-type: none"> <li>The user program and parameter area data (e.g., PLC Setup) are always backed up automatically in flash memory. (automatic backup and restore.)</li> <li>When downloading projects from CX-Programmer Ver. 5.0 or higher, symbol table files (including CX-Programmer symbol names, I/O comments), comment files (CX-Programmer rung comments, other comments), and program index files (CX-Programmer section names, section comments, or program comments) are stored in comment memory within the flash memory.</li> </ul>		
	Memory Card functions (Controller Section)	Automatically reading programs (autoboot) from the Memory Card when the power is turned ON.	Possible	
		Program replacement during Controller Section operation	Possible	
		Memory Card storage data	User program: Program file format PLC Setup and other parameters: Data file format I/O memory: Data file format (binary), text format, CSV format	
		Memory Card read/write method	User program instructions, Programming Devices (including CX-Programmer and Programming Console), Host Link computers, Auxiliary Area control bits, easy backup operation	
Filing (Controller Section)	Memory Card data and EM (Extended Data Memory) Area can be handled as files.			
Debugging	Force-set/reset, differential monitoring, data tracing (scheduled, each cycle, or when instruction is executed), storing location generating error.			



# Controller Section Specifications

Item		Specifications				
Functions	Online editing	User programs can be overwritten in program block units when the Controller Section is in MONITOR or PROGRAM mode. This function is not supported for block programming areas. With the CX-Programmer, more than one program block can be edited at the same time.				
	Program protection	Overwrite protection: Set using DIP switch or via the password from CX-Programmer peripheral device. Copy protection: Password set using CX-Programmer.				
	Error check	User-defined errors (i.e., user can define fatal errors and non-fatal errors) The FPD(269) instruction can be used to check execution time and logic of each programming block. <b>Note:</b> FAL and FALS instructions can be used to simulate errors.				
	Error log	Up to 20 errors are stored in error log. Information includes error code, error details, and time error occurred. <b>Note:</b> The Controller Section can be set so that user-defined FAL errors are not stored in the error log.				
	Clock	Provided on all models. Accuracy: <table border="1" data-bbox="475 517 885 577"> <thead> <tr> <th>Ambient temperature</th> <th>Monthly variation</th> </tr> </thead> <tbody> <tr> <td>25°C</td> <td>-1.5 to +1.5 min</td> </tr> </tbody> </table> <b>Note 1.</b> Accuracy varies with the temperature. <b>Note 2.</b> Used to store time when power is turned ON and when errors occur.	Ambient temperature	Monthly variation	25°C	-1.5 to +1.5 min
	Ambient temperature	Monthly variation				
	25°C	-1.5 to +1.5 min				
	Power OFF detection time	2 ms				
	Power OFF detection delay time	0 ms fixed				
	Memory protection	Held Areas: Holding bits, Data Memory, Extended Data Memory, and status of counter Completion Flags and present values. <b>Note:</b> If IOM Hold Bit in Auxiliary Area is turned ON, and PLC Setup is set to maintain IOM Hold Bit status when power to the NSJ Controller is turned ON, contents of CIO Area, Work Area, part of Auxiliary Area, timer Completion Flag and present values, Index Registers, and Data Registers will be saved.				
	Sending commands to a Host Link computer	FINS commands can be sent to a computer connected via Host Link System by executing Network Communications Instructions from the Controller Section.				
	Remote programming and monitoring	Host Link communications can be used for remote programming and remote monitoring through a Controller Link System or Ethernet network.				
	Eight-level communications	Host Link communications can be used for remote programming and remote monitoring from devices on networks up to eight levels away (Controller Link Network, Ethernet Network, or other network).				
	Storing comments in CPU Unit	I/O comments can be stored as symbol table files in Memory Cards in the Controller Section, EM file memory, or Comment Memory (see note). <b>Note:</b> Supported for CX-Programmer Ver. 5.0 or later only.				
Program check	Program checks are performed at the beginning of operation for items such as no END(001) instruction and instruction errors. CX-Programmer can also be used to check programs.					
Battery life	5 years at 25°C (The battery life depends on the ambient operating temperature; 1.1 years min.) (Battery set: CJ1W-BAT01; Use a Replacement Battery that is within two years of its date of manufacture.)					
Self-diagnostics	Controller Section errors (watchdog timer), I/O bus errors, memory errors, and battery errors					
Other functions	Storage of number of times power has been interrupted. (Stored in A514.)					

# Display Section Specifications

Model	Built-in ports					Display Section			
	USB port (Slave: For Support Software)	RS-232C port	DeviceNet port	Ethernet port	USB port (Host: For printer)	Display color	Field of view	Language	Standard screen data capacity
NSJ5-TQ11-G5D	1 port	3 ports •Display Section: Serial ports A, B •Controller Section: Serial port	1 port	10/ 100Base-T	None	256 colors (BMP/JPEG, 32,768 colors for images)	Right/left: ±80°, Top: 80°, Bottom: 60° (See note 1.)	Eight languages (See note 2.)	60 MB
NSJ5-TQ11B-G5D				10/ 100Base-T	1 port		Right/left: ±80°, Top: 80°, Bottom: 60° (See note 1.)		
NSJ8-TV01-G5D							10/ 100Base-T		
NSJ8-TV01B-G5D				10/ 100Base-T	Right/left: ±80°, Top: 80°, Bottom: 80° (See note 1.)				
NSJ10-TV01-G5D				10/ 100Base-T					
NSJ10-TV01B-G5D									
NSJ12-TS01-G5D									
NSJ12-TS01B-G5D									

**Note 1.** LotNo.15Z10 or later of NS5 models, LotNo. 28X11 or later of NS8 models, LotNo. 11Y11 or later of NS10 models, LotNo. 14Y11 or later of NS12 models.

**Note 2.** Japanese, English, Chinese (traditional and simplified), Spanish, Italian, German, and French.

# Communications Section Specifications

## ■ DeviceNet Section

Item	Specifications																
Communications protocol	DeviceNet																
DeviceNet master/slave	Can function as master or slave.																
Connection forms (See note 1.)	Combination of multi-drop and T-branch connections (for trunk or branch lines)																
Terminating resistance.	SW4 (TER) is used to connect/disconnect terminating resistance. The TER indicator lights when terminating resistance is connected.																
Baud rate	500 kbps, 250 kbps, or 125 kbps (Set via DIP switch.)																
Communications distances	<table border="1"> <thead> <tr> <th>Baud rate</th> <th>Network length</th> <th>Branch line length</th> <th>Total branch line length</th> </tr> </thead> <tbody> <tr> <td>500 kbps</td> <td>100 m max.</td> <td>6 m max.</td> <td>39 m max.</td> </tr> <tr> <td>250 kbps</td> <td>250 m max. (See note 2.)</td> <td>6 m max.</td> <td>78 m max.</td> </tr> <tr> <td>125 kbps</td> <td>500 m max. (See note 2.)</td> <td>6 m max.</td> <td>156 m max.</td> </tr> </tbody> </table>	Baud rate	Network length	Branch line length	Total branch line length	500 kbps	100 m max.	6 m max.	39 m max.	250 kbps	250 m max. (See note 2.)	6 m max.	78 m max.	125 kbps	500 m max. (See note 2.)	6 m max.	156 m max.
	Baud rate	Network length	Branch line length	Total branch line length													
	500 kbps	100 m max.	6 m max.	39 m max.													
	250 kbps	250 m max. (See note 2.)	6 m max.	78 m max.													
125 kbps	500 m max. (See note 2.)	6 m max.	156 m max.														
Max. number of Slaves	63 Slaves																
Error control	CRC error check, node address redundancy check, scan list verification																
Cable	Special 5-wire cable (2 signal lines, 2 power lines, 1 shield line)																

**Note 1.** Terminating resistance is required at both ends of the trunk line.

**Note 2.** Communications distances are for Thick Cables. Keep the maximum network length to 100 m or less when using Thin Cables.

## ■ Controller Link (Wired)

Item	Specifications
Communications method	N: N token bus
Code	Manchester code
Modulation	Baseband code
Synchronization	Flag synchronization (conforms to HDLC frames)
Error control	Manchester code checks and CRC checks (CCITT $X^{16}+X^{12}+X^5+1$ )
Transmission path form	Multi-drop bus
Baud rate and maximum transmission distance	The maximum transmission distance varies with the baud rate as follows: 2 Mbps: 500 m 1 Mbps: 800 m 500 Kbps: 1 km
Media	Specified shielded twisted-pair cable Number of signal lines: 2, shield line: 1
Node connection method	NSJ Controller Link Unit: Connected via a special connector (included) PLC: Connected to a terminal block IBM PC/AT or compatible: Connected via a special connector (included)
Maximum number of nodes	32 or 62 nodes (See note 1.)
Communications functions	Data links and message service
Number of data link words	<ul style="list-style-type: none"> <li>• Transmission area per node: 1,000 words max.</li> <li>• Data link area (send/receive words) per node NSJ Controller: 20,000 words CS/CJ Series: 20,000 words max. (unit Ver. 1.2 or later) 12,000 words max. (pre-Ver. 1.2) SYSMAC <math>\alpha</math>, CVM1/CV, CQM1H: 8,000 words max. Personal computer: 32,000 or 62,000 words max. (See note 2.)</li> </ul>
Data link areas	Bit-access areas (IR, AR, LR, CIO), DM Area (DM), and extended DM Area (EM)
Message length	2,012 bytes max. (including the header)
RAS functions	<ul style="list-style-type: none"> <li>• Polling node backup function</li> <li>• Self-diagnosis function (hardware checking at startup)</li> <li>• Echoback test and broadcast test (using the FINS command)</li> <li>• Watchdog timer</li> <li>• Error log function</li> </ul>

**Note 1.** At least one Repeater Unit (CS1W-RPT01) is required to construct networks that uses a node address higher than 32. The following Controller Link Units/Support Boards must also be used, and the Wired Network 62 Node Enable Bit of the DM Parameter Area software switch of all nodes must be turned ON (62 nodes max.).  
CS1W-CLK23, CJ1W-CLK23, 3G8F7-CLK23, and NSJW-CLK21-V1

**Note 2.** For a maximum configuration of 62 nodes

For other specifications, refer to the Controller Link Unit Operation Manual (Cat. No. W309).

# Communications Section Specifications

## ■Ethernet Unit

Item	Specifications	
Type	100Base-TX (can be used as 10Base-T)	
Media access method	CSMA/CD	
Modulation method	Baseband	
Transmission paths	Star form	
Baud rate	100 Mbps (100Base-TX)	100 Mbps (10Base-T)
Transmission media	Unshielded twisted-pair (UTP) cable Categories: 5, 5e Shielded twisted-pair (STP) cable Categories: 100 Ω at 5, 5e	Unshielded twisted-pair (UTP) cable Categories: 3, 4, 5, 5e Shielded twisted-pair (STP) cable Categories: 100 Ω at 3, 4, 5, 5e
Transmission distance	100 m (distance between hub and node)	
Number of cascade connections	2	4
Functions	<ul style="list-style-type: none"> <li>• FINS communications service</li> <li>• Socket services (UDP/TCP)</li> <li>• FTP server</li> <li>• Email send/receive</li> <li>• Automatic clock adjustment</li> </ul>	

**Note:** Refer to the Ethernet Units Construction of Networks Operation Manual (Cat. No. W420) and the Ethernet Units Construction of Applications Operation Manual (Cat. No. W421) for other specifications.

## ■Differences between the Built-in Ethernet and Ethernet Unit Ports

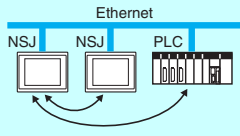
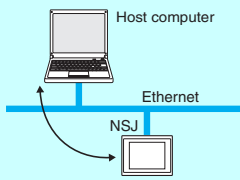
	Built-in Ethernet port	Ethernet Unit port
<p>Communications with another host (PLC)</p> 	<p>Communications is possible with another host via Ethernet. For example, from one NSJ Controller, data can be displayed or settings can be made to another NSJ Controller or PLC.</p>	<p>Same functions as at left.</p>
<p>Connection with a host computer</p> 	<p>■<b>Support Software Connections</b> CX-One (CX-Programmer, CX-Designer, etc.) can be used via Ethernet. Screen data and ladder programs can be transferred from a host computer.</p> <p>■<b>Access to a Memory Card in the Display Section</b> A memory card in the Display Section can be accessed using Support Software or FTP and Ethernet. For example, Display Section recipe data and alarm or data log files can be downloaded from a host computer.</p> <p>■<b>Access to the Host from a Host Application</b> A host computer can access the Controller Section using FINS communications. For example, an application on a host computer can read or data can be written to the NSJ data memory (DM) (UDP only).</p>	<p>Same functions as at left, plus the following:</p> <ul style="list-style-type: none"> <li>• A Memory Card in the Controller Section can be accessed.</li> <li>• The clock can be set using SNTP</li> <li>• TCP/IP support (See note.)</li> </ul> <p>(The Memory Card in the Display Section cannot be accessed.)</p> <p><b>Note:</b> Ethernet (FINS/TCP) not supported by CX-Programmer.</p>
E-mail	---	E-mail can be sent and received.
Communications using ladder programming	---	<ul style="list-style-type: none"> <li>• Socket communications are possible using the CMND instruction.</li> <li>• SEND/RCV instructions</li> </ul>

## ■ Ordering Information

Product name	Specifications	Number of licenses	Media	Model	Standards
FA Integrated Tool Package CX-One Ver.4.□	<p>The CX-One is a comprehensive software package that integrates Support Software for OMRON PLCs and components.</p> <p>CX-One runs on the following OS.                      Windows 7 (32-bit/64-bit version) /                      Windows 8 (32-bit/64-bit version) /                      Windows 8.1 (32-bit/64-bit version) /                      Windows 10 (32-bit/64-bit version)</p> <p>CX-One Ver.4.□ includes CX-Designer Ver.3.□.                      For details, refer to the <i>CX-One catalog</i> (Cat. No. R134).</p>	1 licence (See note.)	DVD	CXONE-AL01D-V4	---

**Note:** Multi licenses (3, 10, 30, or 50 licenses) and DVD media without licenses are also available for the CX-One.

# Dimensions

(Unit: mm)

## NSJ12-TS01(B)-G5D

## NSJ10-TV01(B)-G5D

With NSJW-CLK21-V1 Mounted

No Expansion Unit

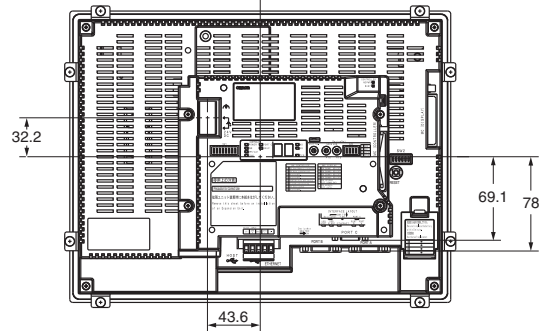
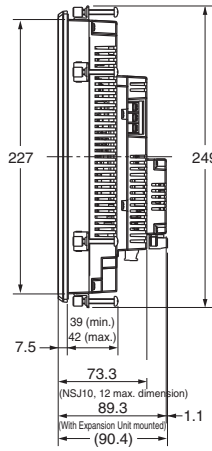
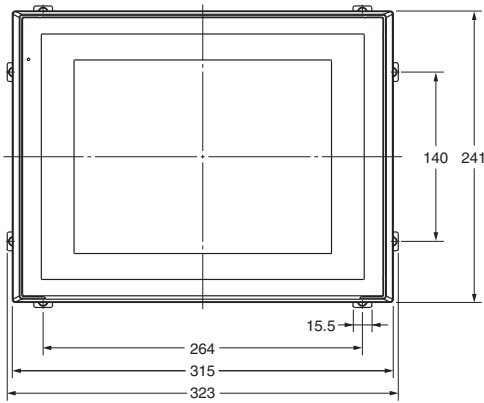

## NSJ8-TV01(B)-G5D

With NSJW-CLK21-V1 Mounted

No Expansion Unit

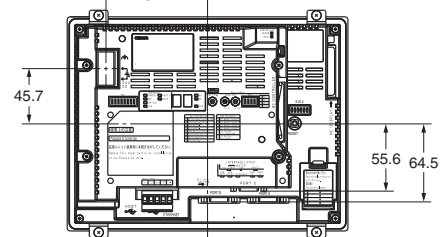
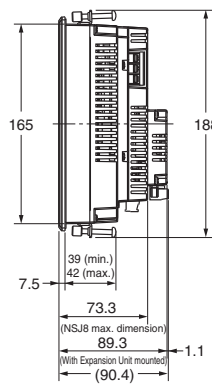
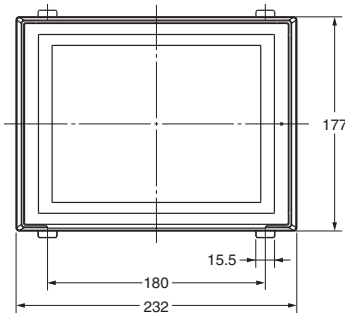

## NSJ5-TQ11(B)-G5D

With NSJW-CLK21-V1 Mounted

No Expansion Unit

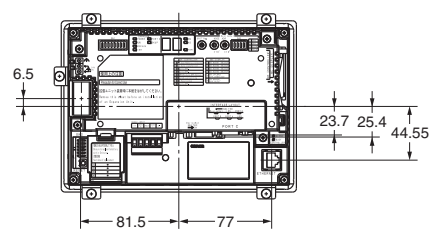
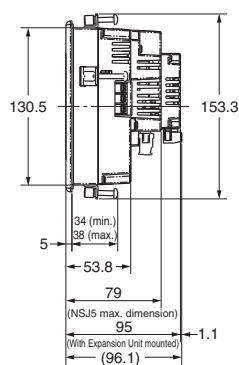
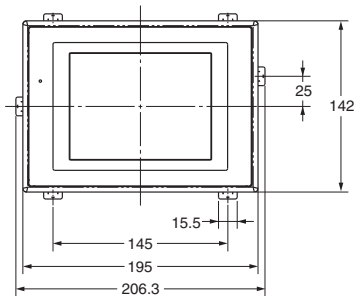

## Read and Understand this Catalog

Please read and understand this catalog before purchasing the product. Please consult your OMRON representative if you have any questions or comments.

## Warranty and Limitations of Liability

### WARRANTY

OMRON's exclusive warranty is that the products are free from defects in materials and workmanship for a period of one year (or other period if specified) from date of sale by OMRON.

OMRON MAKES NO WARRANTY OR REPRESENTATION, EXPRESS OR IMPLIED, REGARDING NON-INFRINGEMENT, MERCHANTABILITY, OR FITNESS FOR PARTICULAR PURPOSE OF THE PRODUCTS. ANY BUYER OR USER ACKNOWLEDGES THAT THE BUYER OR USER ALONE HAS DETERMINED THAT THE PRODUCTS WILL SUITABLY MEET THE REQUIREMENTS OF THEIR INTENDED USE. OMRON DISCLAIMS ALL OTHER WARRANTIES, EXPRESS OR IMPLIED.

### LIMITATIONS OF LIABILITY

OMRON SHALL NOT BE RESPONSIBLE FOR SPECIAL, INDIRECT, OR CONSEQUENTIAL DAMAGES, LOSS OF PROFITS, OR COMMERCIAL LOSS IN ANY WAY CONNECTED WITH THE PRODUCTS, WHETHER SUCH CLAIM IS BASED ON CONTRACT, WARRANTY, NEGLIGENCE, OR STRICT LIABILITY.

In no event shall the responsibility of OMRON for any act exceed the individual price of the product on which liability is asserted.

IN NO EVENT SHALL OMRON BE RESPONSIBLE FOR WARRANTY, REPAIR, OR OTHER CLAIMS REGARDING THE PRODUCTS UNLESS OMRON'S ANALYSIS CONFIRMS THAT THE PRODUCTS WERE PROPERLY HANDLED, STORED, INSTALLED, AND MAINTAINED AND NOT SUBJECT TO CONTAMINATION, ABUSE, MISUSE, OR INAPPROPRIATE MODIFICATION OR REPAIR.

## Application Considerations

### SUITABILITY FOR USE

OMRON shall not be responsible for conformity with any standards, codes, or regulations that apply to the combination of products in the customer's application or use of the products.

Take all necessary steps to determine the suitability of the product for the systems, machines, and equipment with which it will be used.

Know and observe all prohibitions of use applicable to this product.

NEVER USE THE PRODUCTS FOR AN APPLICATION INVOLVING SERIOUS RISK TO LIFE OR PROPERTY WITHOUT ENSURING THAT THE SYSTEM AS A WHOLE HAS BEEN DESIGNED TO ADDRESS THE RISKS, AND THAT THE OMRON PRODUCTS ARE PROPERLY RATED AND INSTALLED FOR THE INTENDED USE WITHIN THE OVERALL EQUIPMENT OR SYSTEM.

### PROGRAMMABLE PRODUCTS

OMRON shall not be responsible for the user's programming of a programmable product, or any consequence thereof.

## Disclaimers

### CHANGE IN SPECIFICATIONS

Product specifications and accessories may be changed at any time based on improvements and other reasons.

It is our practice to change model numbers when published ratings or features are changed, or when significant construction changes are made. However, some specifications of the products may be changed without any notice. When in doubt, special model numbers may be assigned to fix or establish key specifications for your application on your request. Please consult with your OMRON representative at any time to confirm actual specifications of purchased products.

### DIMENSIONS AND WEIGHTS

Dimensions and weights are nominal and are not to be used for manufacturing purposes, even when tolerances are shown.

### PERFORMANCE DATA

Performance data given in this catalog is provided as a guide for the user in determining suitability and does not constitute a warranty. It may represent the result of OMRON's test conditions, and the users must correlate it to actual application requirements. Actual performance is subject to the OMRON Warranty and Limitations of Liability.

**Note: Do not use this document to operate the Unit.**

**OMRON Corporation Industrial Automation Company**  
Tokyo, JAPAN

Contact: [www.ia.omron.com](http://www.ia.omron.com)

**Regional Headquarters**

**OMRON EUROPE B.V.**

Wegalaan 67-69-2132 JD Hoofddorp  
The Netherlands  
Tel: (31)2356-81-300/Fax: (31)2356-81-388

**OMRON ELECTRONICS LLC**

One Commerce Drive Schaumburg,  
IL 60173-5302 U.S.A.  
Tel: (1) 847-843-7900/Fax: (1) 847-843-7787

**OMRON ASIA PACIFIC PTE. LTD.**

No. 438A Alexandra Road # 05-05/08 (Lobby 2),  
Alexandra Technopark,  
Singapore 119967  
Tel: (65) 6835-3011/Fax: (65) 6835-2711

**OMRON (CHINA) CO., LTD.**

Room 2211, Bank of China Tower,  
200 Yin Cheng Zhong Road,  
PuDong New Area, Shanghai, 200120, China  
Tel: (86) 21-5037-2222/Fax: (86) 21-5037-2200

**Authorized Distributor:**

© OMRON Corporation 2006-2020 All Rights Reserved.  
In the interest of product improvement,  
specifications are subject to change without notice.

**CSM\_7\_7**

**Cat. No. V406-E1-07**

0820 (1206)