

GaAs pHEMT MMIC MEDIUM POWER AMPLIFIER, 6 - 18 GHz

Typical Applications

The HMC441LC3B is ideal for use as a medium power amplifier for:

- Point-to-Point Radios
- Point-to-Multi-Point Radios & VSAT
- LO Driver for HMC Mixers
- Military EW & ECM

Features

- Gain: 14 dB
- Saturated Output Power: +21.5 dBm @ 27% PAE
- Single Positive Supply: +5V @ 90 mA
- 50 Ohm Matched Input/Output
- 12 Lead Ceramic 3x3mm SMT Package: 9mm²

Functional Diagram

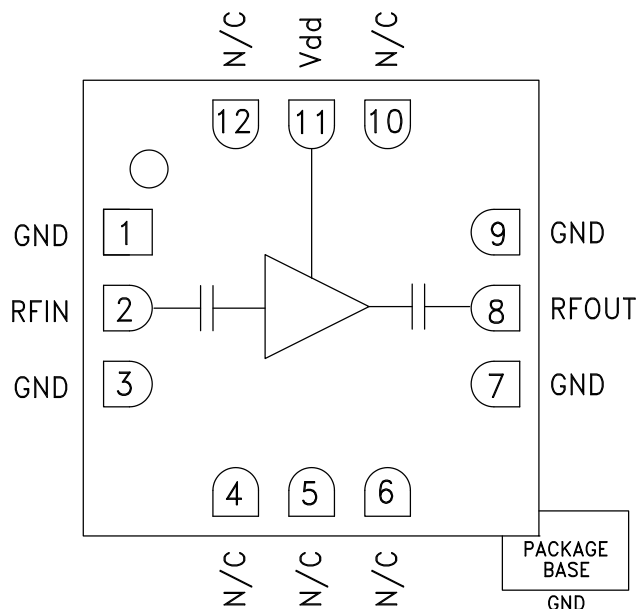

General Description

The HMC441LC3B is an efficient GaAs PHEMT MMIC Medium Power Amplifier housed in a leadless RoHS compliant SMT package. Operating between 6 and 18 GHz, the amplifier provides 14 dB of gain, +21.5 dBm of saturated power and 27% PAE from a +5V supply. This 50 Ohm matched amplifier does not require any external components and operates from a single positive supply, making it an ideal linear gain block or driver for HMC SMT mixers. The HMC441LC3B is compatible with high volume surface mount manufacturing techniques, and the I/Os are DC blocked for further ease of integration.

Electrical Specifications, $T_A = +25^\circ\text{C}$, $V_{dd} = +5\text{V}$

Parameter	Min.	Typ.	Max.	Min.	Typ.	Max.	Min.	Typ.	Max.	Min.	Typ.	Max.	Units
Frequency Range	6.0 - 8.5			8.5 - 12.5			12.5 - 14.0			14.0 - 18.0			GHz
Gain	10	14	19	13	17	21	13	17	21	10	14	19	dB
Gain Variation Over Temperature		0.015	0.02		0.015	0.02		0.015	0.02		0.015	0.02	dB/°C
Input Return Loss		10			13			20			13		dB
Output Return Loss		12			15			17			14		dB
Output Power for 1 dB Compression (P1dB)	16	19		17	20		17	20		17	20		dBm
Saturated Output Power (Psat)		20			21.5			22.5			21.5		dBm
Output Third Order Intercept (IP3)	28	30		29	32		29	32		29	32		dBm
Noise Figure		4.5	6		4.5	6		4.5	6		4.5	6	dB
Supply Current (I _{dd})		90	115		90	115		90	115		90	115	mA

**GaAs pHEMT MMIC MEDIUM
POWER AMPLIFIER, 6 - 18 GHz**

Broadband Gain & Return Loss

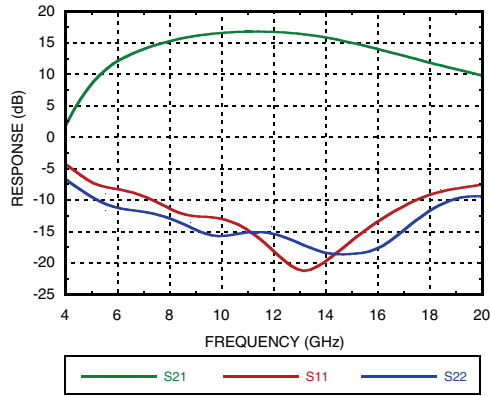

Gain vs. Temperature

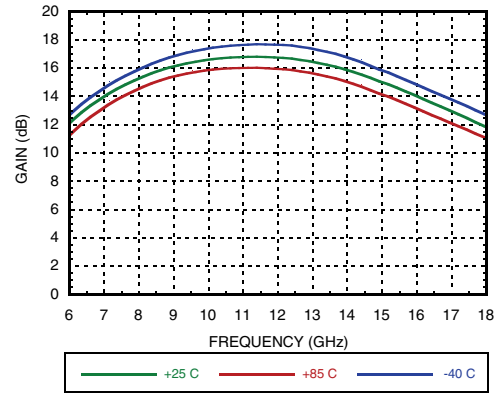

Input Return Loss vs. Temperature

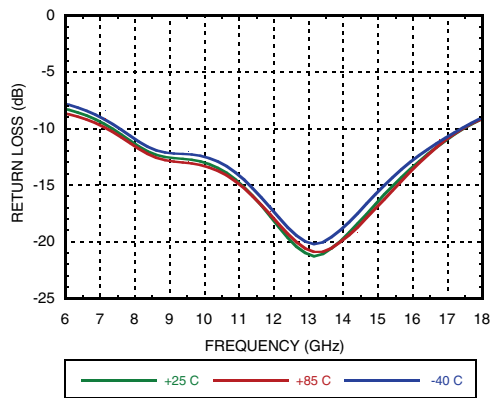

Output Return Loss vs. Temperature

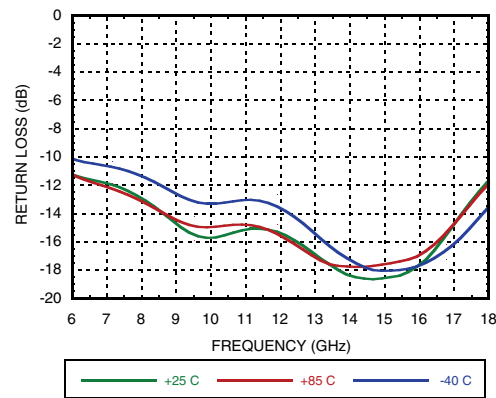

P1dB vs. Temperature

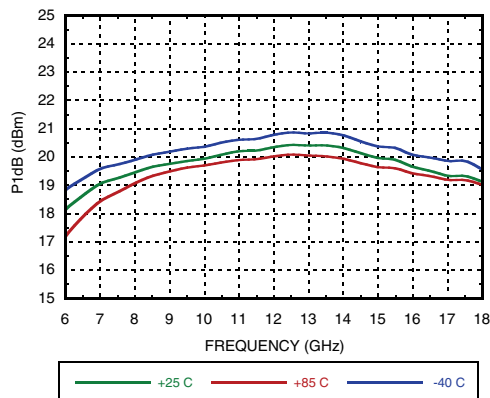

Psat vs. Temperature

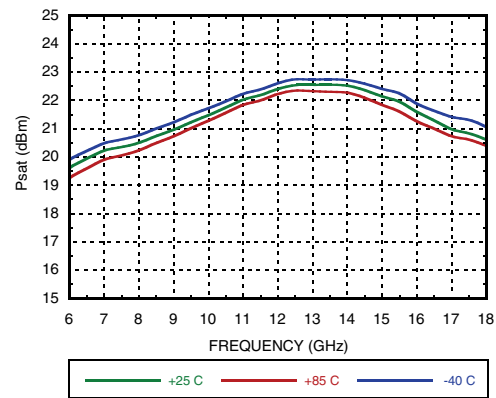

GaAs pHEMT MMIC MEDIUM POWER AMPLIFIER, 6 - 18 GHz

Power Compression @ 11 GHz

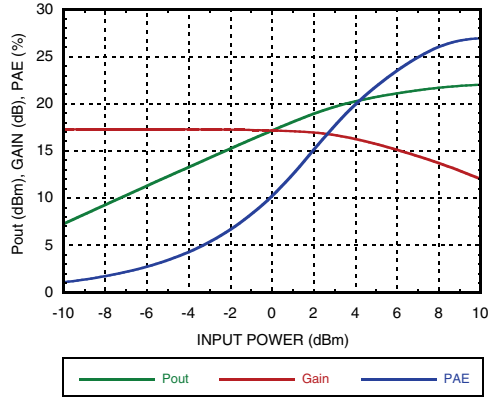

Power Compression @ 15 GHz

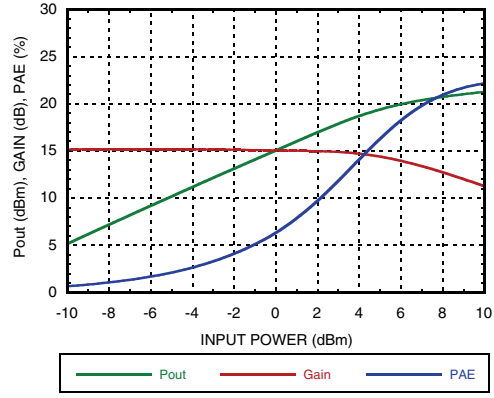

Output IP3 vs. Temperature

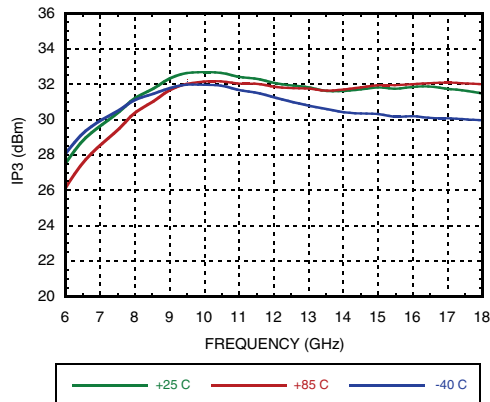

Noise Figure vs. Temperature

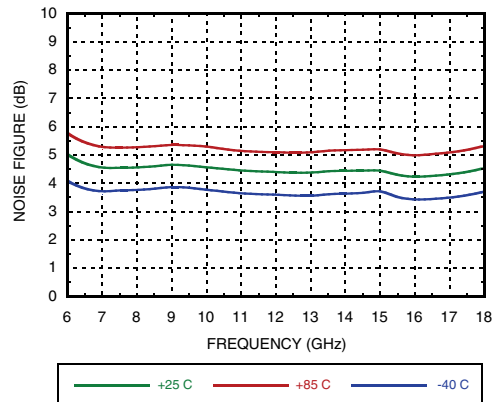

Gain, Power & Output IP3 vs. Supply Voltage @ 11 GHz

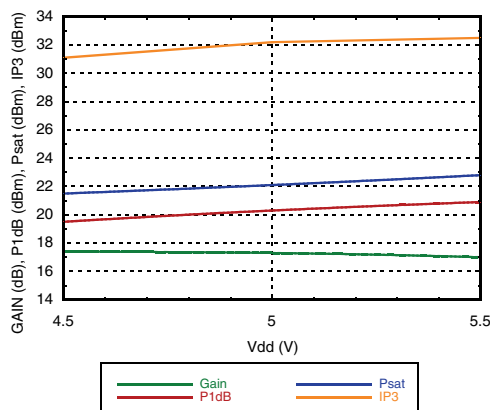

Reverse Isolation vs. Temperature

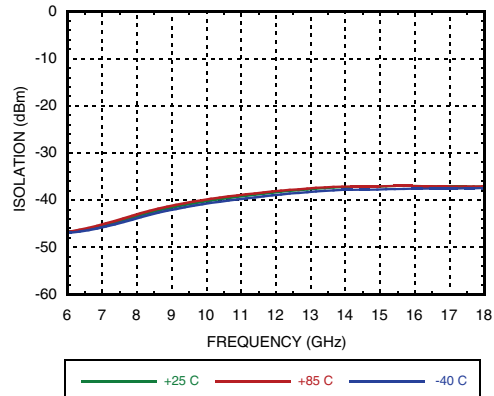

**GaAs pHEMT MMIC MEDIUM
POWER AMPLIFIER, 6 - 18 GHz**

**Additive Phase Noise Vs Offset Frequency,
RF Frequency = 8 GHz,
RF Input Power = 5 dBm (P1dB)**

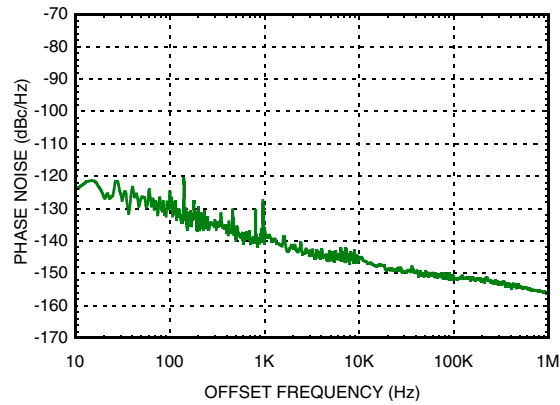

Notes:

GaAs pHEMT MMIC MEDIUM POWER AMPLIFIER, 6 - 18 GHz

Absolute Maximum Ratings

Drain Bias Voltage (Vdd)	+6 Vdc
RF Input Power (RFIN)(Vdd = +5 Vdc)	+15 dBm
Channel Temperature	175 °C
Continuous P _{diss} (T = 85 °C) (derate 8.2 mW/°C above 85 °C)	0.74 W
Thermal Resistance (channel to ground paddle)	122 °C/W
Storage Temperature	-65 to +150 °C
Operating Temperature	-40 to +85 °C
ESD Sensitivity (HBM)	Class 0, Passed 100V

Typical Supply Current vs. Vdd

Vdd (V)	I _{dd} (mA)
+5.5	92
+5.0	90
+4.5	88

Note: Amplifier will operate over full voltage range shown above



**ELECTROSTATIC SENSITIVE DEVICE
OBSERVE HANDLING PRECAUTIONS**

Outline Drawing

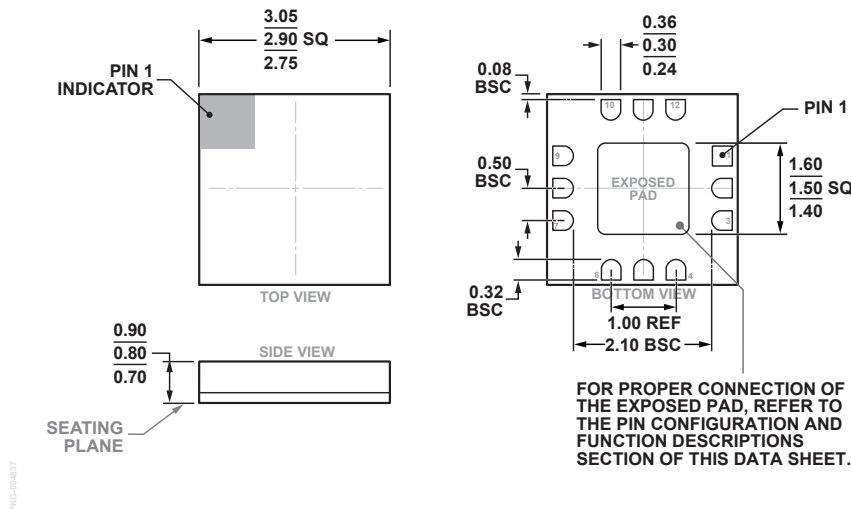

12-Terminal Ceramic Leadless Chip Carrier [LCC]
(E-12-4)
Dimensions shown in millimeters

Package Information

Part Number	Package Body Material	Lead Finish	MSL Rating	Package Marking ^[2]
HMC441LC3B	Alumina, White	Gold over Nickel	MSL3 ^[1]	H441 XXXX

[1] Max peak reflow temperature of 260 °C

[2] 4-Digit lot number XXXX

GaAs pHEMT MMIC MEDIUM POWER AMPLIFIER, 6 - 18 GHz

Pin Descriptions

Pin Number	Function	Description	Interface Schematic
1, 3, 7, 9	GND	Package bottom must also be connected to RF/DC ground	
2	RFIN	This pin is AC coupled and matched to 50 Ohms.	
4 - 6 10, 12	N/C	This pin may be connected to RF/DC ground. Performance will not be affected.	
8	RFOUT	This pin is AC coupled and matched to 50 Ohms.	
11	Vdd	Power Supply Voltage for the amplifier. External bypass capacitors are required.	

Application Circuit

Component	Value
C1	100 pF
C2	1,000 pF
C3	2.2 μF

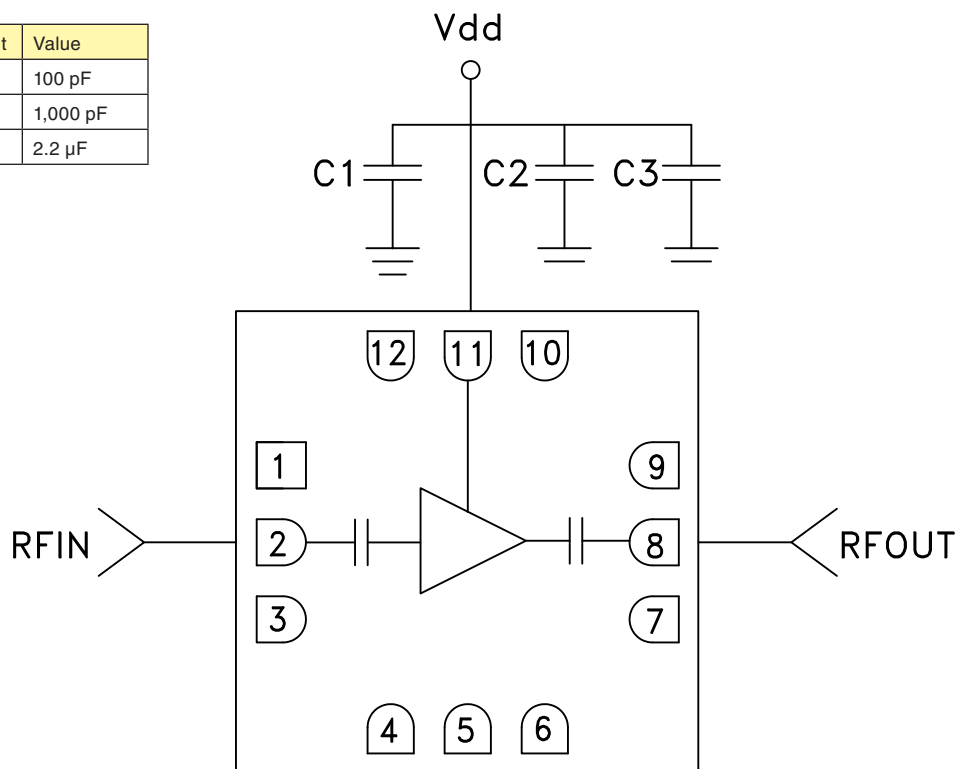

GaAs pHEMT MMIC MEDIUM POWER AMPLIFIER, 6 - 18 GHz

Evaluation PCB

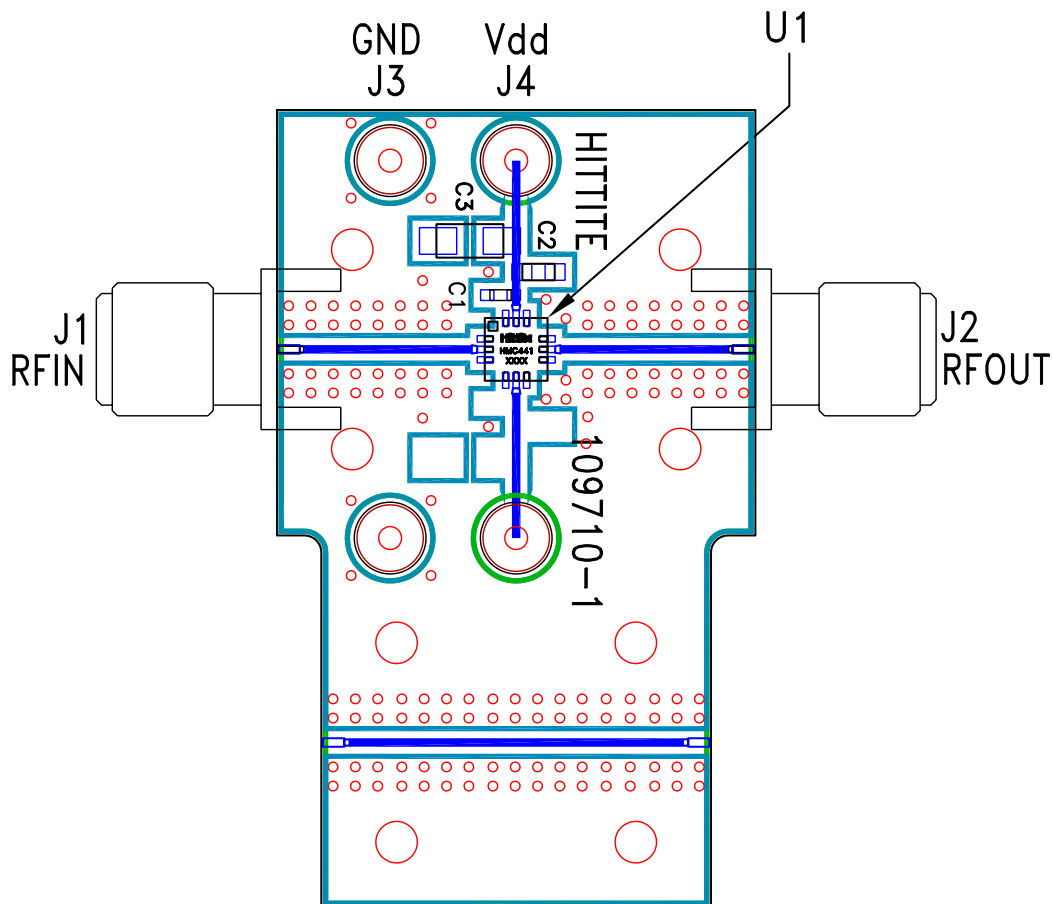

List of Materials for Evaluation PCB 109712 ^[1]

Item	Description
J1 - J2	PCB Mount SMA Connector
J3 - J4	DC Pin
C1	100 pF Capacitor, 0402 Pkg.
C2	1000 pF Capacitor, 0603 Pkg.
C3	2.2 μ F Capacitor, Tantalum
U1	HMC441LC3B Amplifier
PCB ^[2]	109710 Evaluation PCB, 10 mils

[1] Reference this number when ordering complete evaluation PCB

[2] Circuit Board Material: Rogers 4350

The circuit board used in the final application should use RF circuit design techniques. Signal lines should have 50 Ohm impedance while the package ground leads and exposed paddle should be connected directly to the ground plane similar to that shown. A sufficient number of via holes should be used to connect the top and bottom ground planes. The evaluation board should be mounted to an appropriate heat sink. The evaluation circuit board shown is available from Analog Devices upon request.