

ezyLED 24V DC 3030 EMC AB-EZD Series

ezyLED reduces driving circuit dramatically. All ezyLEDs are connected in parallel, and directly driven by a conventional 24V DC voltage source without the needs of the driver IC and passive components. With ezyLED so easy to use, users only have to focus on the design of the lamps. Inventory management of components is minimized.



AB-EZD products operate over a wide voltage range (Figure 3). Luminous intensity remains constant for $22.5V < V_{in} < 36V$, and maintains approximately 50% of its nominal value when input voltage drops to 21.5 volts.

AB-EZD products support over temperature protection (OTP) by reducing input current and hence the luminous intensity when the device temperature exceeds $120^{\circ}C$ (Figure 2). For long-term reliability, sufficient heat dissipation mechanism in lamp design is required to ensure ezyLED operates in the rated temperature range ($-40^{\circ}C \sim 85^{\circ}C$).



Features

- Patented LED chip design with built-in driving IC
- Using conventional 24V DC voltage sources
- All ezyLEDs connected in parallel
- Luminance and Correlated color temperature (CCT) remain constant while the input voltage varies over an extensive range
- Over temperature protection

Application

- Architectural lighting
- General lighting
- Down light
- Landscape lighting



General Characteristics (Ta=25°C @ Vin =12V)

Parameters	Symbol	Min.	Typ.	Max.	Unit
Luminous Flux@20mA (0.3W)	Φ_v		25		lm
Luminous Flux@50mA (0.5W)	Φ_v		50		lm
Luminous Flux@100mA (1.0W)	Φ_v		100		lm
Luminous Flux@110mA (Red)	Φ_v	39	42	44	lm
Luminous Flux@110mA (Green)	Φ_v	71	75	79	lm
Luminous Flux@110mA (Blue)	Φ_v	25	26	27	lm
Viewing Angle (FWHM)	$2\theta_{1/2}$		120		degree
Thermal Resistance (Junction to slug)	R_{th}		15		°C/W

Absolute Maximum Ratings

Parameters	Symbol	Min.	Typ.	Max.	Unit
Rated Voltage	Vin	22.5	24	36	Vdc
LED Junction Temperature	T _J			120	°C
Operation Temperature Range	T _c	-40		85	°C
ESD@HBM	ESDHBM			4K	V
Allowable Reflow cycles	-			3	cycles
Storage Temperature Range	-	-40		100	°C

Notes :

Parts are tested in pulsed conditions, Ta=25°C.

Pulse width is 10ms at rated voltage.

Tolerance of Luminous Intensity: ±10%

Maximum Temperature at solder pads (Tc) during operation: 85°C

The lifetime will be decreased if the operation temperature exceeds the maximum value.

Color	CCT/Wavelength		CRI	Power	Light Output		Part Number
	min	Max			T _a =25°C	T _c =85°C	
Red	620nm	630nm	N/A	0.3	9 lm	7 lm	AB-EZD03R-B3
Green	520nm	530nm	N/A	0.3	15 lm	12 lm	AB-EZD03G-B3
Blue	445nm	465nm	N/A	0.3	6 lm	5 lm	AB-EZD03B-B3
Cool White	7500K	8500K	70	0.5	55 lm	45 lm	AB-EZD05C-B3-K80
Cool White	6000K	7000K	70	0.5	55 lm	45 lm	AB-EZD05C-B3-K65
Cool White	5400K	6000K	70	0.5	55 lm	45 lm	AB-EZD05C-B3-K57
Neutral White	3725K	4275K	70	0.5	55 lm	45 lm	AB-EZD05N-B3-K40
Warm White	2850K	3150K	80	0.5	55 lm	45 lm	AB-EZD05W-B3-K30
Warm White	2650K	2850K	80	0.5	55 lm	45 lm	AB-EZD05W-B3-K27
Amber	1800K		N/A	0.5	35 lm	25 lm	AB-EZD05A-B3-K18
Amber	1300K		N/A	0.5	35 lm	25 lm	AB-EZD05A-B3-K13
Red	620nm	630nm	N/A	0.6	20 lm	16 lm	AB-EZD06R-B3
Green	520nm	530nm	N/A	0.6	30 lm	24 lm	AB-EZD06G-B3
Blue	445nm	465nm	N/A	0.6	12 lm	11 lm	AB-EZD06B-B3
Cool White	7500K	8500K	70	1	110 lm	90 lm	AB-EZD10C-B3-K80
Cool White	6000K	7000K	70	1	110 lm	90 lm	AB-EZD10C-B3-K65
Cool White	5400K	6000K	70	1	110 lm	90 lm	AB-EZD10C-B3-K57
Neutral White	3725K	4275K	70	1	110 lm	90 lm	AB-EZD10N-B3-K40
Warm White	2850K	3150K	80	1	110 lm	90 lm	AB-EZD10W-B3-K30
Warm White	2650K	2850K	80	1	110 lm	90 lm	AB-EZD10W-B3-K27
Amber	1800K		N/A	1	65 lm	50 lm	AB-EZD10A-B3-K18
Amber	1300K		N/A	1	65 lm	50 lm	AB-EZD10A-B3-K13
Red	620nm	630nm	N/A	1.3	39 lm	32 lm	AB-EZD13R-B3
Green	520nm	530nm	N/A	1.3	60 lm	49 lm	AB-EZD13G-B3
Blue	445nm	465nm	N/A	1.3	25 lm	22 lm	AB-EZD13B-B3
Cool White	7500K	8500K	70	2.4	210 lm	170 lm	AB-EZD24C-B3-K80
Cool White	6000K	7000K	70	2.4	210 lm	170 lm	AB-EZD24C-B3-K65
Cool White	5400K	6000K	70	2.4	210 lm	170 lm	AB-EZD24C-B3-K57
Neutral White	3725K	4275K	70	2.4	210 lm	170 lm	AB-EZD24N-B3-K40
Warm White	2850K	3150K	80	2.4	210 lm	170 lm	AB-EZD24W-B3-K30
Warm White	2650K	2850K	80	2.4	210 lm	170 lm	AB-EZD24W-B3-K27
Red	620nm	630nm	N/A	2.4	72 lm	60 lm	AB-EZD24R-B3
Green	520nm	530nm	N/A	2.4	120 lm	96 lm	AB-EZD24G-B3
Blue	445nm	465nm	N/A	2.4	46 lm	41 lm	AB-EZD24B-B3

Notes: Maintains a tolerance of +/-10% on flux measurements and +/-2 on CRI measurements.
Parts are tested in pulsed conditions, T_a=25°C. Pulse width is 10ms at rated test voltage.

Figure 1. Relative Spectral Power Distribution ($V_f=24Vdc$)

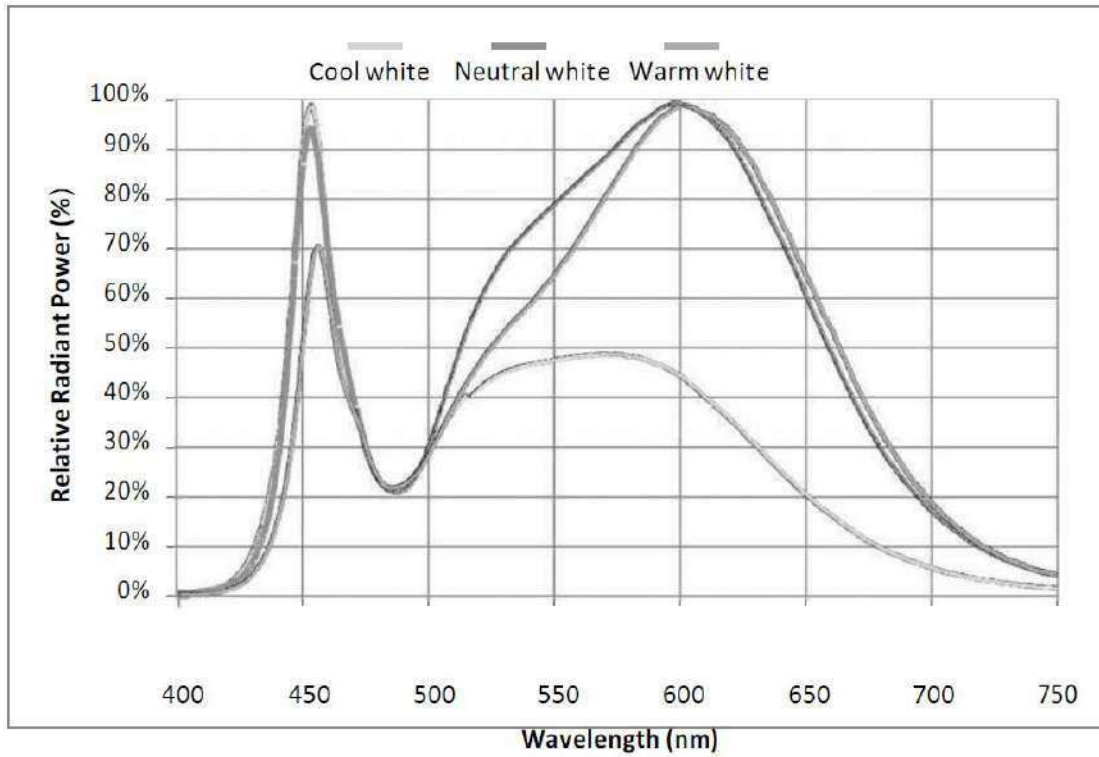

Figure 2 Relative Luminous Flux vs. Temperature (T_c)

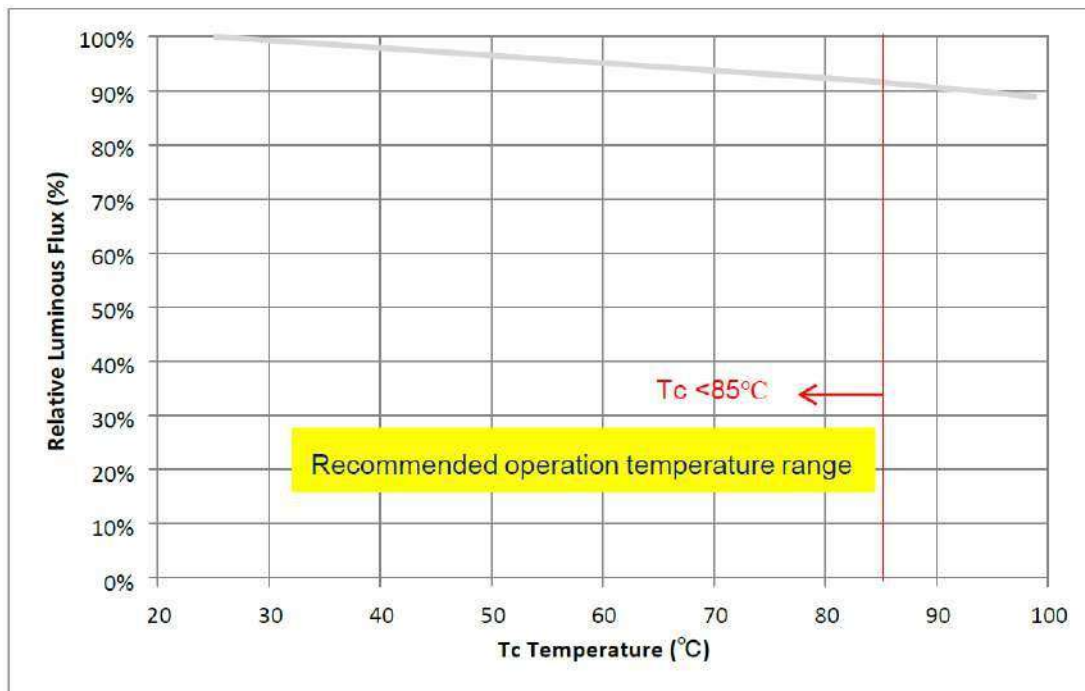

Figure 3 Relative Luminous Flux vs. Operation Voltage (Tc<85°C)

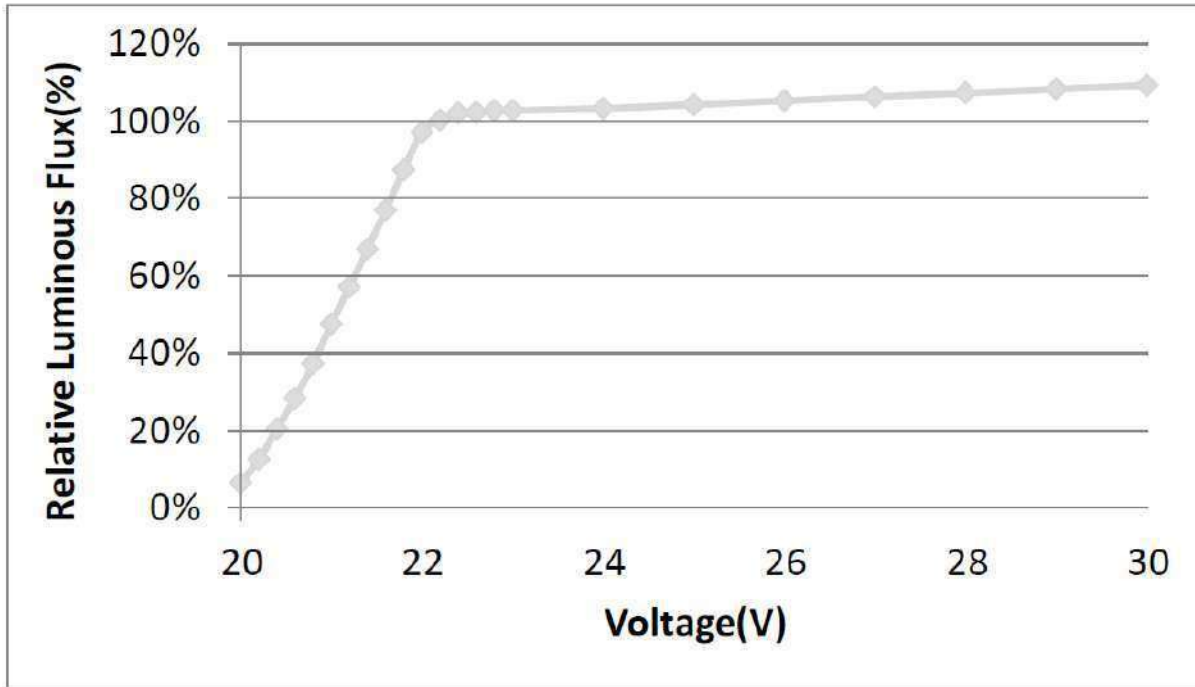

Figure 4 Radiation Diagram

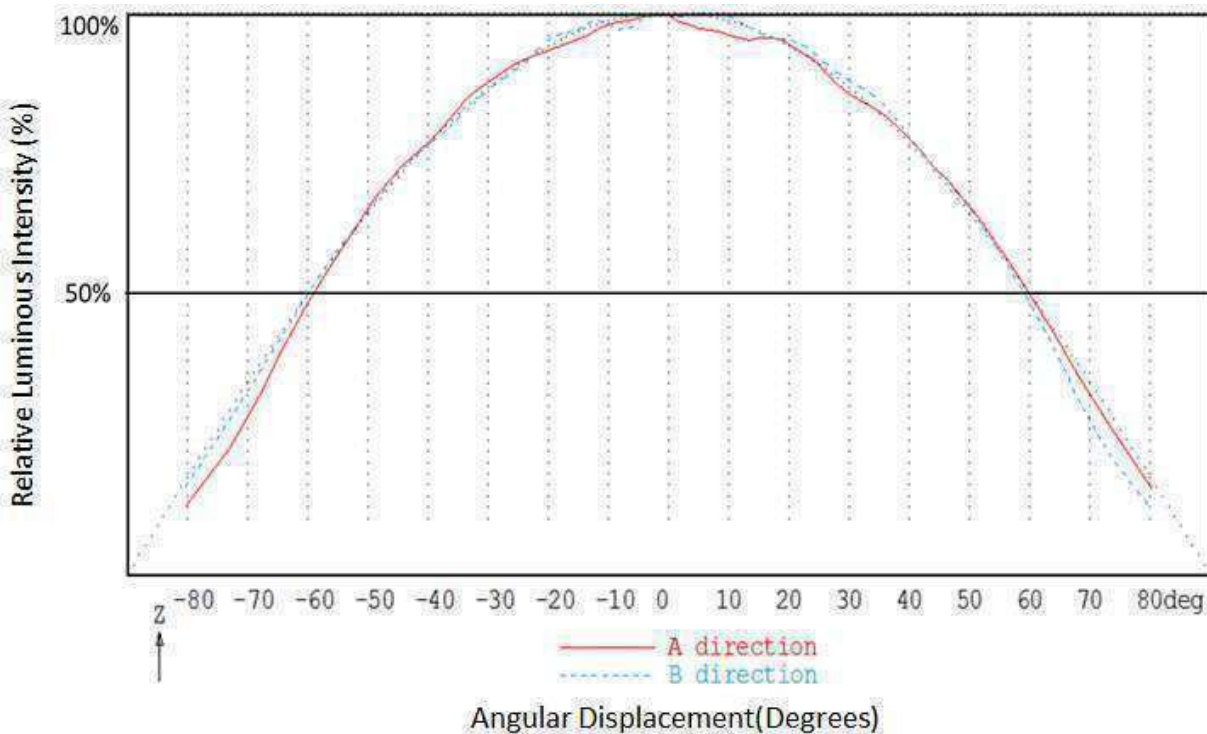

Figure 5 ezyLED ANSI White Bins Plotted on the 1931 CIE Color Space ($T_j=85^\circ\text{C}$)

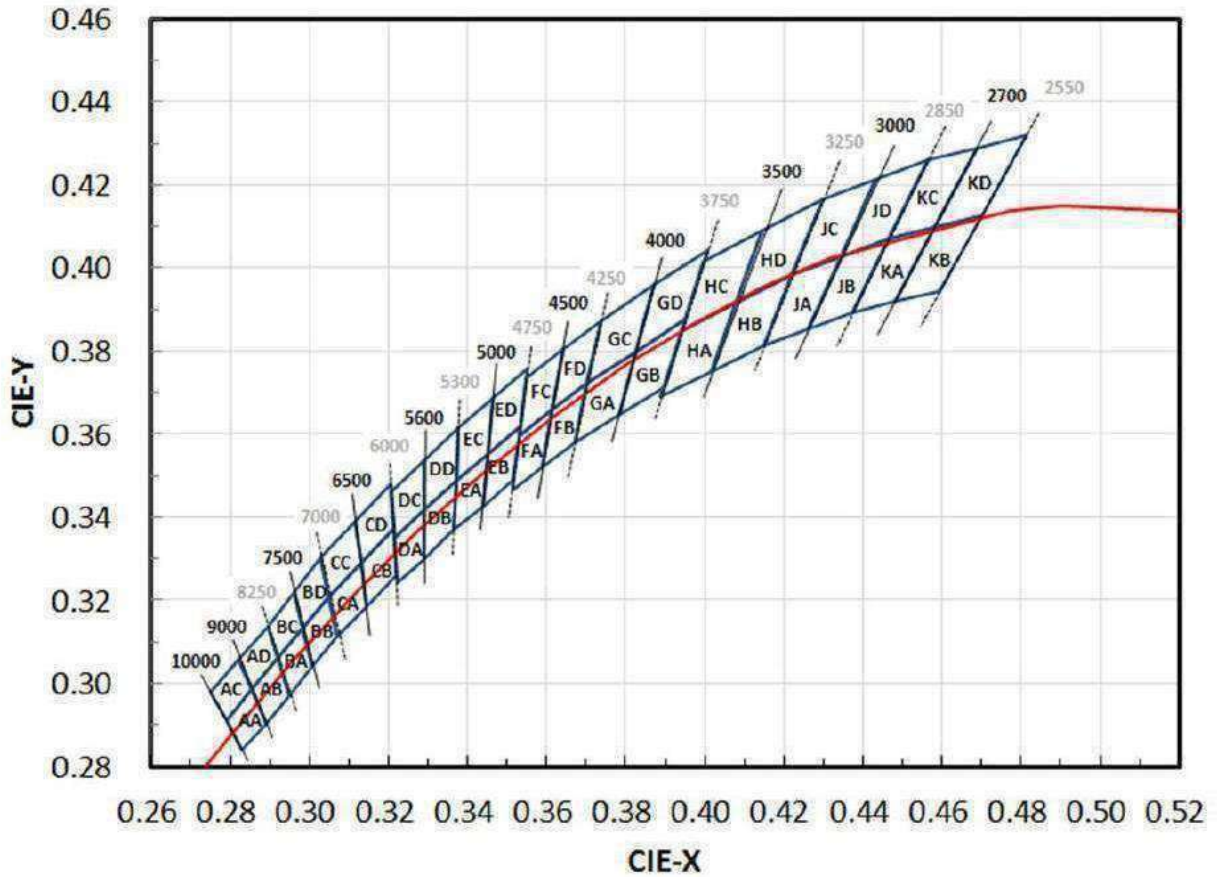
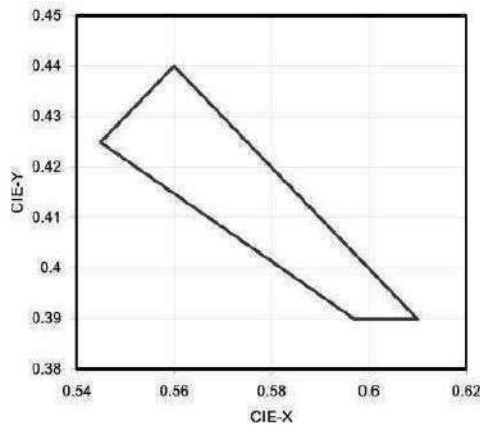

Figure 6 ezyLED PC-amber Plotted on the 1931 CIE Color Space ($T_j=85^\circ\text{C}$)



ezyLED are tested for chromaticity and placed into one of the regions defined by the following bounding coordinates

- White light product:

AA	0.2830	0.2840	BA	0.2950	0.2970	CA	0.3068	0.3113	DA	0.3222	0.3243	EA	0.3366	0.3369
	0.2790	0.2910		0.2920	0.3060		0.3048	0.3207		0.3215	0.3350		0.3371	0.3490
	0.2855	0.2985		0.2984	0.3133		0.3130	0.3290		0.3290	0.3417		0.3451	0.3554
	0.2890	0.2905		0.3009	0.3042		0.3144	0.3186		0.3290	0.3300		0.3440	0.3427
AB	0.2830	0.2840	BB	0.2950	0.2970	CB	0.3068	0.3113	DB	0.3222	0.3243	EB	0.3366	0.3369
	0.2890	0.2905		0.3009	0.3042		0.3144	0.3186		0.3290	0.3300		0.3440	0.3427
	0.2855	0.2985		0.2984	0.3133		0.3130	0.3290		0.3290	0.3417		0.3451	0.3554
	0.2920	0.3060		0.3048	0.3207		0.3213	0.3373		0.3371	0.3490		0.3533	0.3620
AC	0.2790	0.2910	BC	0.2920	0.3060	CC	0.3048	0.3207	DC	0.3215	0.3350	EC	0.3371	0.3490
	0.2750	0.2980		0.2895	0.3135		0.3028	0.3304		0.3207	0.3462		0.3376	0.3616
	0.2823	0.3058		0.2962	0.3220		0.3115	0.3391		0.3290	0.3538		0.3463	0.3687
	0.2855	0.2985		0.2984	0.3133		0.3130	0.3290		0.3290	0.3417		0.3451	0.3554
AD	0.2790	0.2910	BD	0.2920	0.3060	CD	0.3048	0.3207	DD	0.3215	0.3350	ED	0.3371	0.3490
	0.2855	0.2985		0.2984	0.3133		0.3130	0.3290		0.3290	0.3417		0.3451	0.3554
	0.2823	0.3058		0.2962	0.3220		0.3115	0.3391		0.3290	0.3538		0.3463	0.3687
	0.2895	0.3135		0.3028	0.3304		0.3205	0.3481		0.3376	0.3616		0.3551	0.3760
FA	0.3512	0.3465	GA	0.3670	0.3578	HA	0.3889	0.3690	IA	0.4147	0.3814	KA	0.4373	0.3893
	0.3530	0.3597		0.3702	0.3722		0.3941	0.3848		0.4221	0.3984		0.4465	0.4071
	0.3615	0.3659		0.3825	0.3798		0.4080	0.3916		0.4342	0.4028		0.4582	0.4099
	0.3590	0.3521		0.3783	0.3646		0.4017	0.3751		0.4259	0.3853		0.4483	0.3919
FB	0.3512	0.3465	GB	0.3670	0.3578	HB	0.3889	0.3690	JB	0.4147	0.3814	KB	0.4373	0.3893
	0.3590	0.3521		0.3783	0.3646		0.4017	0.3751		0.4259	0.3853		0.4483	0.3919
	0.3615	0.3659		0.3825	0.3798		0.4080	0.3916		0.4342	0.4028		0.4582	0.4099
	0.3702	0.3722		0.3950	0.3875		0.4221	0.3984		0.4465	0.4071		0.4700	0.4125
FC	0.3670	0.3578	GC	0.3898	0.3716	HC	0.4147	0.3814	JC	0.4373	0.3893	KC	0.4593	0.3944
	0.3590	0.3521		0.3783	0.3646		0.4017	0.3751		0.4259	0.3853		0.4483	0.3919
	0.3530	0.3597		0.3702	0.3722		0.3941	0.3848		0.4221	0.3984		0.4465	0.4071
	0.3641	0.3804		0.3869	0.3958		0.4146	0.4089		0.4430	0.4212		0.4687	0.4289
FD	0.3615	0.3659	GD	0.3825	0.3798	HD	0.4080	0.3916	JD	0.4342	0.4028	KD	0.4582	0.4099
	0.3530	0.3597		0.3702	0.3722		0.3941	0.3848		0.4221	0.3984		0.4465	0.4071
	0.3641	0.3804		0.3869	0.3958		0.4146	0.4089		0.4430	0.4212		0.4687	0.4289
	0.3736	0.3874		0.4006	0.4044		0.4299	0.4165		0.4562	0.4260		0.4813	0.4319
FA	0.3702	0.3722	GA	0.3950	0.3875	HA	0.4221	0.3984	IA	0.4465	0.4071	KA	0.4700	0.4125
	0.3615	0.3659		0.3825	0.3798		0.4080	0.3916		0.4342	0.4028		0.4582	0.4099
	0.3590	0.3521		0.3783	0.3646		0.4017	0.3751		0.4259	0.3853		0.4483	0.3919
	0.3512	0.3465		0.3670	0.3578		0.3889	0.3690		0.4147	0.3814		0.4373	0.3893

- PC-amber product:

PC-amber	0.56	0.44
	0.54491	0.42491
	0.59701	0.39
	0.61	0.39

Figure 7 Mechanical Dimensions

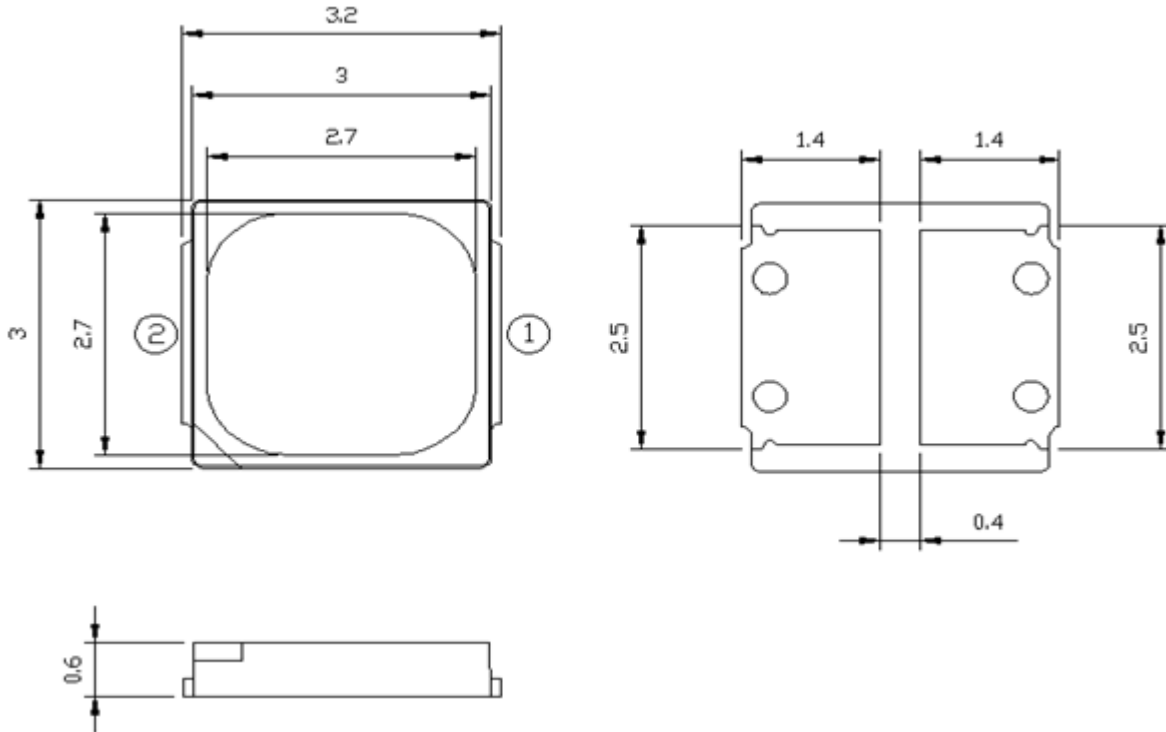

*The built-in IC determines the input polarity. There is no specific polarity assigned for PIN1 and PIN2.

Notes:

1. All dimensions are in mm.
2. Tolerance is +/- 0.02mm unless otherwise specified.
3. Drawings are not to scale.

Figure 8 Block diagram

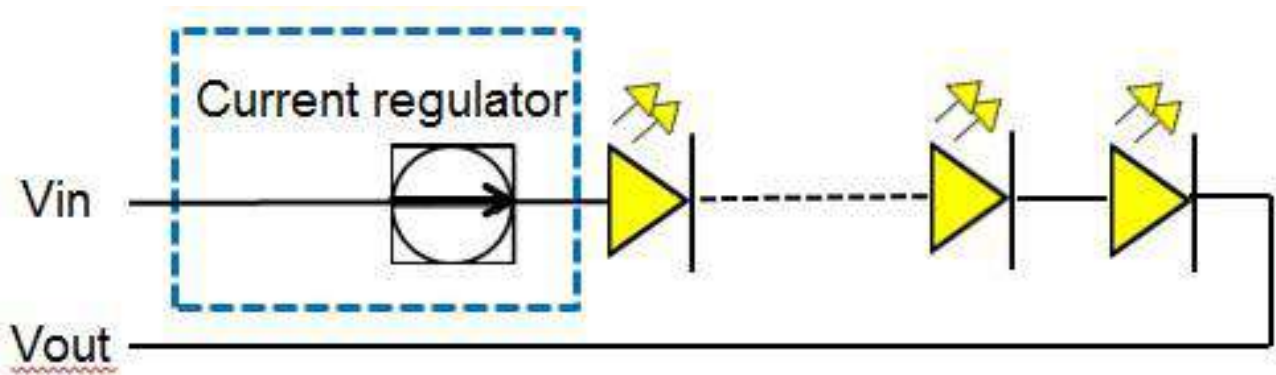
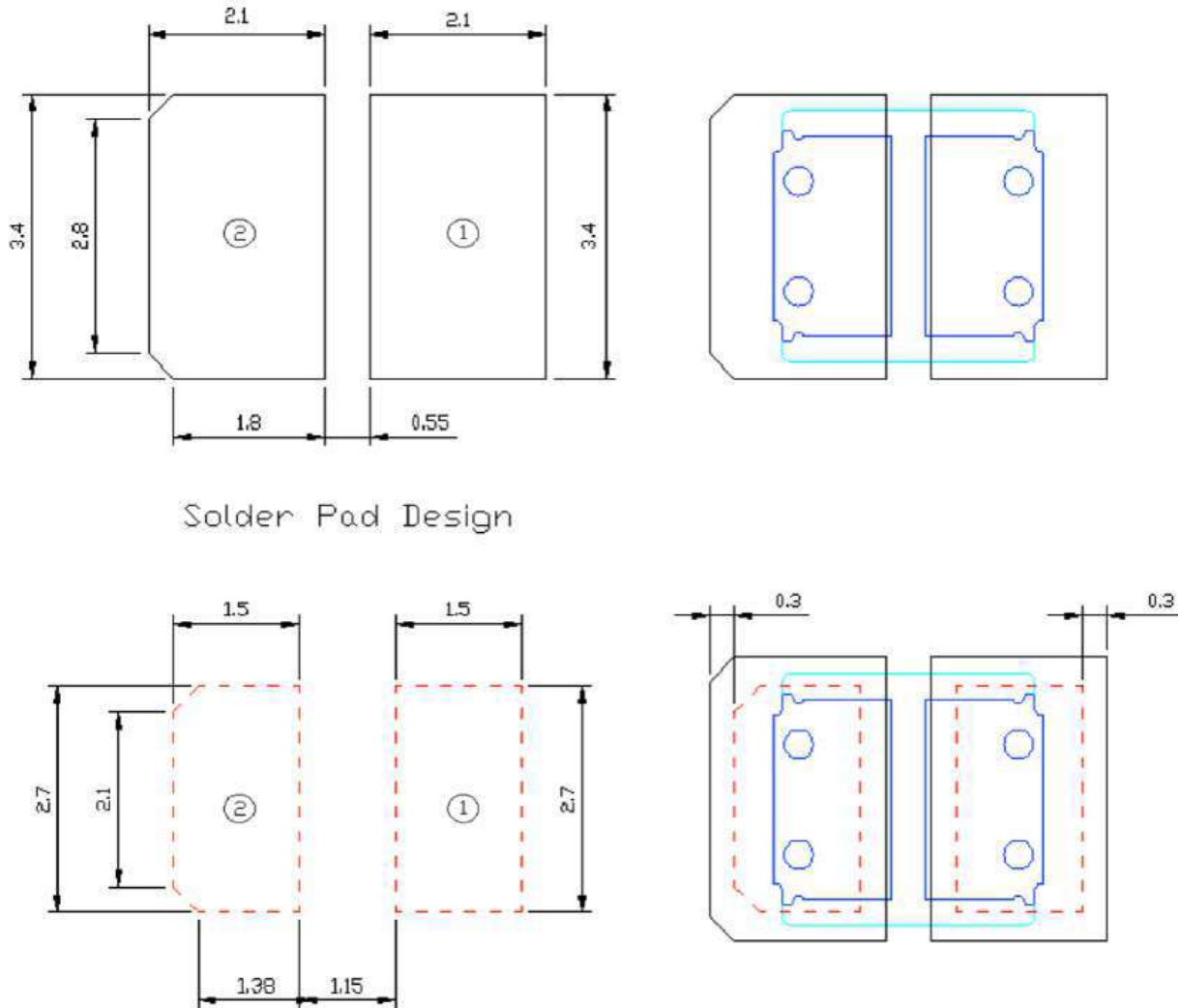

Figure 9 Recommended Solder Pad Dimensions



*The built-in IC determines the input polarity. There is no specific polarity assigned for PIN1 and PIN2.

Notes:

1. All dimensions are in mm.
2. Tolerance is +/- 0.02mm unless otherwise specified.
3. Drawings are not to scale.
4. Do not handle 3030 devices by the lens. Incorrect force applied to the lens may lead to the failure.

Figure 10 Application reference

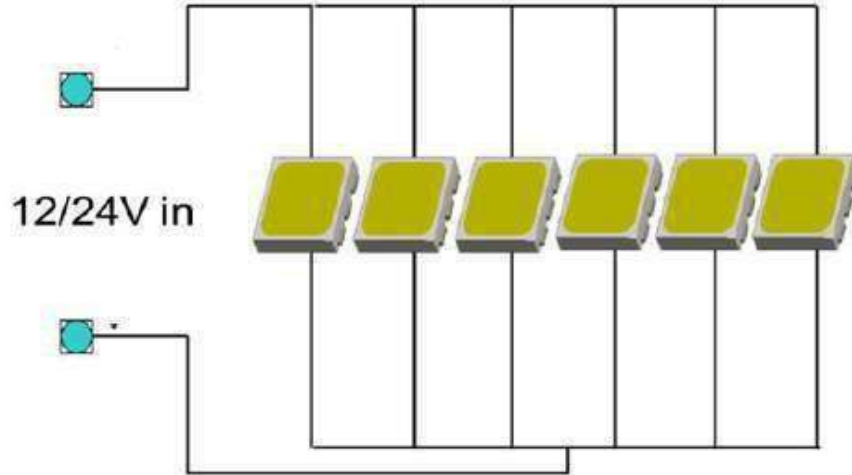

Figure 11 EMC Package

The figure includes a cross-section diagram of an LED package with the following labels: LED chip, Wire, White epoxy molding compound, Lead frame, Metal PCB, and Transparent compound. To the right, there are three images: 'Product appearance' showing three white cylindrical packages, 'After Transfer Molding' showing a tray of packaged LEDs, and 'A Lighting Blue LED' showing a single LED emitting a blue glow with a 5mm scale bar.

CEL-W-Series(7005D1 etc.)

- Long-lasting high reflection
- Good heat and UV resistance
- Applicable for transfer molding including MAP

Figure 12 Soldering Condition (Reference: IPC/JEDEC J-STD-020C)

ezyLED ZE1C series are compatible with IPC/JEDEC J-STD-020C, following the parameters listed below. Recommends that users follow the recommended soldering profile as the general guideline.

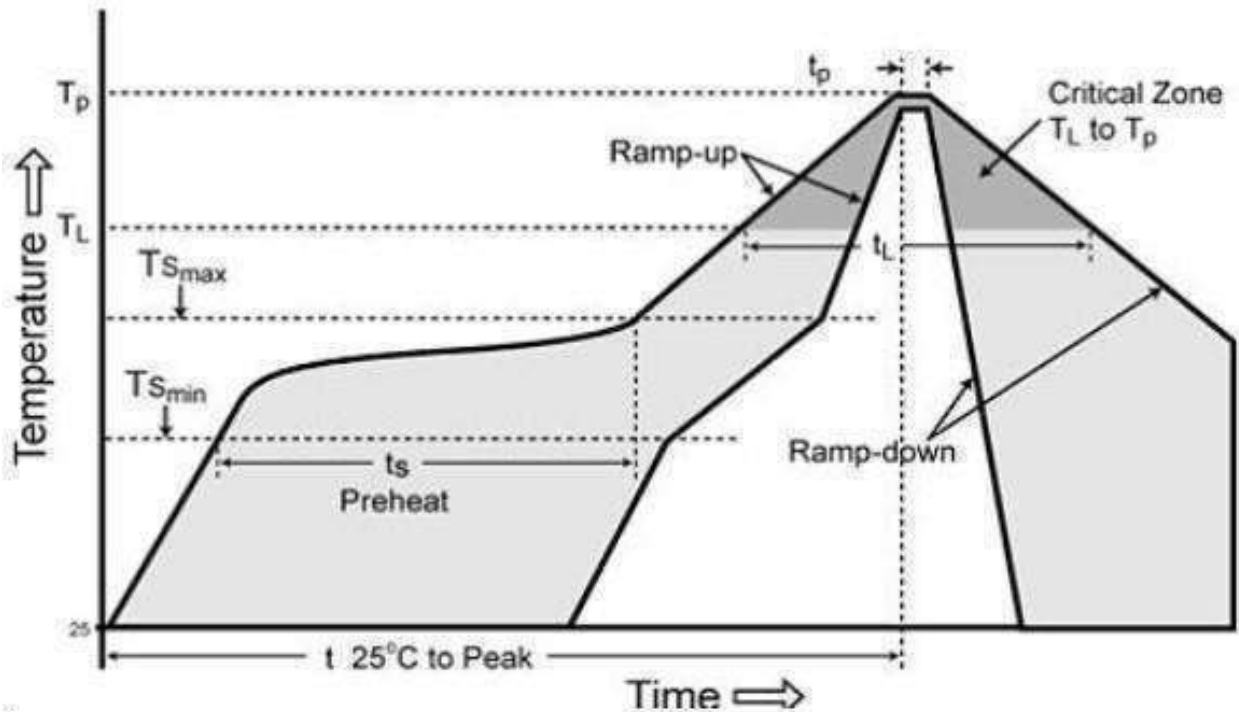

Profile Feature	Pb-Free Assembly
Average ramp-up rate (TL to TP)	3°C/second max.
Preheat	
Temperature Min (T _{smin})	150°C
Temperature Max (T _{smax})	200°C
Time (min to max) (t _s)	60-180 seconds
Time maintained above:	
Temperature (T _L)	217°C
Time (t _L)	60-150 seconds
Peak/Classification Temperature (T _p)	240°C
Time within 5°C of actual Peak Temperature (t _p)	20-40 seconds
Ramp-down Rate	6°C/second max.
Time 25°C to Peak Temperature	8 minutes max.

