

THT Current Sense Transformers

P0581NL / P0582NL AND P0583NL



- ⌚ UL/C-UL recognized components
- ⌚ 3000Vrms gate to drive winding test
- ⌚ Useful operating frequency from 50kHz to 500 kHz
- ⌚ Most popular winding configurations

Electrical Specifications @ 25°C - Operating Temperature -40°C to +130°C

Part ⁶ Number	Turns Ratio	Primary Inductance (1-10) (mH MIN)	DCR Pri (1-10) (Ω MAX)	DCR Sec1 (3-7) (mΩ ±15%)	DCR Sec2 (4-8) (mΩ ±15%)	Hipot (Pri-Sec) (Vrms)
P0581NL	200:1:1	76	2.8	1.7	1.7	3000
P0582NL	100:1:1	19	1.4	1.7	1.7	3000
P0583NL	50:1:1	5	0.7	1.7	1.7	3000

Additional Specifications

Part Number	Reference Data				Calculation Data	
	RT	Ipk (Amps)	Droop (%)	Max Flux Density	Kb	Req (mΩ)
P0581NL	200	34	1.00	2000	17.12	.9
P0582NL	100	35	1.98	2000	68.49	.8
P0583NL	15	36	1.19	2000	273.97	.75

Notes:

1. These current sense transformers have two one turn primaries that can be used in parallel. The listed current ratings are for parallel connection.
2. The reference values are for an application using the termination resistor (Rt) and operating with unipolar waveform at 100kHz, 40% duty cycle. The estimated temperature rise is 55°C.
3. The peak flux density should remain below 2100 Gauss to ensure that the core does not saturate. Use the following formula to calculate the peak flux density: $B_{pk} = K_b * I_{pk} * R_t * \text{don} / (F_f * \text{freq. in kHz})$ where: Rt is the terminating resistor in the application and the Ff is 1 for unipolar waveform and 2 for bipolar waveform.
4. To calculate the droop: Droop Exponent (D) = $R_t * \text{don} / (L_{pri} \text{ in mH} * \text{Freq. in kHz})$
 $\% \text{Droop} = (1 - e^{-D}) * 100$
5. The temperature rise of the component is calculated based on the total core loss and copper loss:
 - A. To calculate total copper loss (W): $P_{(cu)} = I_{pk}^2 * R_{eq} * F_f * \text{don}$ where Ff is 1 for unipolar waveform and 2 for bipolar waveform
 - B. To calculate total core loss (W): $P_{(core)} = 0.000073 * (\text{Freq. in kHz})^{1.67} * (B_{op} \text{ in kG})^{2.532}$ where: $B_{op} \text{ in kG} = K_b * I_{pk} * R_t * \text{don} / (2000 * \text{Freq. in kHz})$
 - C. To calculate temperature rise: $\text{Temperature Rise (C)} = 60.18 * (\text{Core Loss (W)} + \text{Copper Loss (W)})^{.433}$

THT Current Sense Transformers

P0581NL / P0582NL AND P0583NL



Mechanical

Schematic

P058XNL

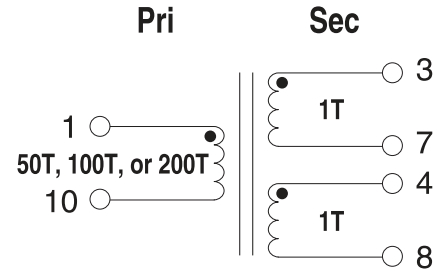
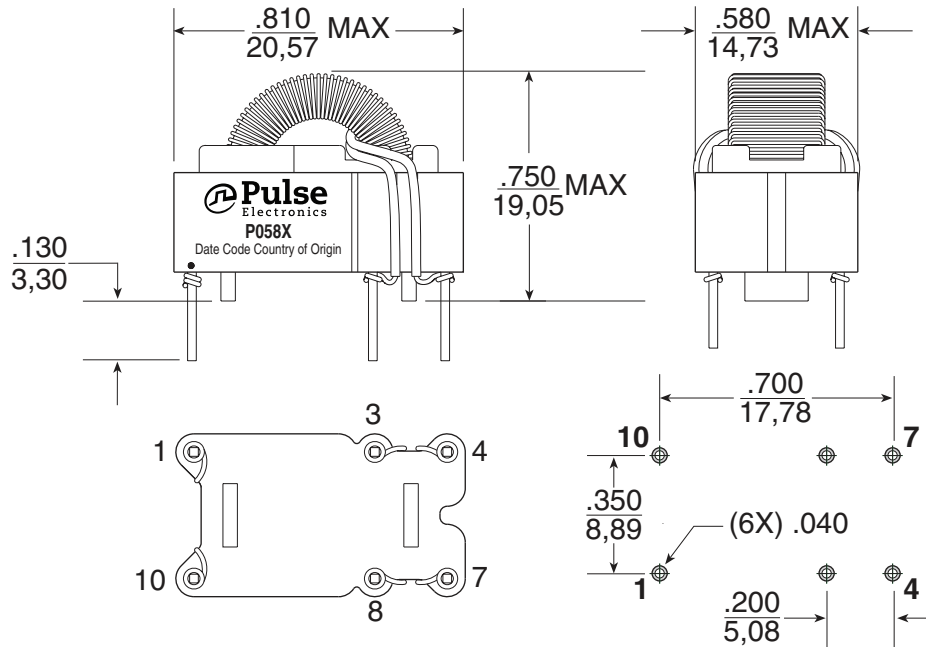

Weight5 grams
Tray80/tray

Dimensions: $\frac{\text{Inches}}{\text{mm}}$
Unless otherwise specified,
all tolerances are: $\pm \frac{010}{0,25}$

SUGGESTED PCB HOLE PATTERN

For More Information

Pulse Worldwide Headquarters

15255 Innovation Drive Ste 100
San Diego, CA 92128
U.S.A.

Pulse Europe

Pulse Electronics GmbH
Am Rottland 12
58540 Meinerzhagen
Germany

Pulse China Headquarters

Pulse Electronics (ShenZhen) CO., LTD
D708, Shenzhen Academy of
Aerospace Technology,
The 10th Keji South Road,
Nanshan District, Shenzhen,
P.R. China 518057

Pulse North China

Room 2704/2705
Super Ocean Finance Ctr.
2067 Yan An Road West
Shanghai 200336
China

Pulse South Asia

3 Fraser Street 0428
DUO Tower
Singapore 189352

Pulse North Asia

1F., No.111 Xiyuan Road
Zhongli District
Taoyuan City 32057
Taiwan (R.O.C)

Tel: 858 674 8100
Fax: 858 674 8262

Tel: 49 2354 777 100
Fax: 49 2354 777 168

Tel: 86 755 33966678
Fax: 86 755 33966700

Tel: 86 21 62787060
Fax: 86 21 62786973

Tel: 65 6287 8998
Fax: 65 6280 0080

Tel: 886 3 4356768
Fax: 886 3 4356820

Performance warranty of products offered on this data sheet is limited to the parameters specified. Data is subject to change without notice. Other brand and product names mentioned herein may be trademarks or registered trademarks of their respective owners. © Copyright, 2019. Pulse Electronics, Inc. All rights reserved.