

Molding Type Power Inductor

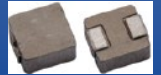

ASPI-0630LR

Request Samples



Check Inventory



7.1 x 6.60 x 2.8 mm
RoHS/RoHS II Compliant
MSL Level = 1

Features

- High saturation current
- Low loss due to low DC resistance
- Frequency application up to 3MHz
- Low profile with max thickness 3.0mm

Applications

- DC/DC converters in Notebook, desktops, and servers
- Low profile, high current power supplies

Electrical Specifications

Part Number	Inductance	Tolerance	DCR Max	Saturation Current Typ.	Temperature Rise Current Typ.
Units	μH	%	m Ω	A	A
Symbol	L	M		Isat	Irms
ASPI-0630LR-R22	0.22	M	3.0	34.0	24.0
ASPI-0630LR-R33	0.33	M	3.5	23.0	21.0
ASPI-0630LR-R47	0.47	M	4.1	20.0	18.0
ASPI-0630LR-R56	0.56	M	5.0	18.0	16.0
ASPI-0630LR-R68	0.68	M	6.5	17.0	16.0
ASPI-0630LR-R82	0.82	M	7.5	16.0	14.0
ASPI-0630LR-1R0	1.0	M	9.0	15.0	12.0
ASPI-0630LR-1R5	1.5	M	12.1	12.0	10.0
ASPI-0630LR-2R2	2.2	M	18.5	10.0	8.0
ASPI-0630LR-3R3	3.3	M	28.0	9.5	6.5
ASPI-0630LR-4R7	4.7	M	35.0	6.5	5.5
ASPI-0630LR-5R6	5.6	M	42.0	5.0	5.0
ASPI-0630LR-6R8	6.8	M	60.0	6.0	4.5
ASPI-0630LR-8R2	8.2	M	60.0	5.5	5.0
ASPI-0630LR-100	10.0	M	68.0	5.5	4.0
ASPI-0630LR-150	15.0	M	120.0	4.0	3.0
ASPI-0630LR-220	22.0	M	170.0	2.5	2.5
ASPI-0630LR-330	33.0	M	270.0	2.5	2.0
ASPI-0630LR-470	47.0	M	385.0	2.0	1.5

Test Conditions

Inductance is measured using Wayne Kerr3260+3265B at 100KHz, 1V.

RDC is measured using HIOKI3540.

Isat: Based on inductance change ($\Delta L/L_0 : \leq -30\%$)

Irms: Based on temperature rise ($\Delta T : 40^\circ\text{C TYP.}$)

Operating Temperature: -55°C to $+125^\circ\text{C}$ (Including self-generated heat)

Storage Temperature and Humidity: $< 35^\circ\text{C}$, 35% to 65% RH



5101 Hidden Creek Ln Spicewood TX 78669
Phone: 512-371-6159 | Fax: 512-351-8858
For terms and conditions of sales, please visit:
www.abracon.com

REVISION: C 11-08-22

ABRACON IS
ISO9001-2015
CERTIFIED

Molding Type Power Inductor



ASPI-0630LR

Request Samples



Check Inventory



7.1 x 6.60 x 2.8 mm
RoHS/RoHS II Compliant
MSL Level = 1

Electrical Characteristic Curves

ASPI-0630LR-1R0

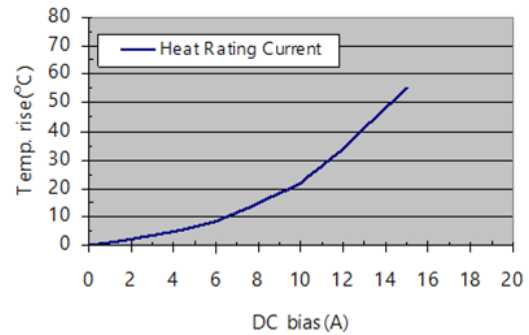
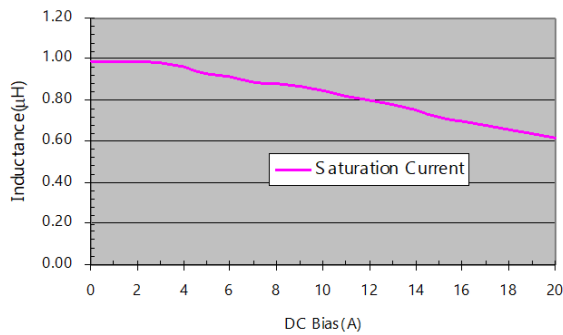

ASPI-0630LR-1R5

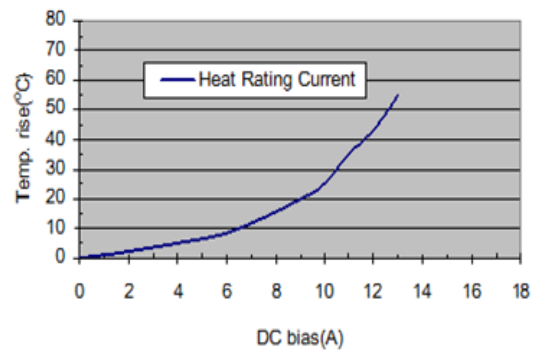
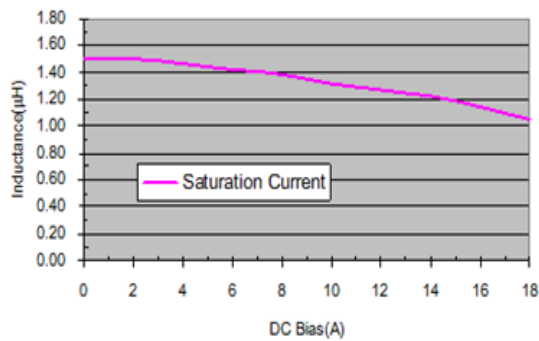

ASPI-0630LR-2R2

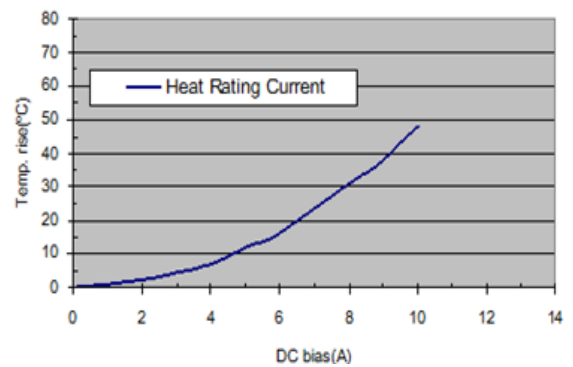
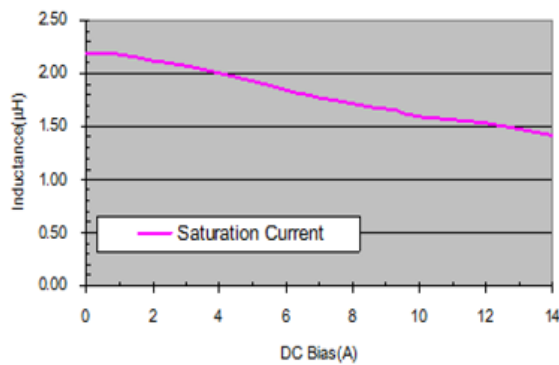

Molding Type Power Inductor



ASPI-0630LR

Request Samples



Check Inventory



7.1 x 6.60 x 2.8 mm
RoHS/RoHS II Compliant
 MSL Level = 1

ASPI-0630LR-3R3

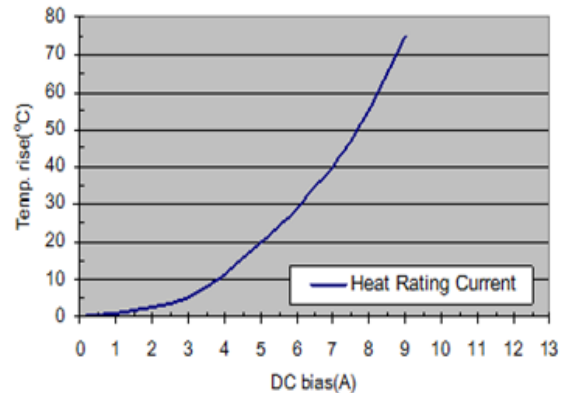
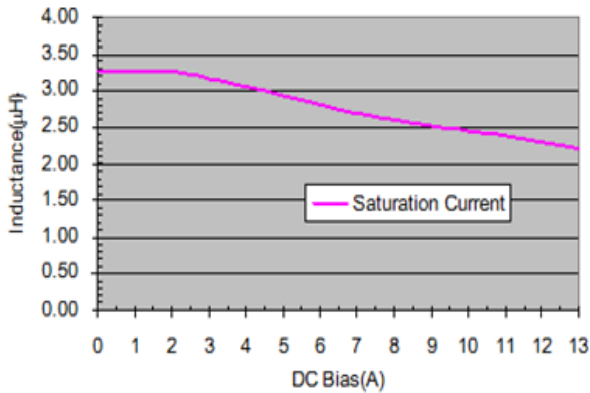

ASPI-0630LR-4R7

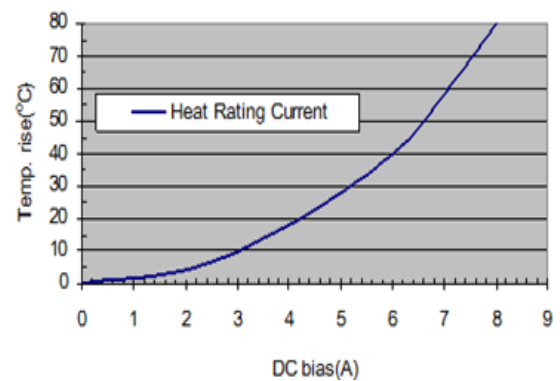
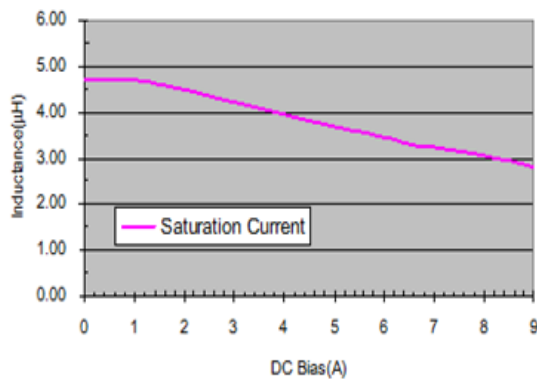

ASPI-0630LR-5R6

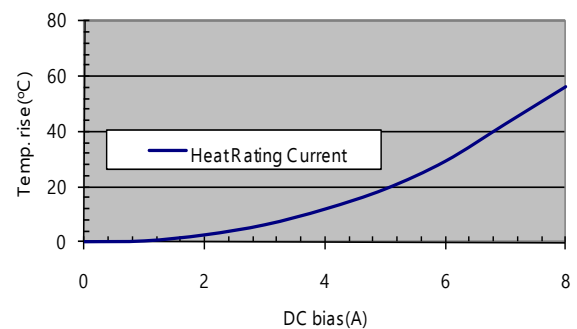
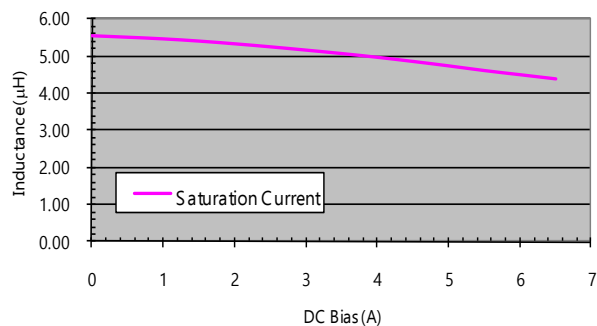

Molding Type Power Inductor



ASPI-0630LR

Request Samples



Check Inventory



7.1 x 6.60 x 2.8 mm
RoHS/RoHS II Compliant
 MSL Level = 1

ASPI-0630LR-6R8

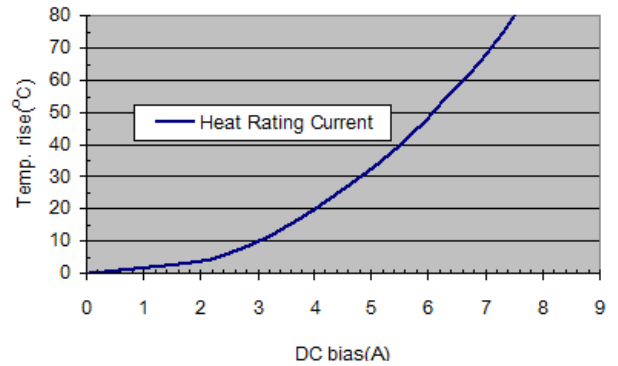
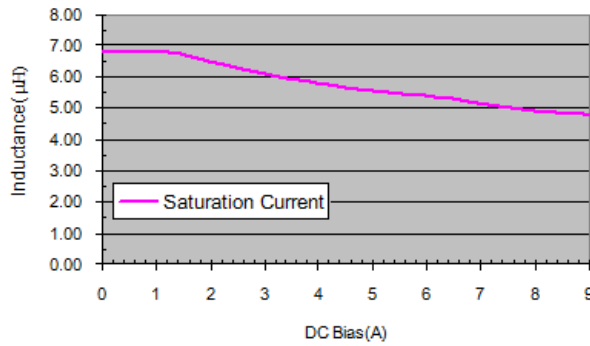

ASPI-0630LR-100

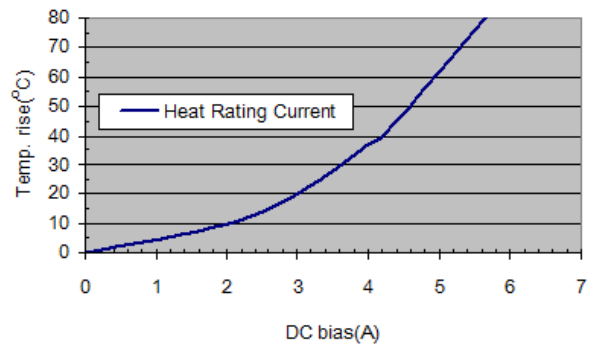
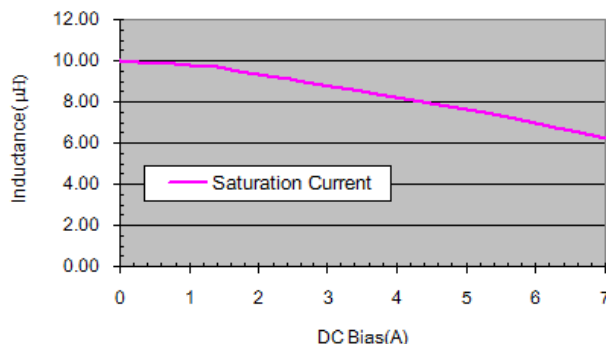

ASPI-0630LR-150

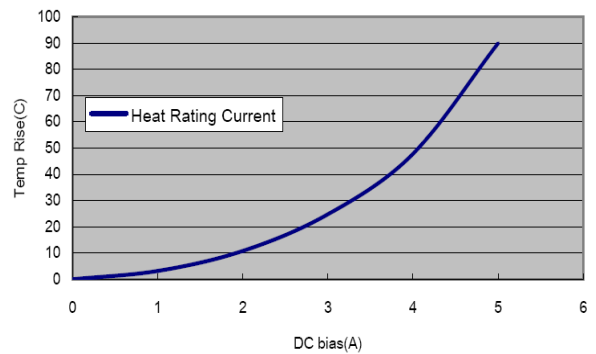
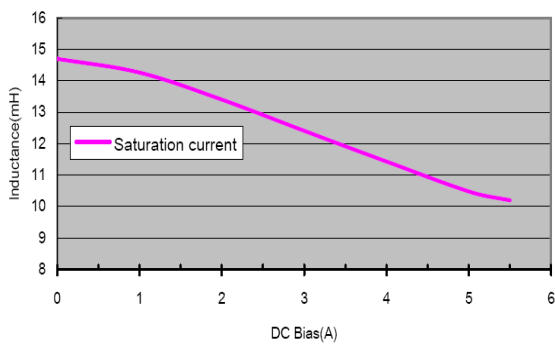

Molding Type Power Inductor

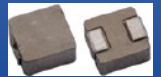

ASPI-0630LR

Request Samples



Check Inventory



7.1 x 6.60 x 2.8 mm
RoHS/RoHS II Compliant
 MSL Level = 1

ASPI-0630LR-R47

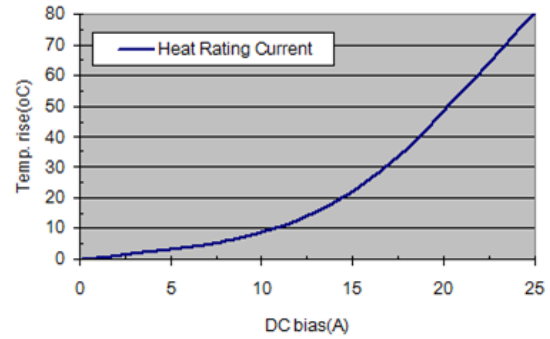
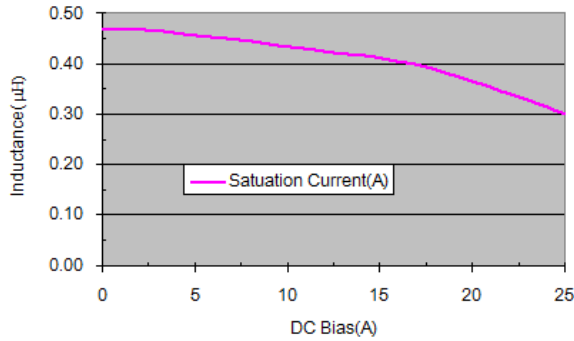

ASPI-0630LR-R56

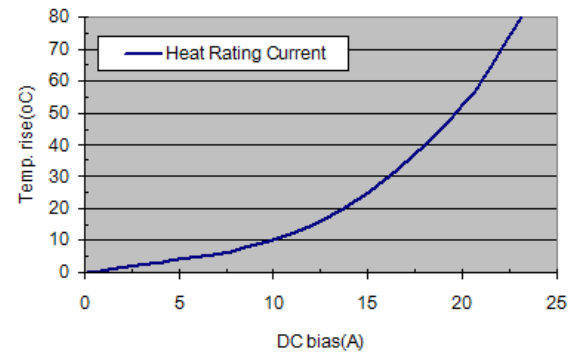
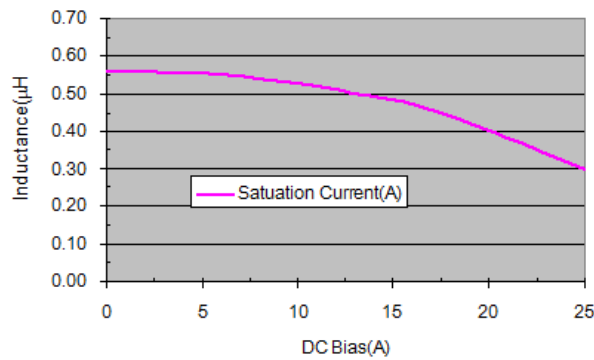

ASPI-0630LR-R68

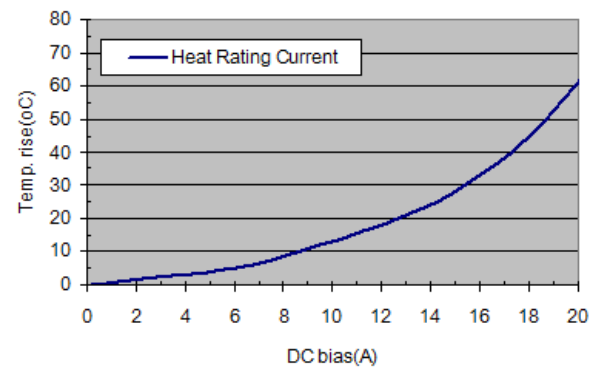
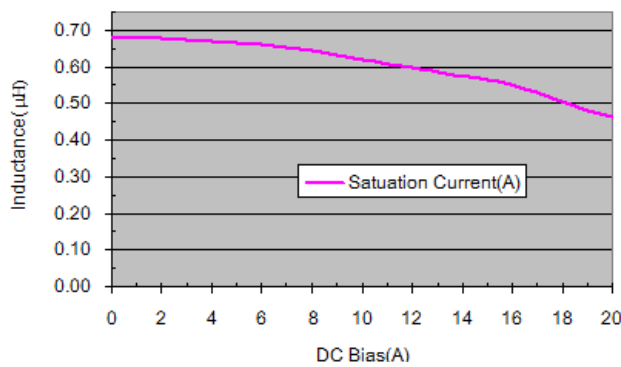

Molding Type Power Inductor

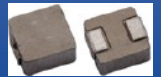

ASPI-0630LR

Request Samples



Check Inventory



7.1 x 6.60 x 2.8 mm
RoHS/RoHS II Compliant
 MSL Level = 1

ASPI-0630LR-R82

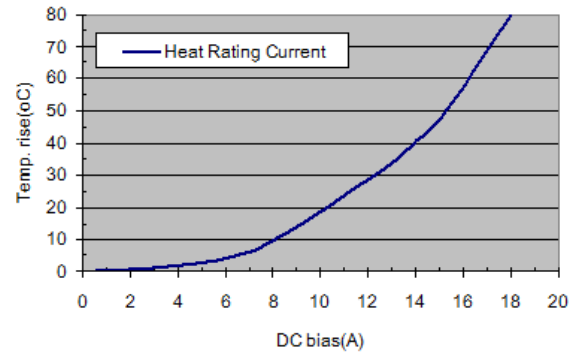
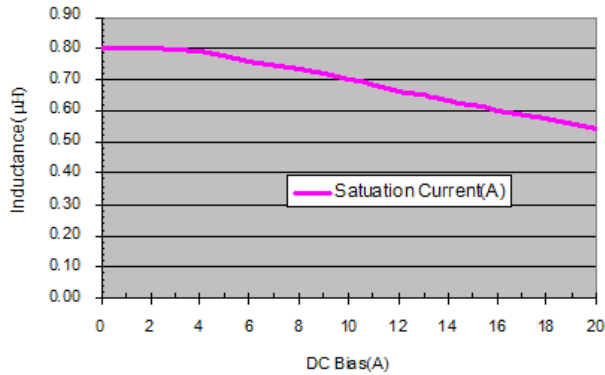

Part Identification

ASPI-0630LR- -

Inductance Code
 Please refer to the
 Electrical Spec Table

Tolerance
 M: ±20%

Packaging
 T15: Tape and Reel
 (1.5kpcs / reel)

Materials

No.	Description	Specification
a	Marking	Ink (black)
b	Core	Alloy Sponge Powder
c	Wire	Polyurethane copper wire
d	Terminal	Copper plated with Sn

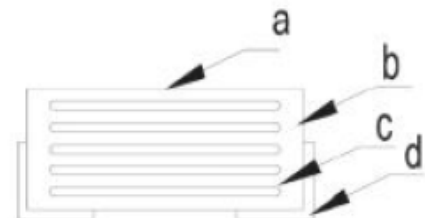

Molding Type Power Inductor

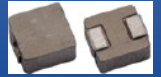

ASPI-0630LR

Request Samples



Check Inventory



7.1 x 6.60 x 2.8 mm
RoHS/RoHS II Compliant
 MSL Level = 1

Marking

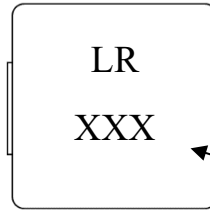

Inductance Code
 e.g. 2R2

Marking Method = Ink Marking

Mechanical Specifications

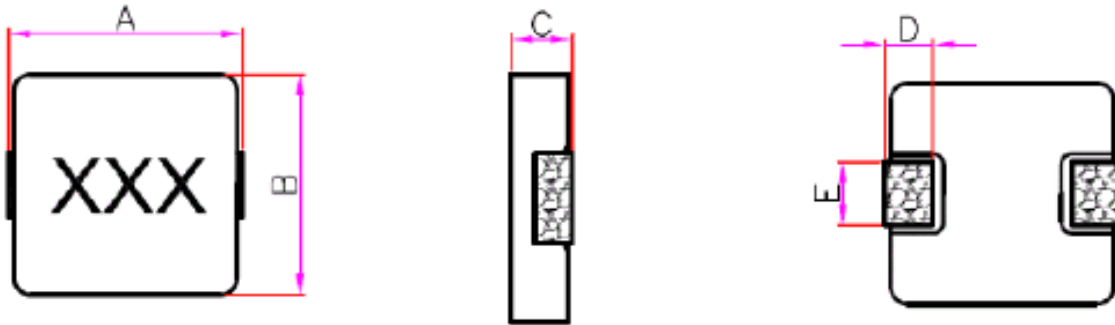

A	B	C	D	E
7.1 ±0.4	6.6 ±0.25	2.8 ±0.2	1.6 ±0.4	3.00 ±0.3

Recommended Land Pattern

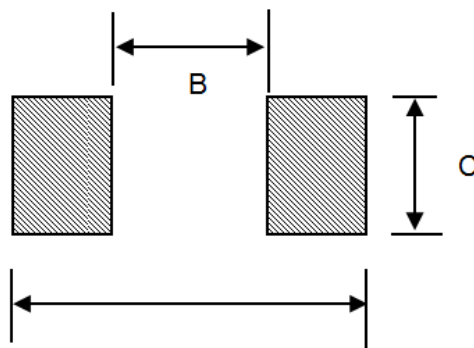

Dimension: mm

A	B	C
8.4	3.7	3.5

Molding Type Power Inductor

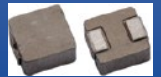

ASPI-0630LR

Request Samples



Check Inventory



7.1 x 6.60 x 2.8 mm
RoHS/RoHS II Compliant
 MSL Level = 1

Reflow Profile

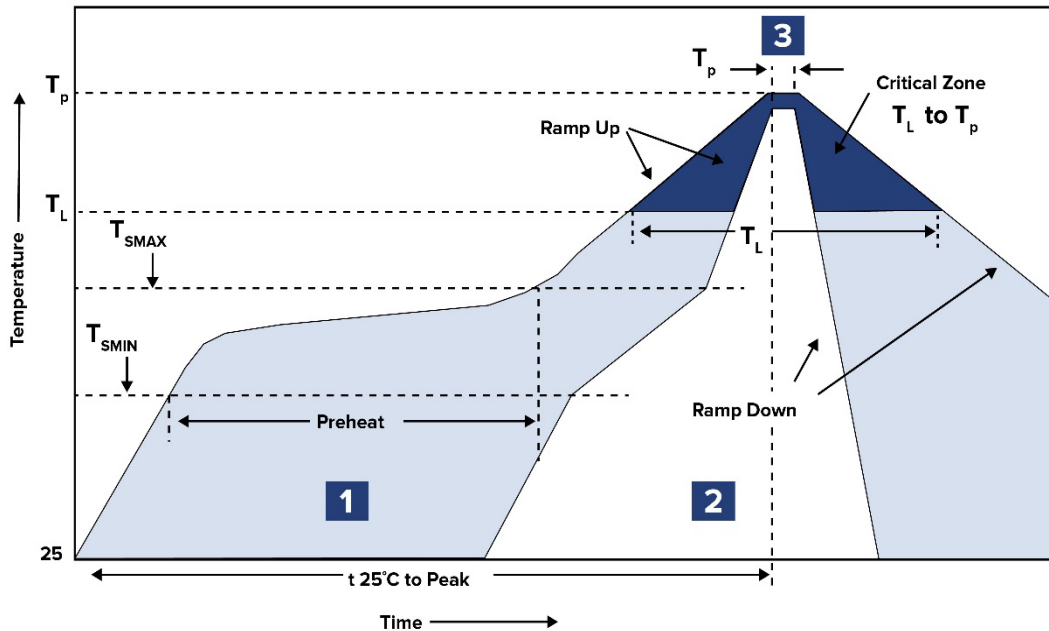

Zone	Description	Temperature	Times
1	Preheat	$T_{SMIN} \sim T_{SMAX}$ 150°C ~ 200°C	60 ~120 Sec.
2	Reflow	T_L 217°C	60 ~90 Sec.
3	Peak heat	T_P 255°C (0/ -5°C)	10 sec. Max

Molding Type Power Inductor



ASPI-0630LR

Request Samples



Check Inventory



7.1 x 6.60 x 2.8 mm
RoHS/RoHS II Compliant
 MSL Level = 1

Packing

T15: 1,500pcs / reel

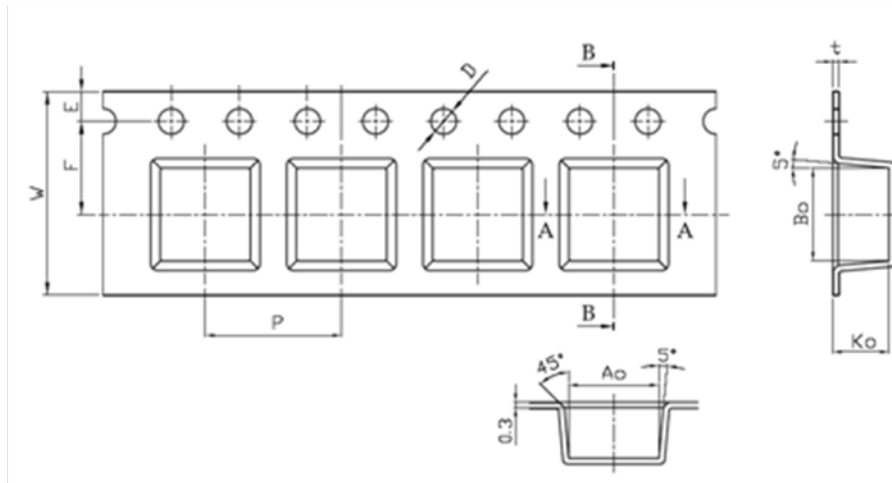

A0	6.9 ±0.3
B0	7.5
K0	3.3 ±0.3
P	12.0
t	0.35 Max
W	16
E	1.75
F	7.5
D	1.5

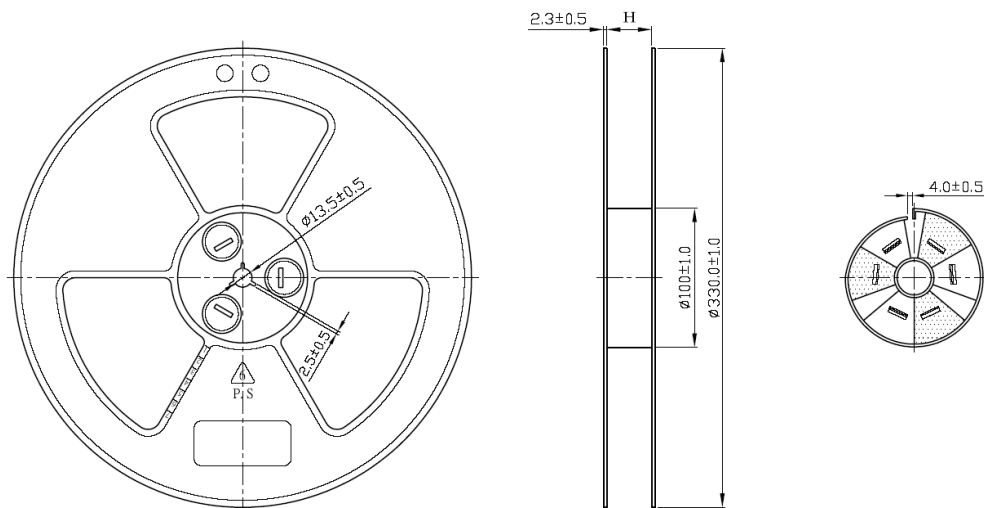

Dimension: mm

ATTENTION: Abracon LLC's products are COTS – Commercial-Off-The-Shelf products; suitable for Commercial, Industrial and, where designated, Automotive Applications. Abracon's products are not specifically designed for Military, Aviation, Aerospace, Life-dependent Medical applications or any application requiring high reliability where component failure could result in loss of life and/or property. For applications requiring high reliability and/or presenting an extreme operating environment, written consent and authorization from Abracon LLC is required. Please contact Abracon LLC for more information.



5101 Hidden Creek Ln Spicewood TX 78669
 Phone: 512-371-6159 | Fax: 512-351-8858
 For terms and conditions of sales, please visit:
www.abracon.com

REVISION: C 11-08-22

ABRACON IS
 ISO9001-2015
 CERTIFIED