

Converter - Brake - Inverter Module (CBI 1) Trench IGBT

Three Phase Rectifier	Brake Chopper	Three Phase Inverter
$V_{RRM} = 1600 \text{ V}$	$V_{CES} = 1200 \text{ V}$	$V_{CES} = 1200 \text{ V}$
$I_{DAVM25} = 151 \text{ A}$	$I_{C25} = 19 \text{ A}$	$I_{C25} = 43 \text{ A}$
$I_{FSM} = 320 \text{ A}$	$V_{CE(sat)} = 2.9 \text{ V}$	$V_{CE(sat)} = 2.5 \text{ V}$

Preliminary data

Part name (Marking on product)

MUBW45-12T6K

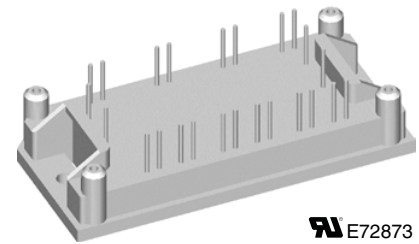
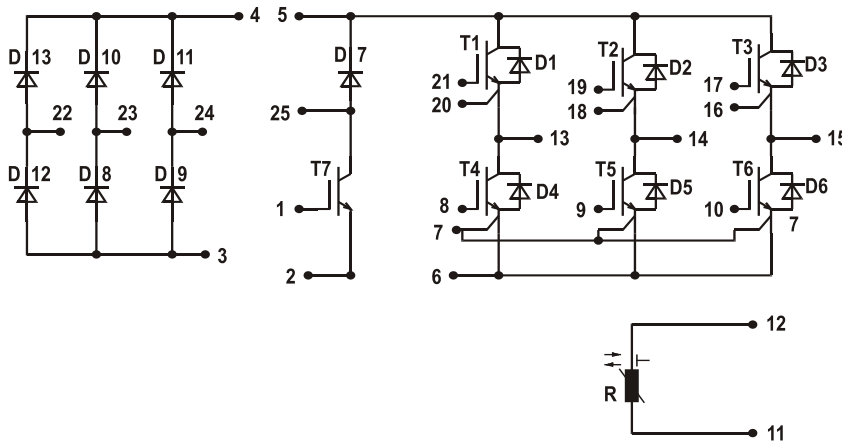

E72873

Pin configuration see outlines.

Features:

- High level of integration - only one power semiconductor module required for the whole drive
- Inverter with Trench IGBTs
 - low saturation voltage
 - positive temperature coefficient
 - fast switching
 - short tail current
- Epitaxial free wheeling diodes with hiperfast and soft reverse recovery
- Industry standard package with insulated copper base plate and soldering pins for PCB mounting
- Temperature sense included

Application:

- AC motor drives with
- Input from single or three phase grid
 - Three phase synchronous or asynchronous motor
 - Electric braking operation

Package:

- UL registered
- Industry standard E1-pack

Output Inverter T1 - T6

Symbol	Definitions	Conditions	Ratings			Unit
			min.	typ.	max.	
V_{CES}	collector emitter voltage		$T_{VJ} = 25^{\circ}\text{C}$ to 150°C			V
V_{GES}	max. DC gate voltage	continuous			± 20	V
V_{GEM}	max. transient collector gate voltage	transient			± 30	V
I_{C25}	collector current		$T_C = 25^{\circ}\text{C}$			A
I_{C80}			$T_C = 80^{\circ}\text{C}$			A
P_{tot}	total power dissipation		$T_C = 25^{\circ}\text{C}$			W
$V_{CE(sat)}$	collector emitter saturation voltage	$I_C = 45\text{ A}; V_{GE} = 15\text{ V}$	$T_{VJ} = 25^{\circ}\text{C}$			V
			$T_{VJ} = 125^{\circ}\text{C}$			V
$V_{GE(th)}$	gate emitter threshold voltage	$I_C = 1\text{ mA}; V_{GE} = V_{CE}$	$T_{VJ} = 25^{\circ}\text{C}$	5	6.5	V
I_{CES}	collector emitter leakage current	$V_{CE} = V_{CES}; V_{GE} = 0\text{ V}$	$T_{VJ} = 25^{\circ}\text{C}$			1.0 mA
			$T_{VJ} = 125^{\circ}\text{C}$			1.25 mA
I_{GES}	gate emitter leakage current	$V_{CE} = 0\text{ V}; V_{GE} = \pm 20\text{ V}$			400	nA
C_{ies}	input capacitance	$V_{CE} = 25\text{ V}; V_{GE} = 0\text{ V}; f = 1\text{ MHz}$		1810		pF
$Q_{G(on)}$	total gate charge	$V_{CE} = 600\text{ V}; V_{GE} = 15\text{ V}; I_C = 25\text{ A}$		240		nC
$t_{d(on)}$	turn-on delay time	inductive load $V_{CE} = 600\text{ V}; I_C = 25\text{ A}$ $V_{GE} = \pm 15\text{ V}; R_G = 36\ \Omega$	$T_{VJ} = 125^{\circ}\text{C}$			90 ns
t_r	current rise time		50 ns			
$t_{d(off)}$	turn-off delay time		520 ns			
t_f	current fall time		90 ns			
E_{on}	turn-on energy per pulse		2.5 mJ			
E_{off}	turn-off energy per pulse		3.4 mJ			
I_{CM}	reverse bias safe operating area	RBSOA; $V_{GE} = \pm 15\text{ V}; R_G = 36\ \Omega$ $L = 100\ \mu\text{H};$ clamped induct. load $V_{CEmax} = V_{CES} - L_S \cdot di/dt$	$T_{VJ} = 125^{\circ}\text{C}$			50 A
t_{SC} (SCSOA)	short circuit safe operating area	$V_{CE} = 900\text{ V}; V_{GE} = \pm 15\text{ V}; R_G = 36\ \Omega;$ non-repetitive	$T_{VJ} = 125^{\circ}\text{C}$			10 μs
R_{thJC}	thermal resistance junction to case	(per IGBT)			0.8	K/W
R_{thCH}	thermal resistance case to heatsink	(per IGBT)		0.3		K/W

Output Inverter D1 - D6

Symbol	Definitions	Conditions	Ratings			Unit
			min.	typ.	max.	
V_{RRM}	max. repetitive reverse voltage		$T_{VJ} = 150^{\circ}\text{C}$			1200 V
I_{F25}	forward current		$T_C = 25^{\circ}\text{C}$			49 A
I_{F80}			$T_C = 80^{\circ}\text{C}$			32 A
V_F	forward voltage	$I_F = 45\text{ A}; V_{GE} = 0\text{ V}$	$T_{VJ} = 25^{\circ}\text{C}$			3.1 V
			$T_{VJ} = 125^{\circ}\text{C}$			2.3 V
I_{RM}	max. reverse recovery current	$V_R = 600\text{ V}$ $di_F/dt = -1700\text{ A}/\mu\text{s}$ $I_F = 30\text{ A}; V_{GE} = 0\text{ V}$	$T_{VJ} = 100^{\circ}\text{C}$			51 A
t_{rr}	reverse recovery time		180 ns			
$E_{rec(off)}$	reverse recovery energy		1.8 μJ			
R_{thJC}	thermal resistance junction to case	(per diode)			0.9	K/W
R_{thCH}	thermal resistance case to heatsink	(per diode)		0.3		K/W

 $T_C = 25^{\circ}\text{C}$ unless otherwise stated

Brake Chopper T7

Symbol	Definitions	Conditions	Ratings			Unit	
			min.	typ.	max.		
V_{CES}	collector emitter voltage		$T_{VJ} = 25^{\circ}\text{C}$ to 150°C			V	
V_{GES}	max. DC gate voltage	continuous			± 20	V	
V_{GEM}	max. transient collector gate voltage	transient			± 30	V	
I_{C25}	collector current		$T_C = 25^{\circ}\text{C}$			A	
I_{C80}			$T_C = 80^{\circ}\text{C}$			A	
P_{tot}	total power dissipation		$T_C = 25^{\circ}\text{C}$			W	
$V_{CE(sat)}$	collector emitter saturation voltage	$I_C = 15\text{ A}; V_{GE} = 15\text{ V}$	$T_{VJ} = 25^{\circ}\text{C}$			V	
			$T_{VJ} = 125^{\circ}\text{C}$			V	
$V_{GE(th)}$	gate emitter threshold voltage	$I_C = 0.4\text{ mA}; V_{GE} = V_{CE}$	4.5		6.5	V	
I_{CES}	collector emitter leakage current	$V_{CE} = V_{CES}; V_{GE} = 0\text{ V}$	$T_{VJ} = 25^{\circ}\text{C}$			mA	
			$T_{VJ} = 125^{\circ}\text{C}$			mA	
I_{GES}	gate emitter leakage current	$V_{CE} = 0\text{ V}; V_{GE} = \pm 20\text{ V}$			100	nA	
C_{ies}	input capacitance	$V_{CE} = 25\text{ V}; V_{GE} = 0\text{ V}; f = 1\text{ MHz}$		600		pF	
$Q_{G(on)}$	total gate charge	$V_{CE} = 600\text{ V}; V_{GE} = 15\text{ V}; I_C = 10\text{ A}$		45		nC	
$t_{d(on)}$	turn-on delay time	} inductive load $V_{CE} = 600\text{ V}; I_C = 10\text{ A}$ $V_{GE} = \pm 15\text{ V}; R_G = 82\ \Omega$	$T_{VJ} = 125^{\circ}\text{C}$			45	ns
t_r	current rise time		40			ns	
$t_{d(off)}$	turn-off delay time		290			ns	
t_f	current fall time		60			ns	
E_{on}	turn-on energy per pulse		1.2			mJ	
E_{off}	turn-off energy per pulse		1.1			mJ	
I_{CM}	reverse bias safe operating area	RBSOA; $V_{GE} = \pm 15\text{ V}; R_G = 82\ \Omega$ $L = 100\ \mu\text{H};$ clamped induct. load $V_{CEmax} = V_{CES} - L_S \cdot di/dt$	$T_{VJ} = 125^{\circ}\text{C}$			20	A
t_{SC} (SCSOA)	short circuit safe operating area	$V_{CE} = 720\text{ V}; V_{GE} = \pm 15\text{ V};$ $R_G = 82\ \Omega;$ non-repetitive	$T_{VJ} = 125^{\circ}\text{C}$			10	μs
R_{thJC}	thermal resistance junction to case	(per IGBT)			1.35	K/W	
R_{thCH}	thermal resistance case to heatsink	(per IGBT)	0.405			K/W	

Brake Chopper D7

Symbol	Definitions	Conditions	Ratings			Unit	
			min.	typ.	max.		
V_{RRM}	max. repetitive reverse voltage		$T_{VJ} = 150^{\circ}\text{C}$			V	
I_{F25}	forward current		$T_C = 25^{\circ}\text{C}$			15	A
I_{F80}			$T_C = 80^{\circ}\text{C}$			10	A
V_F	forward voltage	$I_F = 15\text{ A}; V_{GE} = 0\text{ V}$	$T_{VJ} = 25^{\circ}\text{C}$			3.5	V
			$T_{VJ} = 125^{\circ}\text{C}$			2.0	V
I_R	reverse current	$V_R = V_{RRM}$	$T_{VJ} = 25^{\circ}\text{C}$			0.06	mA
			$T_{VJ} = 125^{\circ}\text{C}$			0.2	mA
I_{RM}	max. reverse recovery current	} $V_R = 600\text{ V}; I_F = 10\text{ A}$ $di_F/dt = -400\text{ A}/\mu\text{s}$	$T_{VJ} = 100^{\circ}\text{C}$			13	A
t_{rr}	reverse recovery time		110			ns	
R_{thJC}	thermal resistance junction to case	(per diode)			2.5	K/W	
R_{thCH}	thermal resistance case to heatsink	(per diode)	0.85			K/W	

 $T_C = 25^{\circ}\text{C}$ unless otherwise stated

Input Rectifier Bridge D8 - D13

Symbol	Definitions	Conditions	Maximum Ratings	
V_{RRM}	max. repetitive reverse voltage		1600	V
I_{FAV}	average forward current	sine 180°	$T_C = 80^\circ\text{C}$	37
I_{DAVM}	max. average DC output current	rectangular; $d = 1/3$; bridge	$T_C = 80^\circ\text{C}$	104
I_{FSM}	max. surge forward current	$t = 10\text{ ms}$; sine 50 Hz	$T_C = 25^\circ\text{C}$	320
P_{tot}	total power dissipation		$T_C = 25^\circ\text{C}$	110

Symbol	Conditions	Characteristic Values			
		min.	typ.	max.	
V_F	forward voltage	$I_F = 45\text{ A}$	$T_{VJ} = 25^\circ\text{C}$		1.41
			$T_{VJ} = 125^\circ\text{C}$		1.38
I_R	reverse current	$V_R = V_{RRM}$	$T_{VJ} = 25^\circ\text{C}$		0.02
			$T_{VJ} = 125^\circ\text{C}$	0.4	mA
R_{thJC}	thermal resistance junction to case	(per diode)	$T_{VJ} = 25^\circ\text{C}$		1.1
R_{thCH}	thermal resistance case to heatsink	(per diode)		0.35	K/W

Temperature Sensor NTC

Symbol	Definitions	Conditions	Ratings			Unit	
			min.	typ.	max.		
R_{25}	resistance		$T_C = 25^\circ\text{C}$	4.45	4.7	5.0	k Ω
$B_{25/85}$					3510		K

Module

Symbol	Definitions	Conditions	Ratings			Unit
			min.	typ.	max.	
T_{VJ}	operating temperature		-40		125	$^\circ\text{C}$
T_{VJM}	max. virtual junction temperature				150	$^\circ\text{C}$
T_{stg}	storage temperature		-40		125	$^\circ\text{C}$
V_{ISOL}	isolation voltage	$I_{ISOL} \leq 1\text{ mA}$; 50/60 Hz			2500	V~
M_d	mounting torque	(M4)	2.0		2.2	Nm
d_S	creep distance on surface		12.7			mm
d_A	strike distance through air		12.7			mm
Weight				40		g

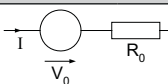
Equivalent Circuits for Simulation

Symbol	Definitions	Conditions	Ratings			Unit
			min.	typ.	max.	
V_0	rectifier diode	D8 - D13	$T_{VJ} = 125^\circ\text{C}$	0.90		V
R_0				9		m Ω
V_0	IGBT	T1 - T6	$T_{VJ} = 125^\circ\text{C}$	0.95		V
R_0				43		m Ω
V_0	free wheeling diode	D1 - D6	$T_{VJ} = 125^\circ\text{C}$	1.5		V
R_0				14		m Ω
V_0	IGBT	T7	$T_{VJ} = 125^\circ\text{C}$	1.5		V
R_0				120		m Ω
V_0	free wheeling diode	D7	$T_{VJ} = 125^\circ\text{C}$	1.46		V
R_0				63		m Ω

 $T_C = 25^\circ\text{C}$ unless otherwise stated

Outline Drawing

Dimensions in mm (1 mm = 0.0394")

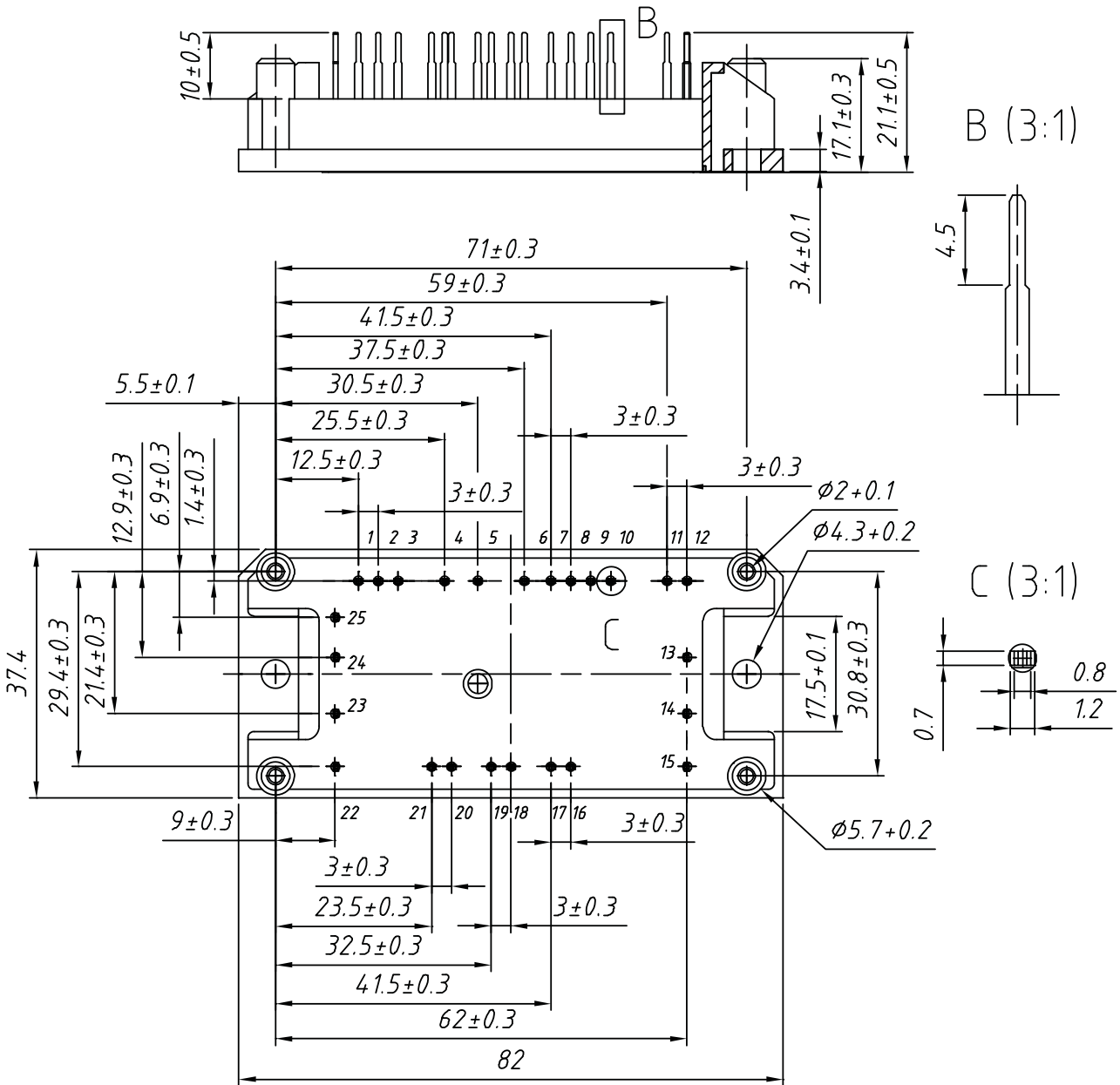

Product Marking

Ordering	Part Name	Marking on Product	Delivering Mode	Base Qty	Ordering Code
Standard	MUBW 45-12T6K	MUBW45-12T6K	Box	10	500 131

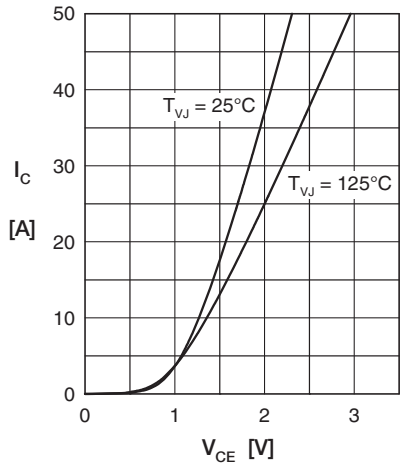

Fig. 1 Typ. output characteristics

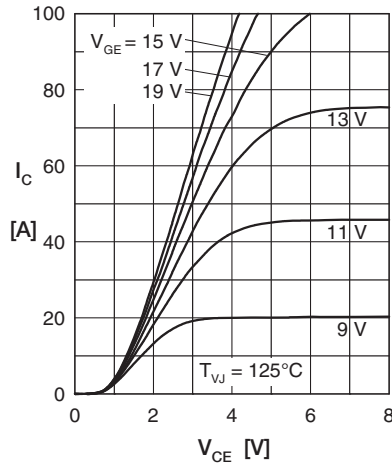

Fig. 2 Typ. output characteristics

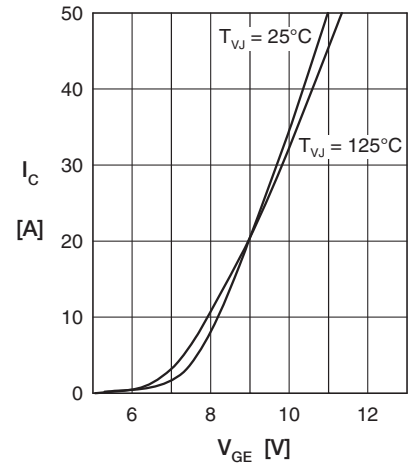

Fig. 3 Typ. transfer characteristics

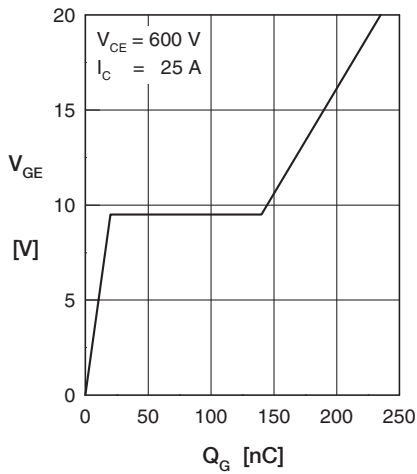

Fig. 4 Typ. turn-on gate charge

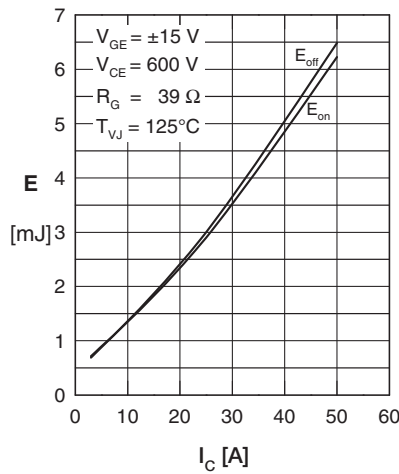

Fig. 5 Typ. switching energy vs. collector current

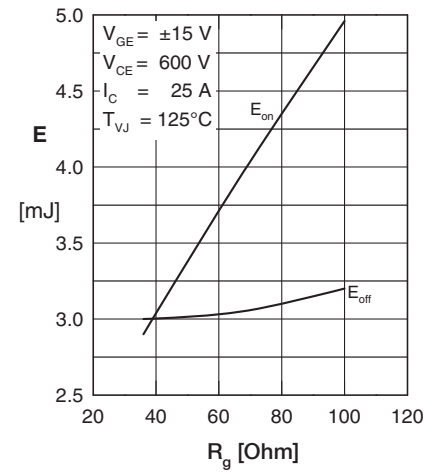

Fig. 6 Typ. switching energy vs. gate resistance

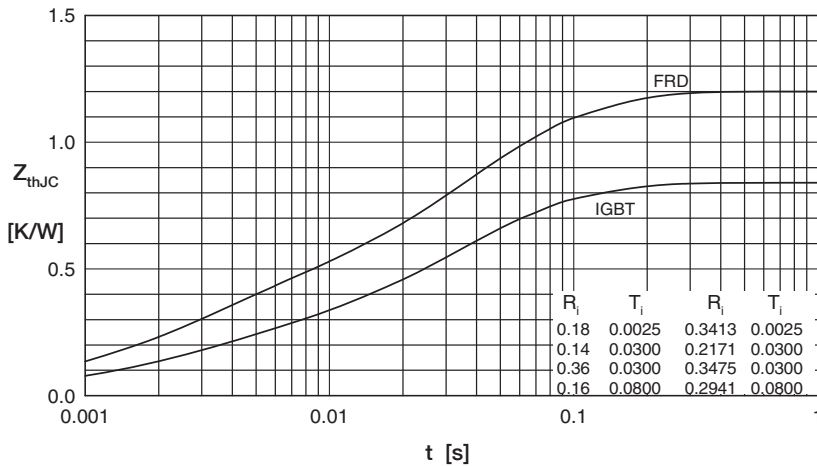

Fig. 7 Typ. transient thermal impedance

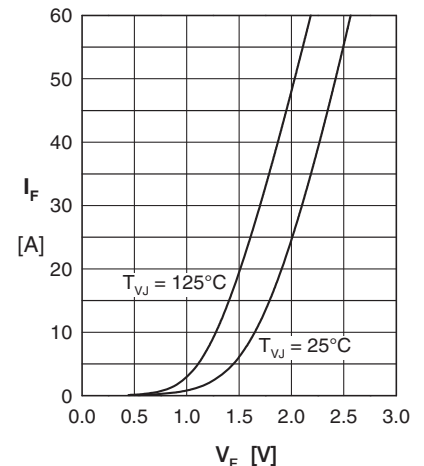

Fig. 8 Typ. forward characteristics