

26 A 600 V Snubberless Triac in TO-3PF

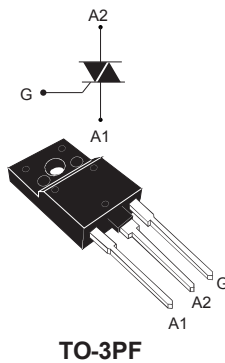

Features

- High current Triac
- Max. blocking voltage = V_{DRM} , V_{RRM} = 600 V
- Max. surge voltage = V_{DSM} , V_{RSM} = 700 V
- Snubberless high static and dynamic commutation:
 - $(di/dt)_c$ = 22 A/ms
 - dV/dt = 1000 V/ μ s
- UL recognized component at 2.5 kV for UL-1557 (File Ref. 81734)
- ECOPACK2 compliant (RoHS and HF compliance)
- UL-94, V0 flammability package resin compliance

Applications

- On/off function in static relays, heating regulation, induction motor starting circuit
- Phase control operations in light dimmers, motor speed controller and SMPS inrush current limiter

Description

Available in power package TO-3PF, the T2650-6PF Snubberless Triac is suitable for general purpose AC switching.

When used with the properly dimensioned heatsink, the T2650-6PF can enable AC switching systems up to 3 kW for 120 V AC mains. Refer to ST Application Note AN533 for thermal management of Triacs.

A Snubberless Triac, the T2650-6PF is recommended for industrial applications where high immunity and high surge current are required.

The T2650-6PF provides an insulated tab (rated at 2500 V rms). Recognized by UL, representative samples of this component have been evaluated by UL and meet applicable UL requirements for UL-1557 standard (File Ref. 81734).



Product status link

T2650-6PF

Product summary

$I_{T(RMS)}$	26 A
I_{TSM}	260 A
V_{DRM} , V_{RRM}	600 V
V_{DSM} , V_{RSM}	700 V
I_{GT}	50 mA

1 Characteristics

Table 1. Absolute maximum ratings (limiting values)

Symbol	Parameter			Value	Unit	
$I_{T(RMS)}$	RMS on-state current (full sine wave)			$T_c = 78\text{ °C}$	26	A
I_{TSM}	Non repetitive surge peak on-state current (full cycle, T_j initial = 25 °C)	$t = 16.7\text{ ms}$	$T_j = 25\text{ °C}$	270	A	
		$t = 20\text{ ms}$		260		
I^2t	I^2t value for fusing	$t_p = 10\text{ ms}$	$T_j = 25\text{ °C}$	447	A ² s	
di/dt	Critical rate of rise of on-state current, $I_G = 2 \times I_{GT}$, $tr \leq 100\text{ ns}$	$F = 50\text{ Hz}$	$T_j = 25\text{ °C}$	50	A/ μ s	
V_{DRM}/V_{RRM}	Repetitive peak off-state voltage			$T_j = 125\text{ °C}$	600	V
V_{DSM}/V_{RSM}	Non repetitive peak off-state voltage	$t_p = 10\text{ ms}$	$T_j = 25\text{ °C}$	700	V	
I_{GM}	Peak gate current	$t_p = 20\text{ }\mu$ s	$T_j = 125\text{ °C}$	4	A	
V_{GM}	Peak gate voltage			8	V	
$P_{G(AV)}$	Average gate power dissipation			$T_j = 125\text{ °C}$	1	W
T_{stg}	Storage temperature range			-40 to +150	°C	
T_j	Operating junction temperature range			-40 to +125	°C	

Table 2. Electrical characteristics ($T_j = 25\text{ °C}$, unless otherwise specified)

Symbol	Test conditions	Quadrants; T_j		Value	Unit
$I_{GT}^{(1)}$	$V_D = 12\text{ V}$, $R_L = 33\text{ }\Omega$	I - II - III	Max.	50	mA
V_{GT}			Max.	1.3	V
V_{GD}	$V_D = V_{DRM}$, $R_L = 3.3\text{ k}\Omega$, $T_j = 125\text{ °C}$	I - II - III	Min.	0.2	V
I_L	$I_G = 1.2 \times I_{GT}$	I - III	Max.	80	mA
		II	Max.	100	mA
$I_H^{(2)}$	$I_T = 500\text{ mA}$, gate open		Max.	75	mA
$dV/dt^{(2)}$	$V_D = 67\% V_{DRM}$, gate open	$T_j = 125\text{ °C}$	Min.	1000	V/ μ s
$(di/dt)_c^{(2)}$	Without snubber. $(dV/dt)_c > 20\text{ V}/\mu$ s	$T_j = 125\text{ °C}$	Min.	22	A/ms

1. Minimum I_{GT} is guaranteed at 5% of $I_{GT\text{ max}}$

2. For both polarities of A2 referenced to A1.

Table 3. Static electrical characteristics

Symbol	Test conditions	T_j		Value	Unit	
$V_{TM}^{(1)}$	$I_{TM} = 36.8\text{ A}$, $t_p = 380\text{ }\mu$ s	25 °C	Max.	1.55	V	
$V_{TO}^{(1)}$	Threshold voltage		125 °C	Max.	0.85	V
$R_D^{(1)}$	Dynamic resistance		125 °C	Max.	14	m Ω
I_{DRM} , I_{RRM}	$V_D = V_{DRM}$, $V_R = V_{RRM}$	25 °C	Max.	5	μ A	
		125 °C		4	mA	

1. For both polarities of A2 referenced to A1.

Table 4. Thermal resistance

Symbol	Parameter		Value	Unit
$R_{th(j-c)}$	Junction to case (AC)	Max.	1.60	°C/W
		Typ.	1.25	
$R_{th(j-a)}$	Junction to ambient	Typ.	50	

1.1 Characteristics (curves)

Figure 1. Maximum power dissipation versus RMS on-state current (full cycle)

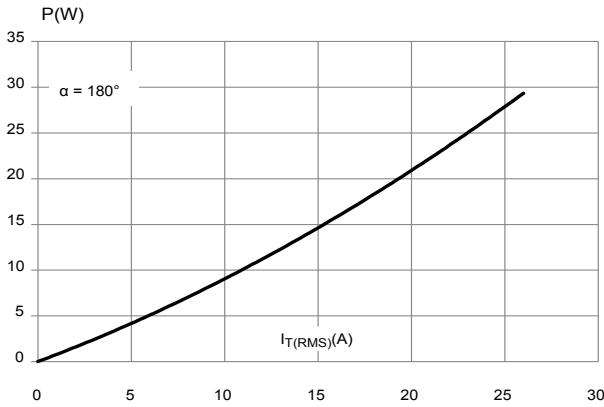

Figure 2. RMS on-state current versus case temperature (full cycle)

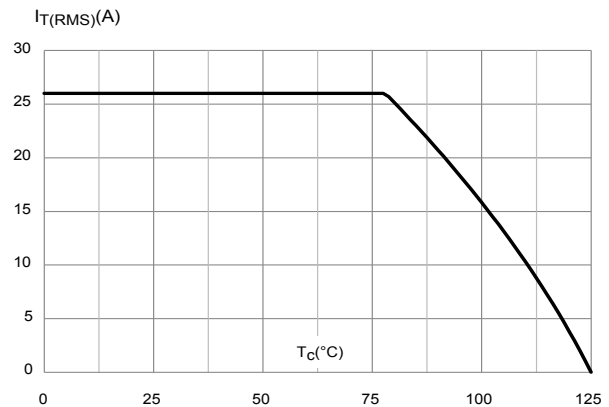

Figure 3. Relative variation of thermal impedance versus pulse duration

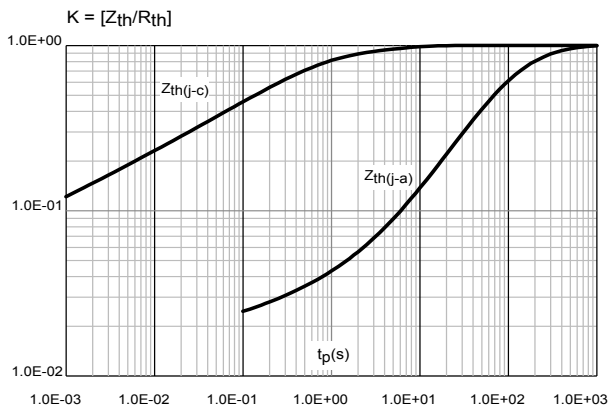

Figure 4. On-state characteristics (maximum values)

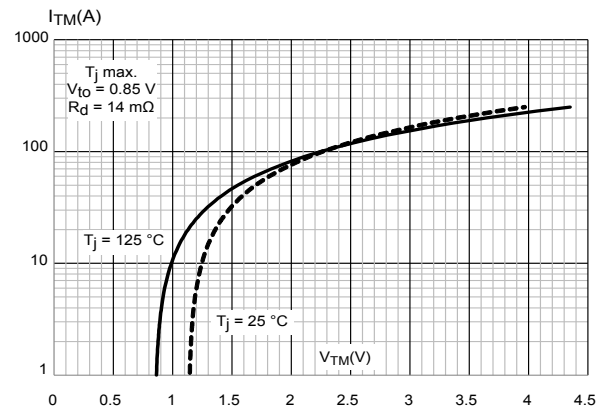

Figure 5. Surge peak on-state current versus number of cycles

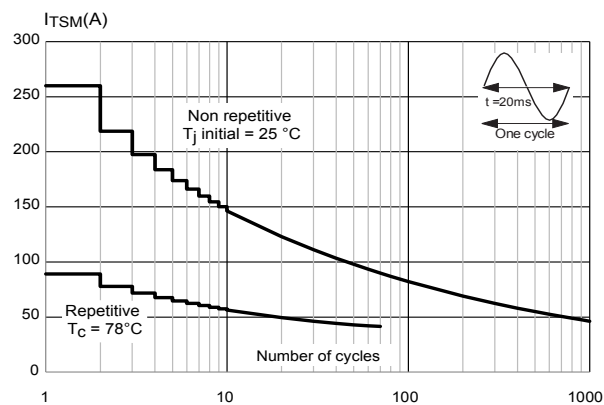

Figure 6. Non-repetitive surge peak on-state current for a sinusoidal pulse ($t_p < 10$ ms)

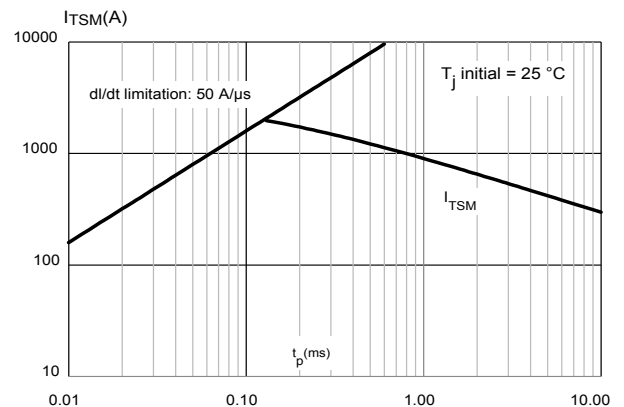

Figure 7. Relative variation of holding current and latching current versus junction temperature (typical values)

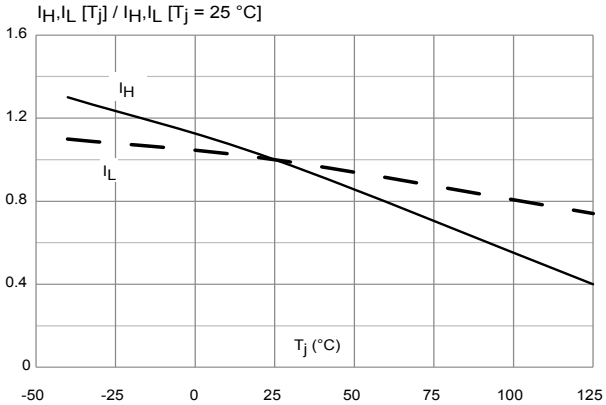

Figure 8. Relative variation of gate trigger voltage and current versus junction temperature (typical values)

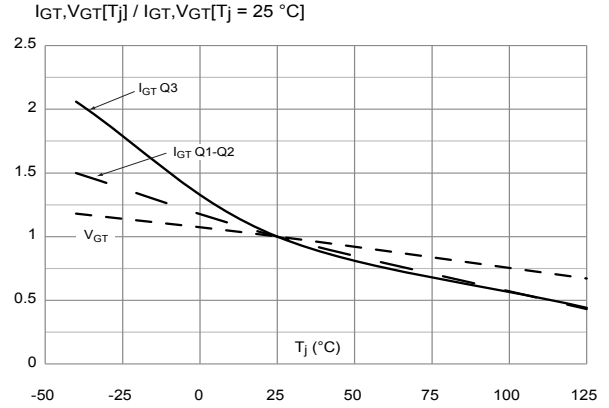

Figure 9. Relative variation of critical rate of decrease of main current $(di/dt)_c$ versus $(dV/dt)_c$ (typical values)

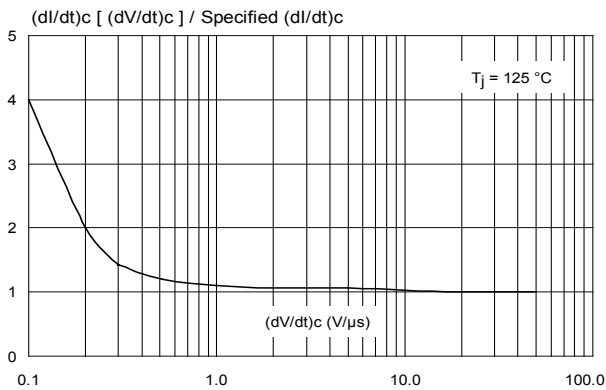

Figure 10. Relative variation of critical rate of decrease of main current versus junction temperature

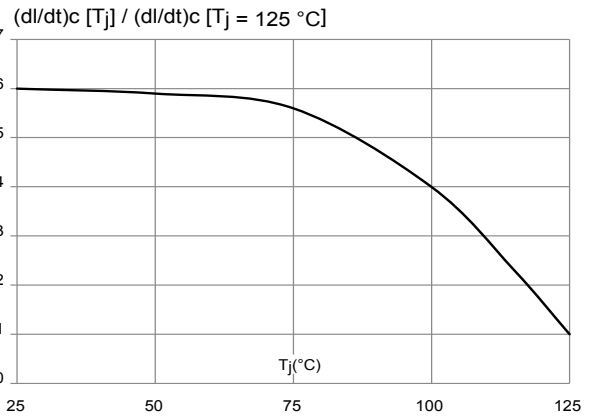

Figure 11. Relative variation of static dV/dt immunity versus junction temperature

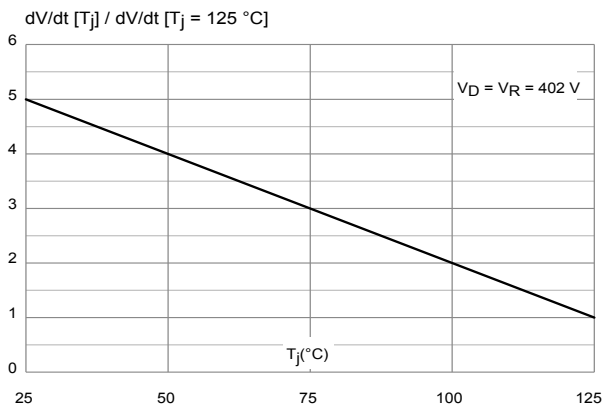
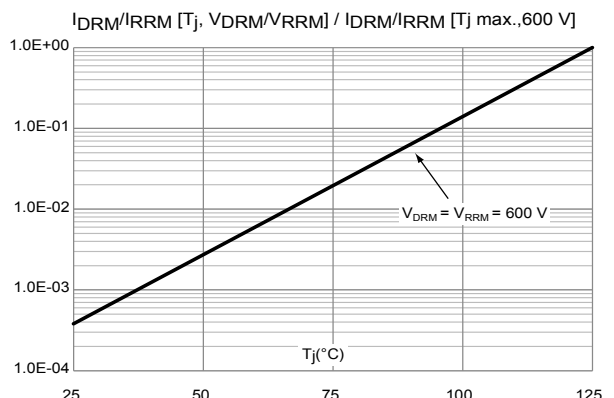

Figure 12. Relative variation of leakage current versus junction temperature



2 Package information

In order to meet environmental requirements, ST offers these devices in different grades of **ECOPACK** packages, depending on their level of environmental compliance. ECOPACK specifications, grade definitions and product status are available at: www.st.com. ECOPACK is an ST trademark.

2.1 TO-3PF package information

- Epoxy meets UL94, V0
- Lead-free package and HF package
- Recommended torque: 0.8N·m (max. 1.0 N·m)

Figure 13. TO-3PF package outline

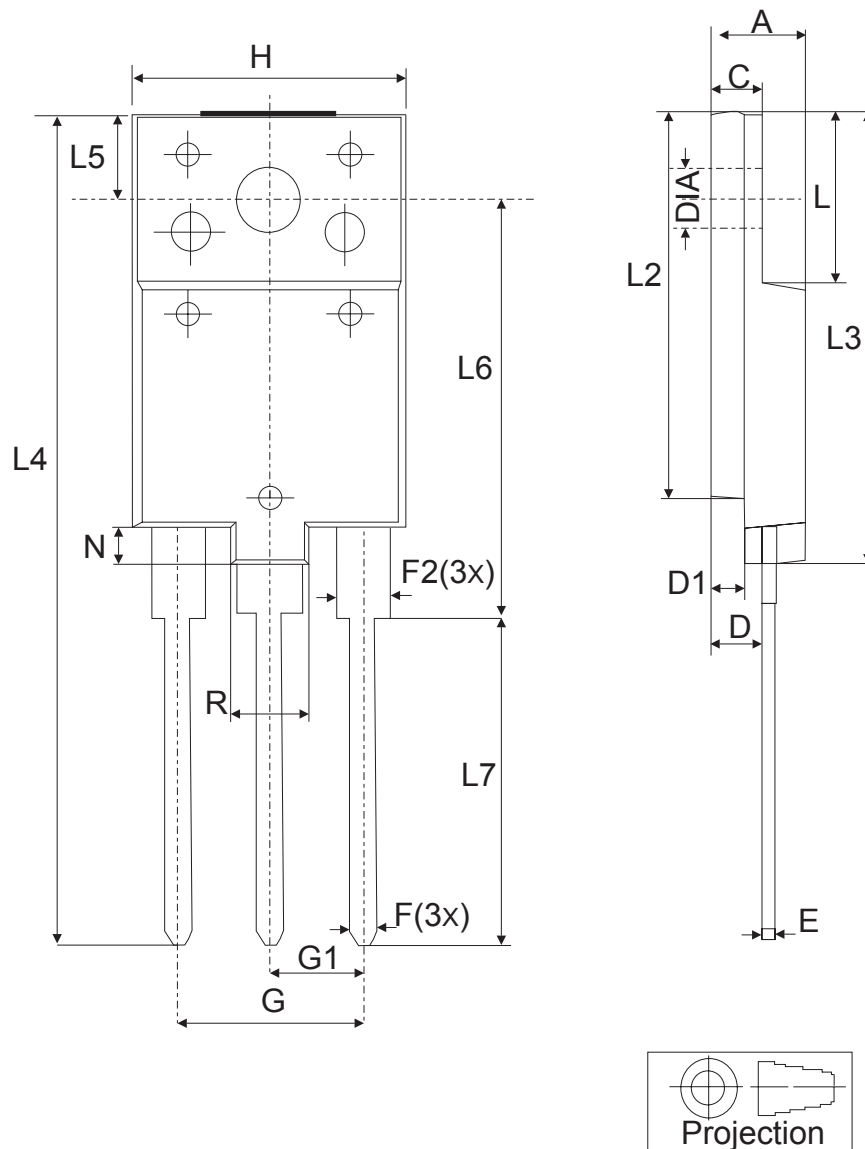

Table 5. TO-3PF mechanical data

Ref.	Dimensions					
	mm			Inches ⁽¹⁾		
	Min.	Typ.	Max.	Min.	Typ.	Max.
A	5.30		5.70	0.2087		0.2244
C	2.80		3.20	0.1102		0.1260
D	3.10		3.50	0.1220		0.1378
D1	1.80		2.20	0.0709		0.0866
E	0.80		1.10	0.0315		0.0433
F	0.65		0.95	0.0256		0.0374
F2	1.80		2.20	0.0709		0.0866
G	10.30		11.50	0.4055		0.4528
G1		5.45			0.2146	
H	15.30		15.70	0.6024		0.6181
L	9.80	10.00	10.20	0.3858	0.3937	0.4016
L2	22.80		23.20	0.8976		0.9134
L3	26.30		26.70	1.0354		0.0512
L4	43.20		44.40	1.7008		1.7480
L5	4.30		4.70	0.1693		0.1850
L6	24.30		24.70	0.9567		0.9724
L7	14.60		15.00	0.5748		0.5906
N	1.80		2.20	0.0709		0.0866
R	3.80		4.20	0.1496		0.1654
Dia	3.40		3.80	0.1339		0.1496

1. Inches given for reference only

3 Ordering information

Figure 14. Ordering information scheme

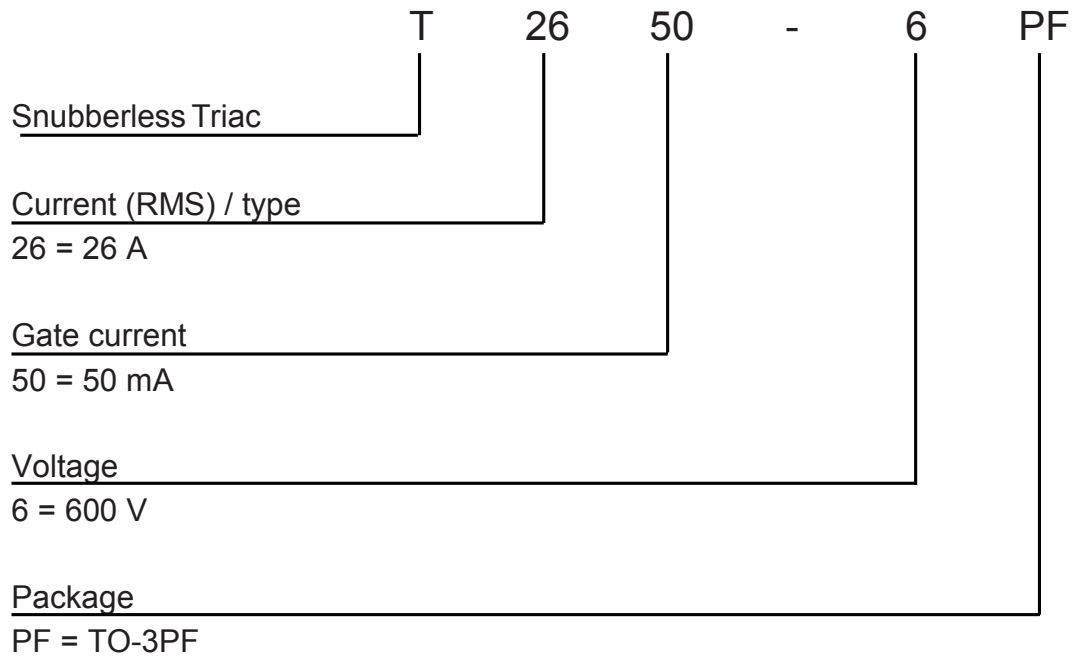

Table 6. Ordering information

Order code	Marking	Package	Weight	Base qty.	Delivery mode
T2650-6PF	T2650-6PF	TO-3PF	5.2 g	30	Tube

Revision history

Table 7. Document revision history

Date	Version	Changes
03-Dec-2020	1	Initial release.

IMPORTANT NOTICE – PLEASE READ CAREFULLY

STMicroelectronics NV and its subsidiaries (“ST”) reserve the right to make changes, corrections, enhancements, modifications, and improvements to ST products and/or to this document at any time without notice. Purchasers should obtain the latest relevant information on ST products before placing orders. ST products are sold pursuant to ST’s terms and conditions of sale in place at the time of order acknowledgement.

Purchasers are solely responsible for the choice, selection, and use of ST products and ST assumes no liability for application assistance or the design of Purchasers’ products.

No license, express or implied, to any intellectual property right is granted by ST herein.

Resale of ST products with provisions different from the information set forth herein shall void any warranty granted by ST for such product.

ST and the ST logo are trademarks of ST. For additional information about ST trademarks, please refer to www.st.com/trademarks. All other product or service names are the property of their respective owners.

Information in this document supersedes and replaces information previously supplied in any prior versions of this document.

© 2020 STMicroelectronics – All rights reserved