



## GaAs HBT MMIC 2 WATT POWER AMPLIFIER, 0.4 - 2.7 GHz

### Typical Applications

The HMC921LP4E is ideal for:

- Cellular/3G & WiMAX/LTE/4G
- Fixed Wireless & WLAN
- CATV, Cable Modem & DBS
- Microwave Radio & Test Equipment
- IF & RF Applications

### Features

- High Output IP3: +48 dBm
- High Output P1dB: +33 dBm
- High Gain: 16 dB @ 900 MHz
- Single Supply: +5V
- 32% PAE @ +33 dBm Pout
- Adjustable Bias Current
- 24 Lead 4x4 mm SMT Package: 16 mm<sup>2</sup>

### Functional Diagram

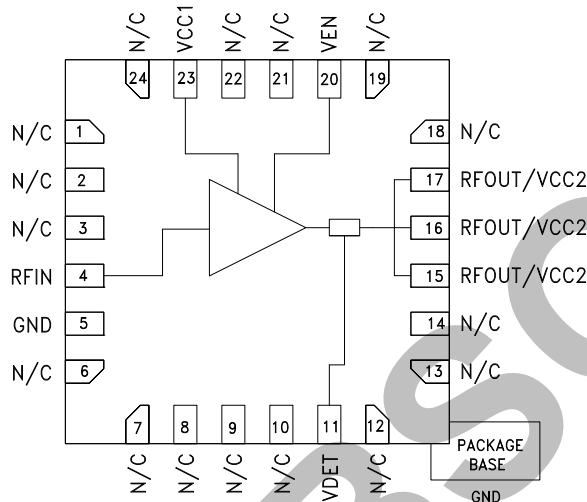

### General Description

The HMC921LP4E is a high linearity GaAs HBT MMIC 2 watt power amplifier operating from 0.4 to 2.7 GHz and is housed in a RoHS compliant 4x4 mm QFN leadless package. The HMC921LP4E utilizes a minimum number of external components and operates from a single +5V supply. This versatile power amplifier can be biased for both low quiescent current and high quiescent current modes by adjusting a single external resistor.

### Electrical Specifications, $T_A = +25^\circ\text{C}$ , $V_{cc1} = V_{cc2} = V_{EN} = +5V$ [1]

| Parameter                               | 400 mA (R1 = 270 Ω) |      |      |            |      |      |             |      |      |             |      |      |             |      |      |         |
|---|---------------------|------|------|------------|------|------|-------------|------|------|-------------|------|------|-------------|------|------|---------|
|   | Min.                | Typ. | Max. | Min.       | Typ. | Max. | Min.        | Typ. | Max. | Min.        | Typ. | Max. | Min.        | Typ. | Max. | Units   |
| Frequency Range                         | 350 - 500           |      |      | 800 - 1000 |      |      | 1800 - 2000 |      |      | 2000 - 2200 |      |      | 2500 - 2800 |      |      | MHz     |
| Gain                                    | 17                  | 19   |      | 14         | 16   |      | 9           | 11   |      | 9.5         | 10.5 |      | 8           | 9    |      | dB      |
| Gain Variation Over Temperature         |                     | 0.01 |      |            | 0.01 |      |             | 0.01 |      |             | 0.01 |      |             | 0.01 |      | dB / °C |
| Input Return Loss                       | 9                   | 12   |      | 10         | 15   |      | 5           | 10   |      | 8           | 12   |      | 6           | 11   |      | dB      |
| Output Return Loss                      | 6                   | 10   |      | 5          | 9    |      | 8           | 9    |      | 6           | 7    |      | 9           | 10   |      | dB      |
| Output Power for 1dB Compression (P1dB) | 32.5                | 34   |      | 30.5       | 32   |      | 31          | 32.5 |      | 32          | 32.5 |      | 33          | 33.3 |      | dBm     |
| Saturated Output Power (Psat)           |                     | 35   |      |            | 34   |      |             | 34   |      |             | 34   |      |             | 34.5 |      | dBm     |
| Output Third Order Intercept (IP3)      |                     | 47   |      |            | 44   |      |             | 43   |      |             | 43   |      |             | 45   |      | dBm     |
| Noise Figure                            |                     | 12.9 |      |            | 9    |      |             | 8.5  |      |             | 6.9  |      |             | 6.5  |      | dB      |
| Supply Current (Icq)                    | Ien                 |      | 8    |            | 8    |      |             | 8    |      |             | 8    |      |             | 8    |      | mA      |
|   | Icc1                |      | 12   |            | 12   |      |             | 12   |      |             | 12   |      |             | 12   |      | mA      |
|   | Icc2                |      | 400  |            | 400  |      |             | 400  |      |             | 400  |      |             | 400  |      | mA      |

[1] Specifications and data reflect HMC921LP4E measured using the respective application circuits for each designated frequency band found herein. Contact the HMC Applications Group for assistance in optimizing performance for your application.



**GaAs HBT MMIC 2 WATT POWER AMPLIFIER, 0.4 - 2.7 GHz**

**Electrical Specifications,  $T_A = +25^\circ\text{C}$ ,  $V_{cc1} = V_{cc2} = V_{EN} = +5V$  [1]**

| Parameter                               | 700 mA ( $R_1 = 130 \Omega$ ) |      |      |            |      |      |             |      |      |             |      |      |             |      |      | Units   |
|---|-------------------------------|------|------|------------|------|------|-------------|------|------|-------------|------|------|-------------|------|------|---------|
|   | Min.                          | Typ. | Max. | Min.       | Typ. | Max. | Min.        | Typ. | Max. | Min.        | Typ. | Max. | Min.        | Typ. | Max. |         |
| Frequency Range                         | 350 - 500                     |      |      | 800 - 1000 |      |      | 1800 - 2000 |      |      | 2000 - 2200 |      |      | 2600 - 2800 |      |      | MHz     |
| Gain                                    | 19                            | 19.5 |      | 14         | 16   |      | 9           | 11   |      | 10.3        | 10.8 |      | 8           | 9    |      | dB      |
| Gain Variation Over Temperature         |                               | 001  |      |            | 0.01 |      |             | 0.01 |      |             | 0.01 |      |             | 0.01 |      | dB / °C |
| Input Return Loss                       | 9                             | 12   |      | 11         | 15   |      | 6           | 10   |      | 9           | 13   |      | 6           | 12   |      | dB      |
| Output Return Loss                      | 6                             | 10   |      | 6          | 9    |      | 8           | 9    |      | 6           | 7.5  |      | 9           | 10   |      | dB      |
| Output Power for 1dB Compression (P1dB) | 33                            | 34.5 |      | 31         | 32.5 |      | 31.5        | 33   |      | 32.8        | 33.5 |      | 33          | 34   |      | dBm     |
| Saturated Output Power (Psat)           |                               | 35   |      |            | 34   |      |             | 34   |      |             | 34.5 |      |             | 35   |      | dBm     |
| Output Third Order Intercept (IP3)      |                               | 43   |      |            | 45   |      |             | 46   |      |             | 47   |      |             | 47   |      | dBm     |
| Noise Figure                            |                               | 14   |      |            | 9    |      |             | 8.5  |      |             | 8    |      |             | 8    |      | dB      |
| Supply Current (Icq)                    | Ien                           |      |      |            | 13   |      |             | 13   |      |             | 13   |      |             | 13   |      | mA      |
|   | Icc1                          |      |      |            | 14   |      |             | 14   |      |             | 14   |      |             | 14   |      | mA      |
|   | Icc2                          |      |      |            | 700  |      |             | 700  |      |             | 700  |      |             | 700  |      | mA      |

[1] Specifications and data reflect HMC921LP4E measured using the respective application circuits for each designated frequency band found herein. Contact the HMC Applications Group for assistance in optimizing performance for your application.

**450 MHz Tune**

**Broadband Gain & Return Loss @ 400mA**

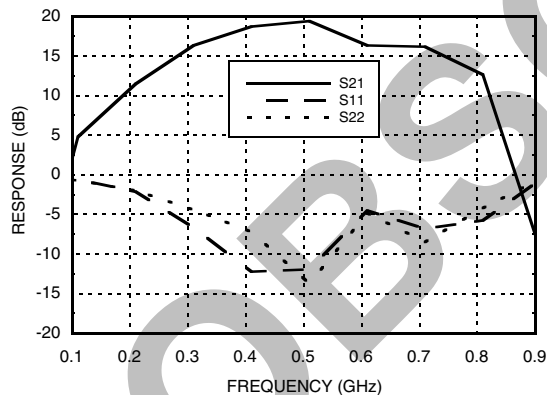

**Broadband Gain & Return Loss @ 700mA**

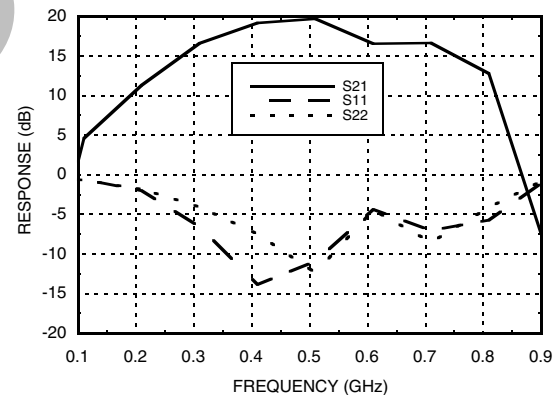

**Gain vs. Temperature @ 400mA**

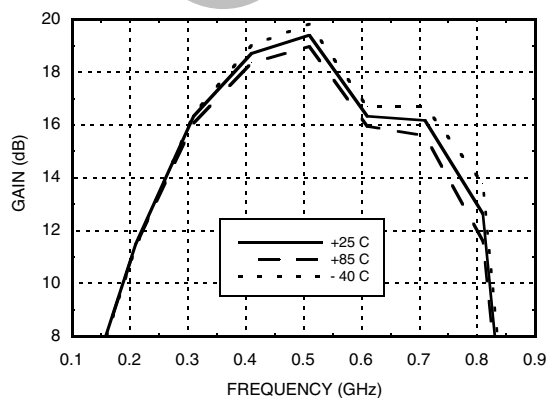

**Gain vs. Temperature @ 700mA**

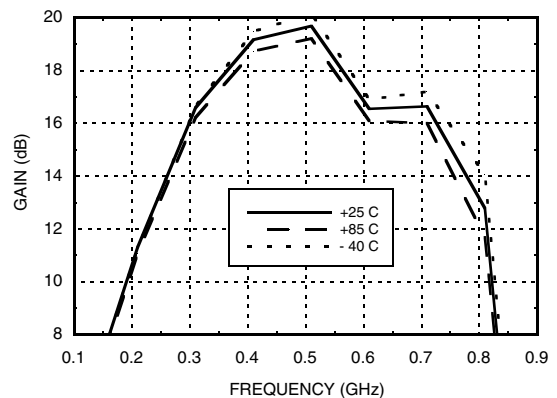

Information furnished by Analog Devices is believed to be accurate and reliable. However, no responsibility is assumed by Analog Devices for its use, nor for any infringements of patents or other rights of third parties that may result from its use. Specifications subject to change without notice. No license is granted by implication or otherwise under any patent or patent rights of Analog Devices. Trademarks and registered trademarks are the property of their respective owners.

For price, delivery, and to place orders: Analog Devices, Inc., One Technology Way, P.O. Box 9106, Norwood, MA 02062-9106 Phone: 781-329-4700 • Order online at [www.analog.com](http://www.analog.com) Application Support: Phone: 1-800-ANALOG-D



**GaAs HBT MMIC 2 WATT  
POWER AMPLIFIER, 0.4 - 2.7 GHz**

**450 MHz Tune**

**Input Return Loss @ 400 mA**

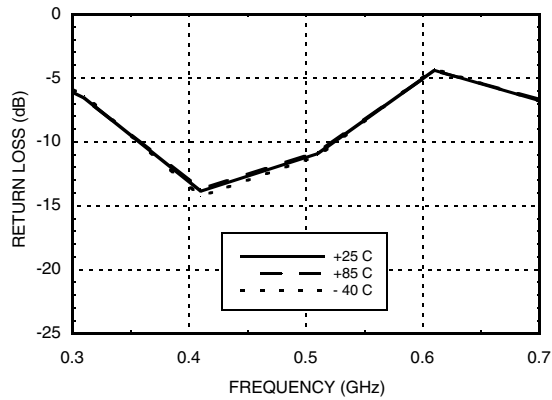

**Input Return Loss @ 700 mA**

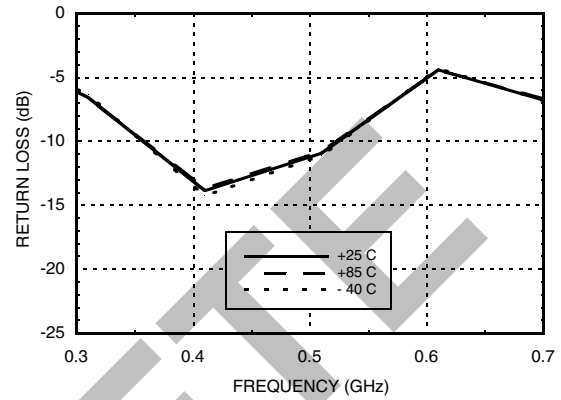

**Output return Loss @ 400 mA**

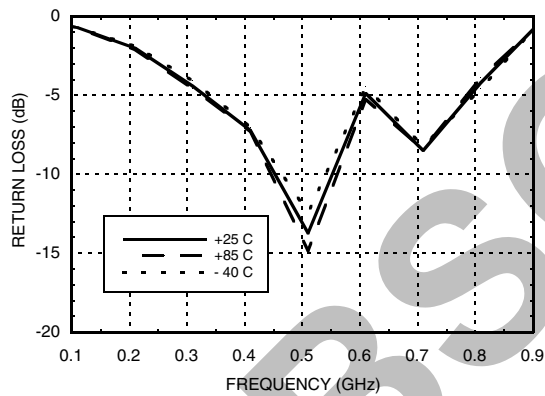

**Output return Loss @ 700 mA**

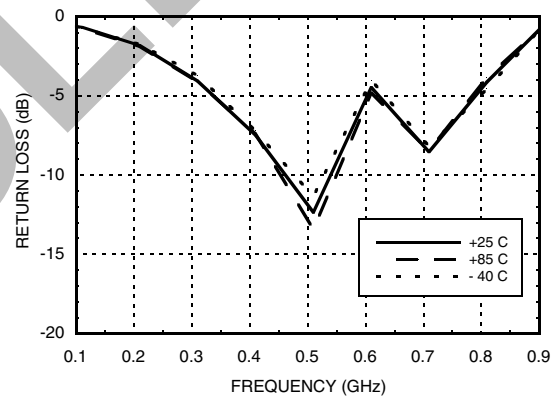

**P1dB vs. Temperature @ 400 mA**

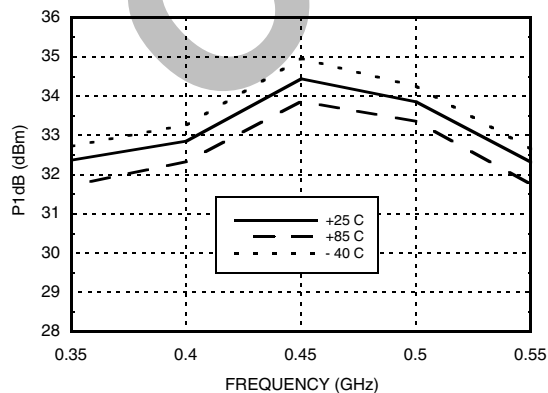

**P1dB vs. Temperature @ 700 mA**

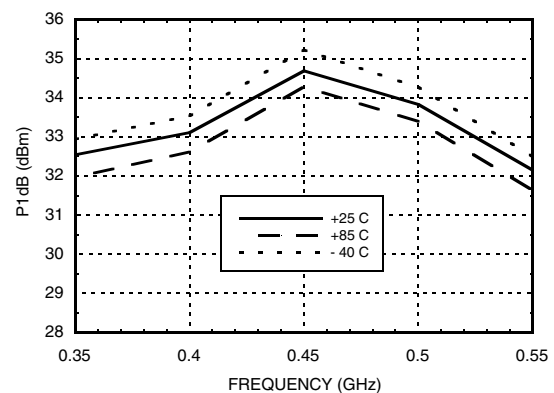

Information furnished by Analog Devices is believed to be accurate and reliable. However, no responsibility is assumed by Analog Devices for its use, nor for any infringements of patents or other rights of third parties that may result from its use. Specifications subject to change without notice. No license is granted by implication or otherwise under any patent or patent rights of Analog Devices. Trademarks and registered trademarks are the property of their respective owners.

For price, delivery, and to place orders: Analog Devices, Inc., One Technology Way, P.O. Box 9106, Norwood, MA 02062-9106 Phone: 781-329-4700 • Order online at [www.analog.com](http://www.analog.com) Application Support: Phone: 1-800-ANALOG-D



**GaAs HBT MMIC 2 WATT POWER AMPLIFIER, 0.4 - 2.7 GHz**

**450 MHz Tune**

**Psat vs. Temperature @ 400mA**

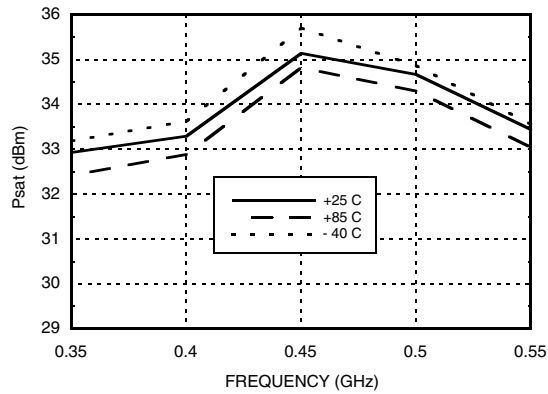

**Psat vs. Temperature @ 700mA**

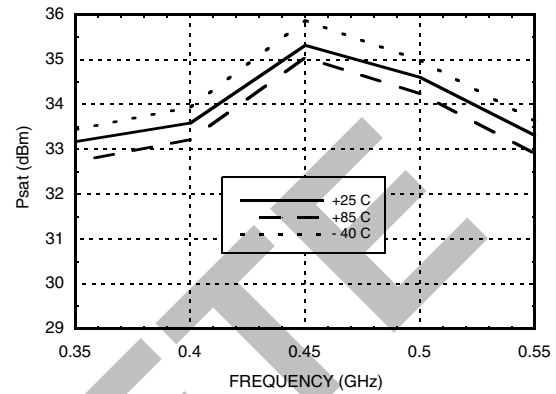

**Output IP3 vs. Output Power @ 400mA**

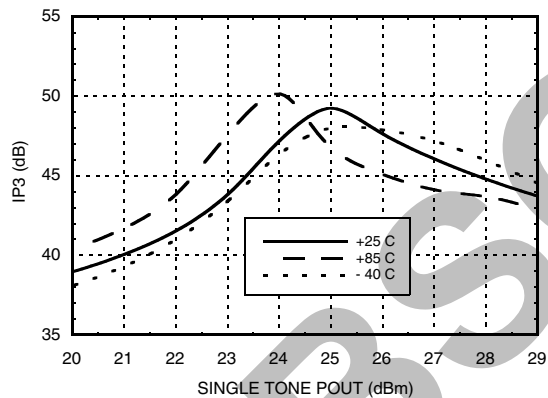

**Output IP3 vs. Output Power @ 700mA**

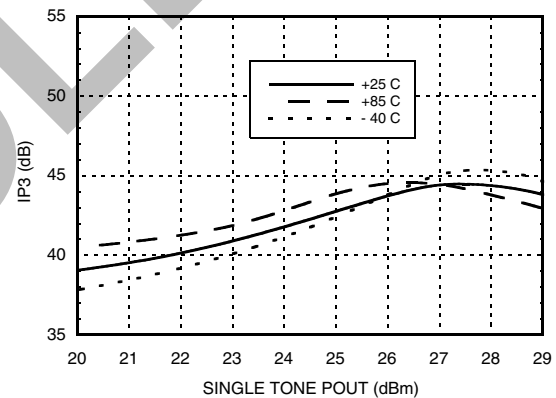

**Noise Figure vs. Temperature @ 400mA**

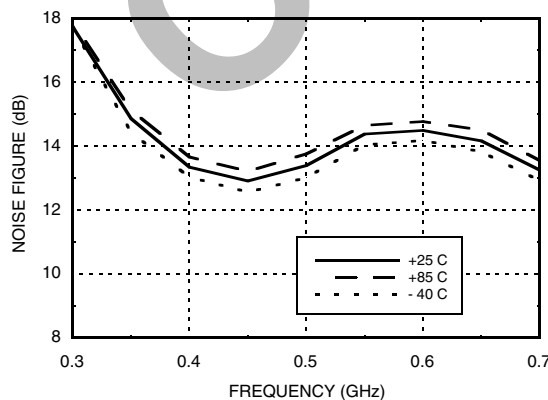

**Noise Figure vs. Temperature @ 700mA**

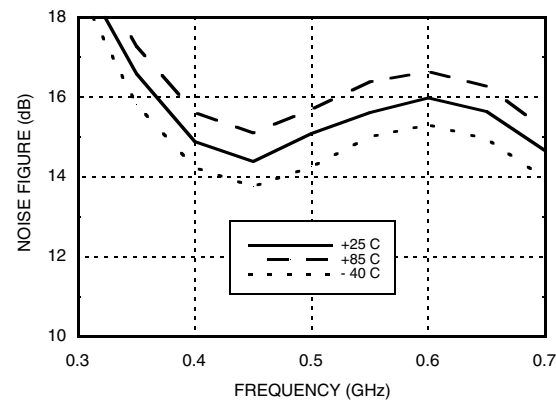



**GaAs HBT MMIC 2 WATT  
POWER AMPLIFIER, 0.4 - 2.7 GHz  
450 MHz Tune**

**Reverse Isolation vs. Temperature 400mA**

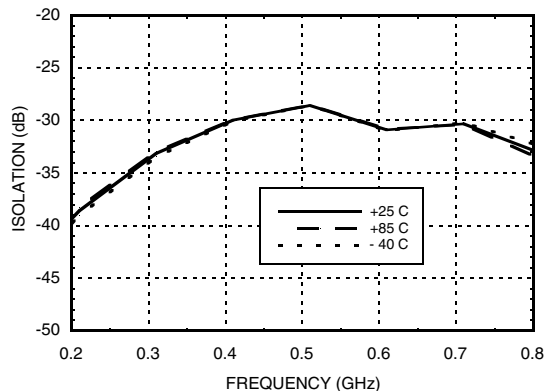

**Reverse Isolation vs. Temperature 700mA**

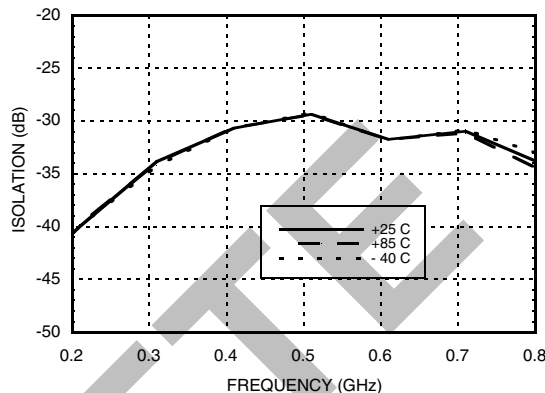

**Power Compression @ 400mA**

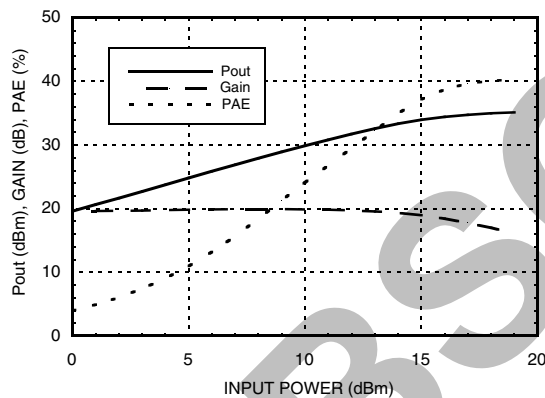

**Power Compression @ 700mA**

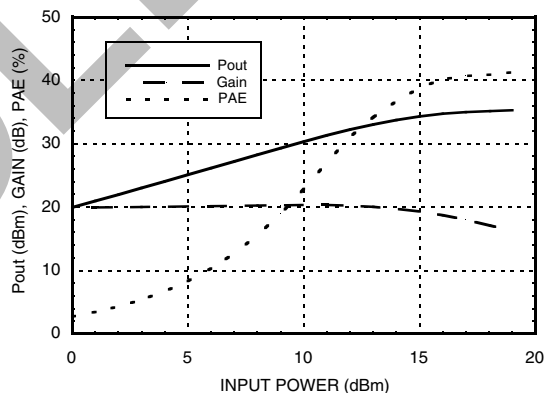



**GaAs HBT MMIC 2 WATT  
POWER AMPLIFIER, 0.4 - 2.7 GHz  
900 MHz Tune**

**Broadband Gain & Return Loss @ 400 mA**

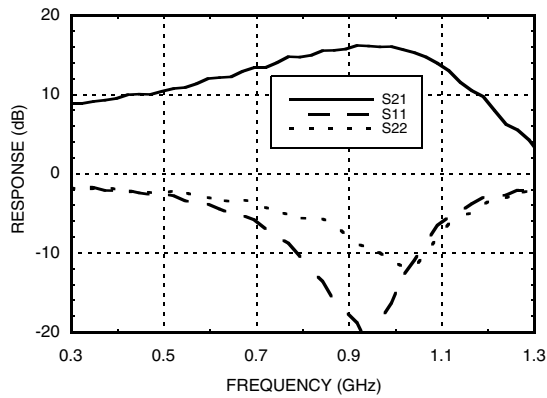

**Broadband Gain & Return Loss @ 700 mA**

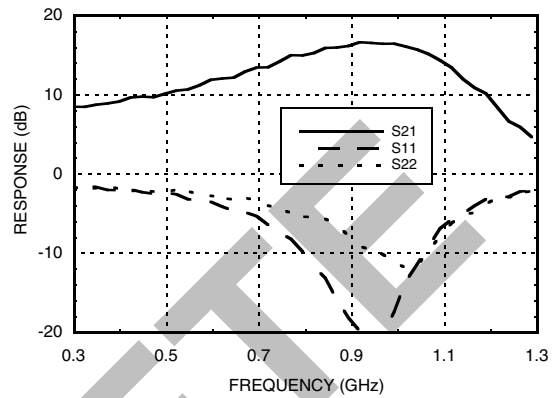

**Gain vs. Temperature @ 400 mA**

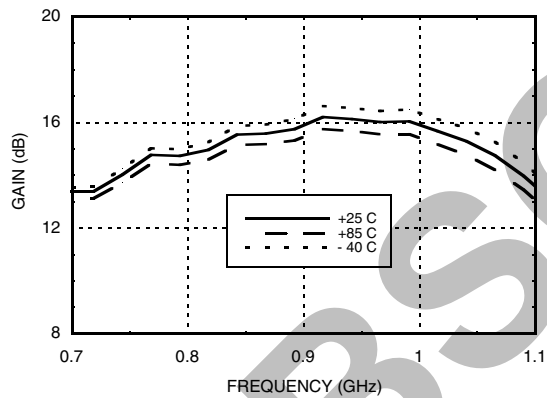

**Gain vs. Temperature @ 700 mA**

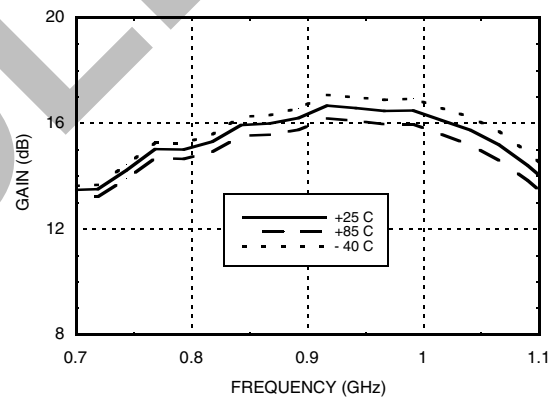

**Input Return Loss vs. Temperature 400mA**

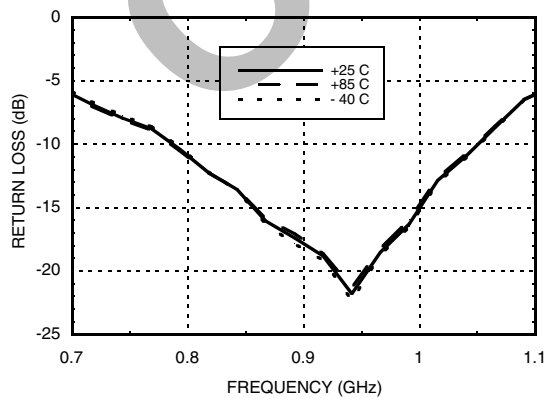

**Input Return Loss vs. Temperature 700mA**

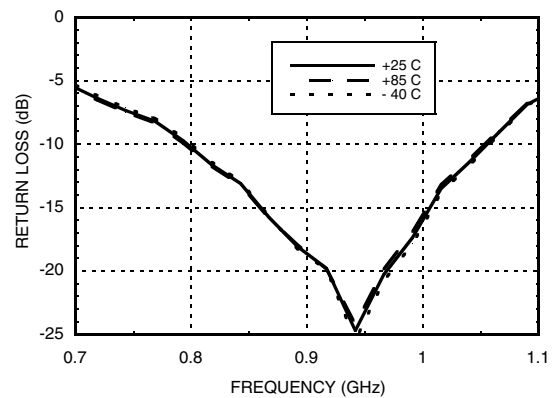



**GaAs HBT MMIC 2 WATT  
POWER AMPLIFIER, 0.4 - 2.7 GHz  
900 MHz Tune**

**Output Return Loss @ 400mA**

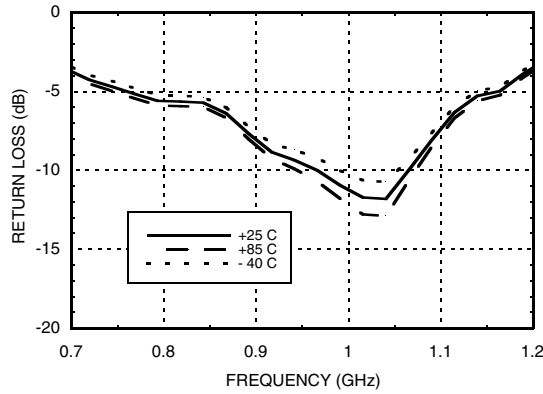

**Output Return Loss @ 700mA**

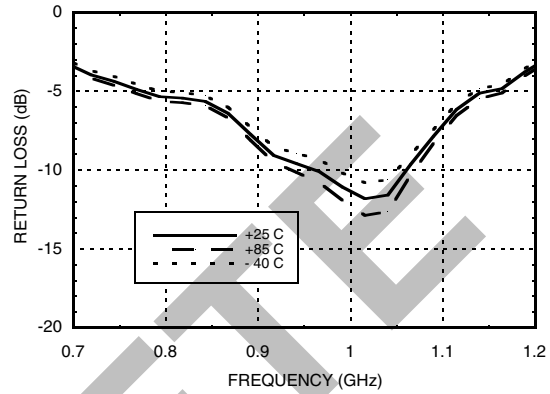

**P1dB vs. Temperature @ 400 mA**

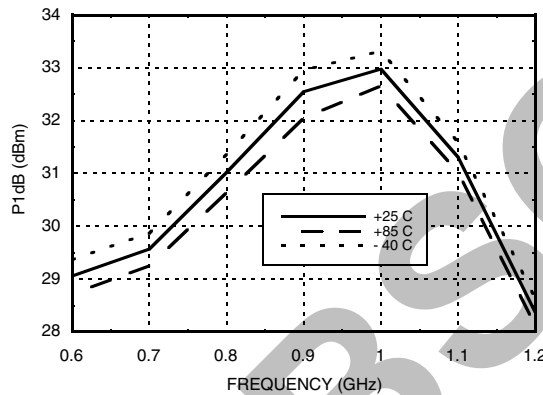

**P1dB vs. Temperature @ 700 mA**

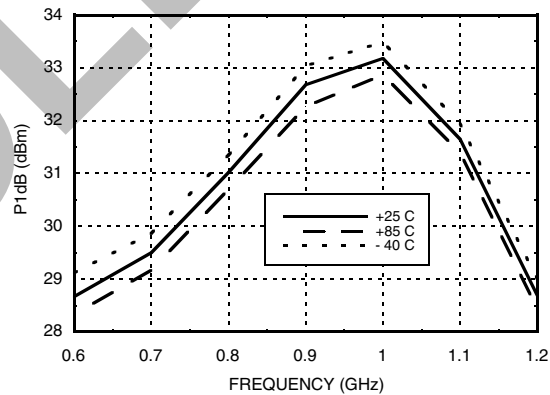

**Psat vs. Temperature @ 400 mA**

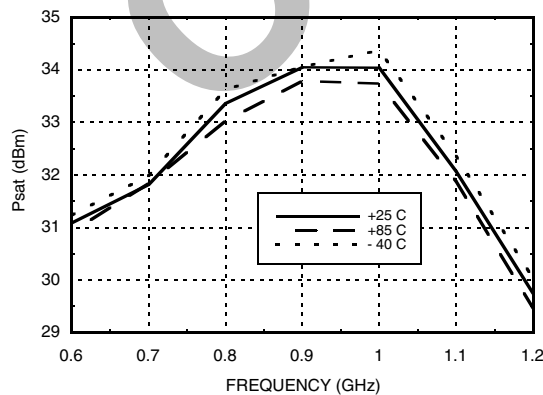

**Psat vs. Temperature @ 700 mA**

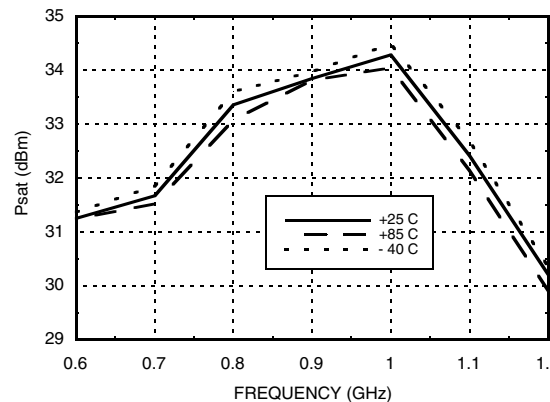

Information furnished by Analog Devices is believed to be accurate and reliable. However, no responsibility is assumed by Analog Devices for its use, nor for any infringements of patents or other rights of third parties that may result from its use. Specifications subject to change without notice. No license is granted by implication or otherwise under any patent or patent rights of Analog Devices. Trademarks and registered trademarks are the property of their respective owners.

For price, delivery, and to place orders: Analog Devices, Inc., One Technology Way, P.O. Box 9106, Norwood, MA 02062-9106 Phone: 781-329-4700 • Order online at [www.analog.com](http://www.analog.com) Application Support: Phone: 1-800-ANALOG-D



**GaAs HBT MMIC 2 WATT  
POWER AMPLIFIER, 0.4 - 2.7 GHz  
900 MHz Tune**

**Power Compression @ 400 mA**

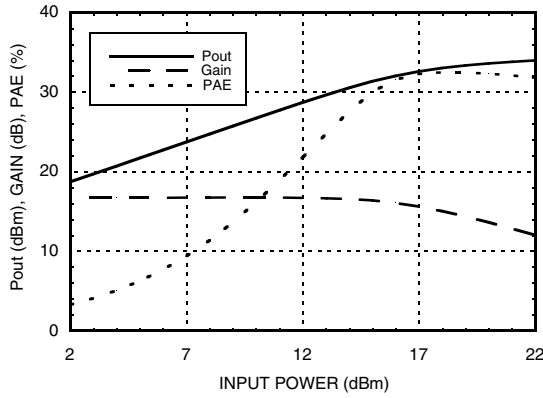

**Power Compression @ 700 mA**

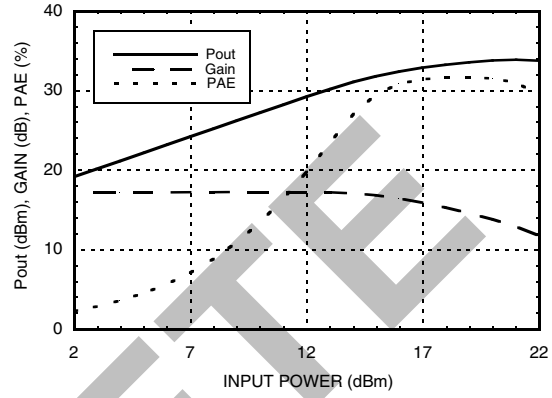

**Output IP3 vs. Output Power @ 400 mA**

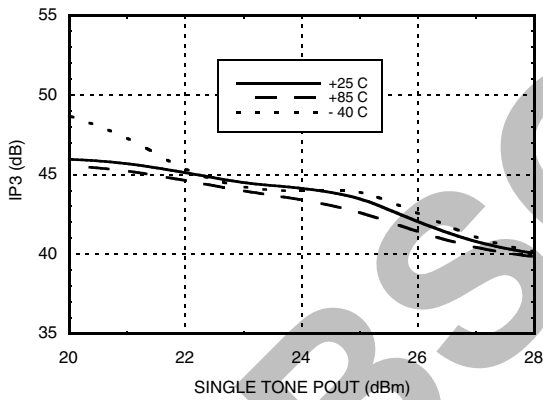

**Output IP3 vs. Output Power @ 700 mA**

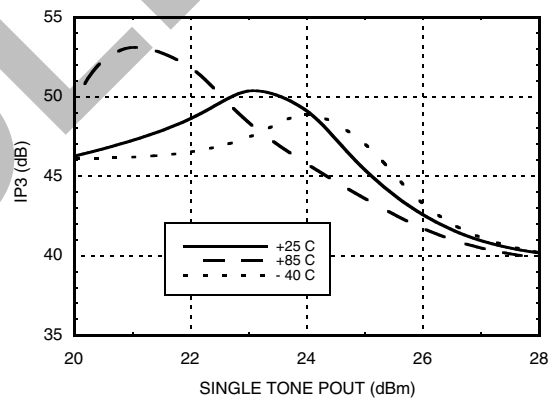

**Noise Figure vs. Temperature 400 mA**

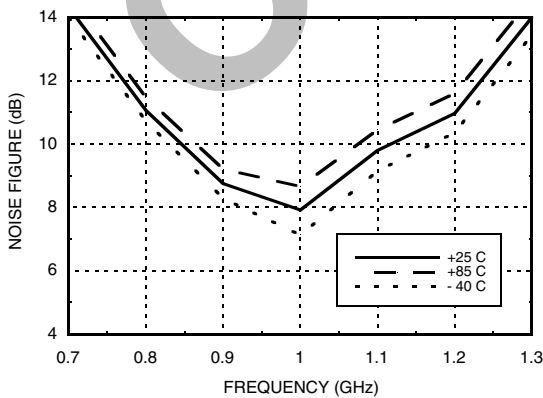

**Noise Figure vs. Temperature 700 mA**

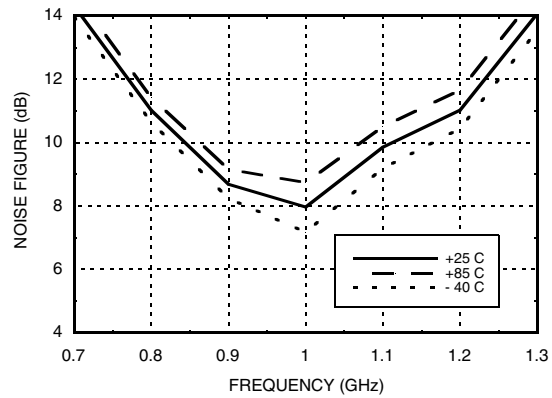

Information furnished by Analog Devices is believed to be accurate and reliable. However, no responsibility is assumed by Analog Devices for its use, nor for any infringements of patents or other rights of third parties that may result from its use. Specifications subject to change without notice. No license is granted by implication or otherwise under any patent or patent rights of Analog Devices. Trademarks and registered trademarks are the property of their respective owners.

For price, delivery, and to place orders: Analog Devices, Inc., One Technology Way, P.O. Box 9106, Norwood, MA 02062-9106 Phone: 781-329-4700 • Order online at [www.analog.com](http://www.analog.com) Application Support: Phone: 1-800-ANALOG-D





**GaAs HBT MMIC 2 WATT  
POWER AMPLIFIER, 0.4 - 2.7 GHz  
900 MHz Tune**

**Reverse Isolation vs. Temperature 400mA**

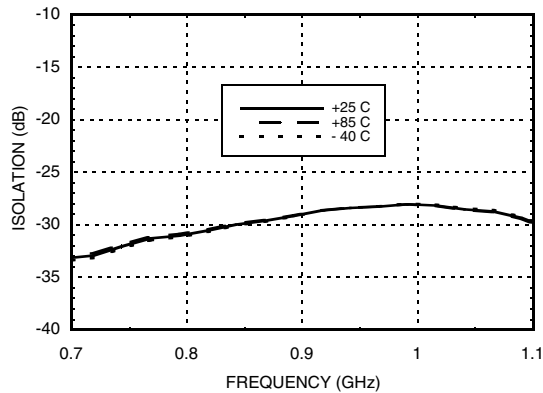

**Reverse Isolation vs. Temperature 700mA**

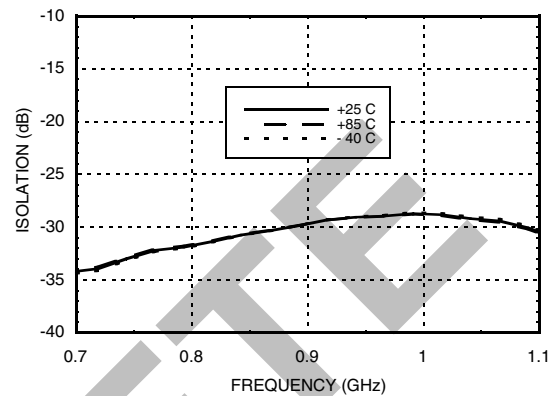

**ACPR vs. Temperature @ 880 MHz  
CDMA 2000, 9 Channels Forward, 400 mA**

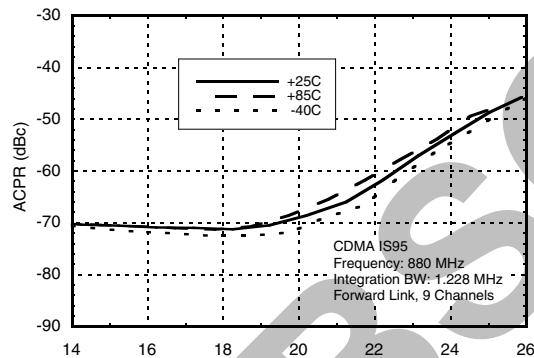

**ACPR vs. Temperature @ 880 MHz  
CDMA 2000, 9 Channels Forward, 700 mA**

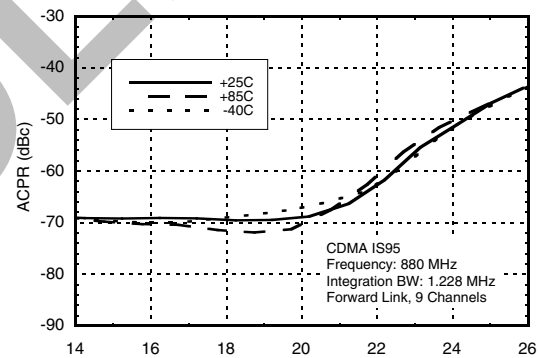

**Output IP3 vs. Bias Current**

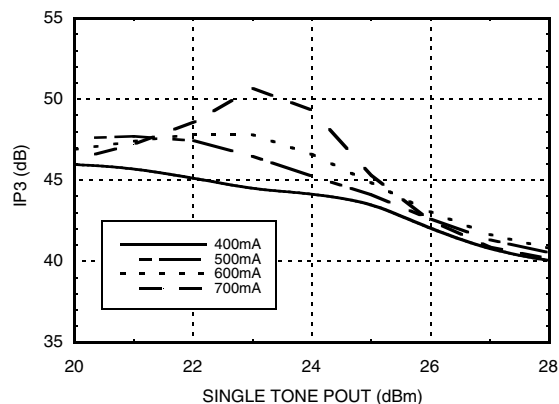

Information furnished by Analog Devices is believed to be accurate and reliable. However, no responsibility is assumed by Analog Devices for its use, nor for any infringements of patents or other rights of third parties that may result from its use. Specifications subject to change without notice. No license is granted by implication or otherwise under any patent or patent rights of Analog Devices. Trademarks and registered trademarks are the property of their respective owners.

For price, delivery, and to place orders: Analog Devices, Inc., One Technology Way, P.O. Box 9106, Norwood, MA 02062-9106  
Phone: 781-329-4700 • Order online at [www.analog.com](http://www.analog.com)  
Application Support: Phone: 1-800-ANALOG-D



**GaAs HBT MMIC 2 WATT  
POWER AMPLIFIER, 0.4 - 2.7 GHz  
1900 MHz Tune**

**Broadband Gain & Return Loss @ 400 mA**

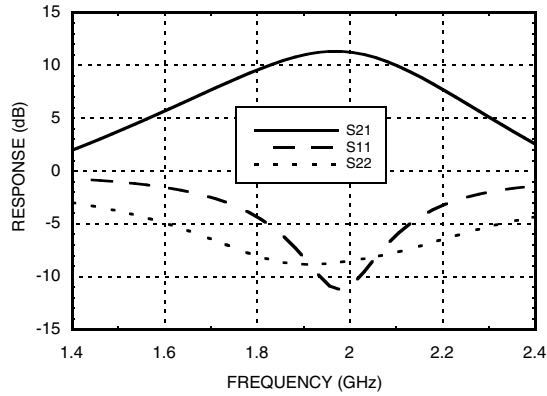

**Broadband Gain & Return Loss @ 700 mA**

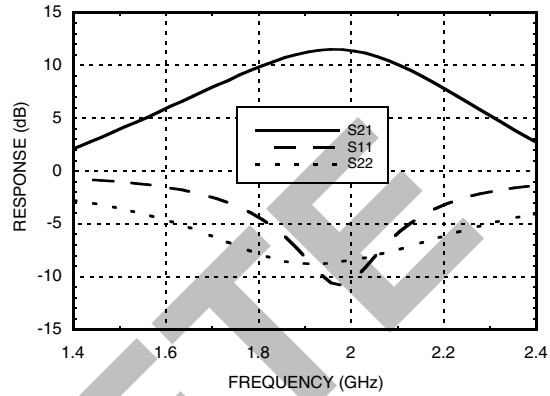

**Gain vs. Temperature @ 400 mA**

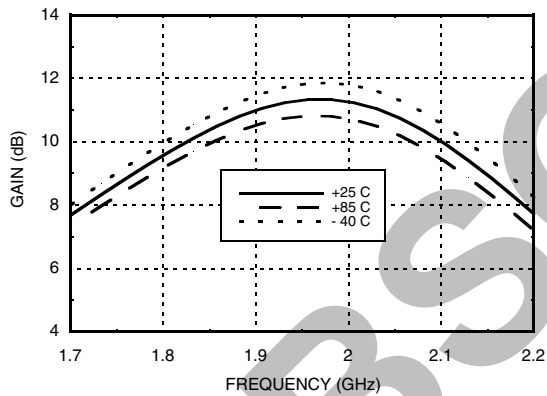

**Gain vs. Temperature @ 700 mA**

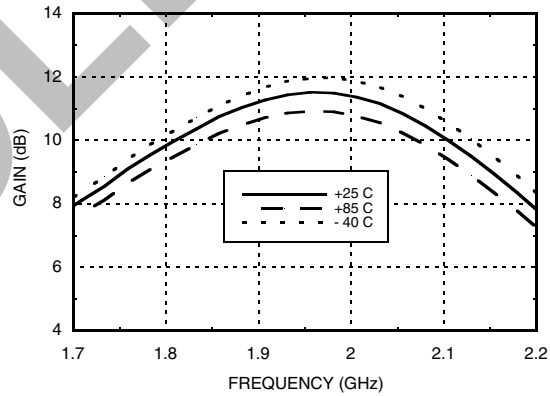

**Input Return Loss @ 400 mA**

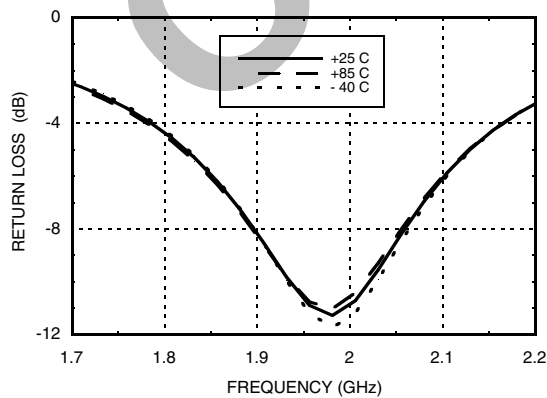

**Input Return Loss @ 700 mA**

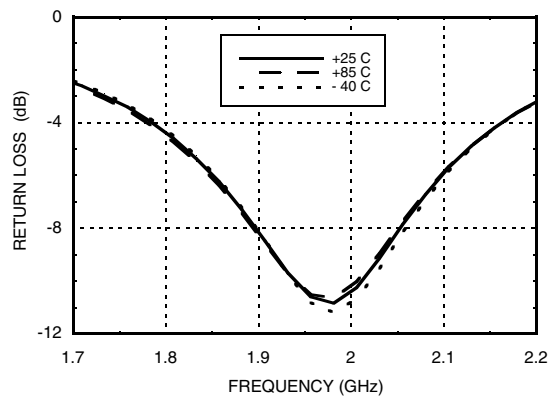

Information furnished by Analog Devices is believed to be accurate and reliable. However, no responsibility is assumed by Analog Devices for its use, nor for any infringements of patents or other rights of third parties that may result from its use. Specifications subject to change without notice. No license is granted by implication or otherwise under any patent or patent rights of Analog Devices. Trademarks and registered trademarks are the property of their respective owners.

For price, delivery, and to place orders: Analog Devices, Inc., One Technology Way, P.O. Box 9106, Norwood, MA 02062-9106 Phone: 781-329-4700 • Order online at [www.analog.com](http://www.analog.com) Application Support: Phone: 1-800-ANALOG-D



**GaAs HBT MMIC 2 WATT  
POWER AMPLIFIER, 0.4 - 2.7 GHz  
1900 MHz Tune**

**Output Return Loss @ 400 mA**

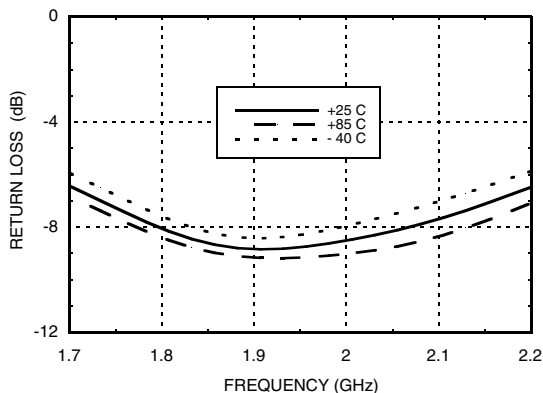

**Output Return Loss @ 700 mA**

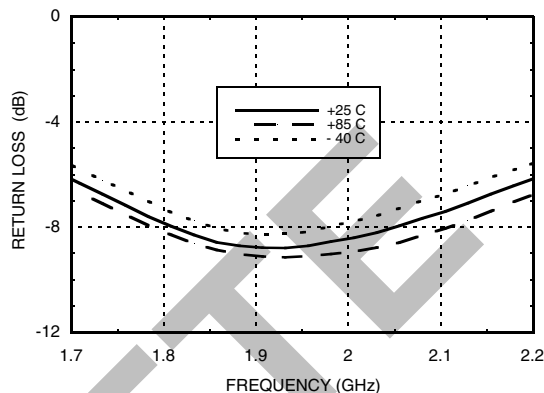

**P1dB vs. Temperature @ 400 mA**

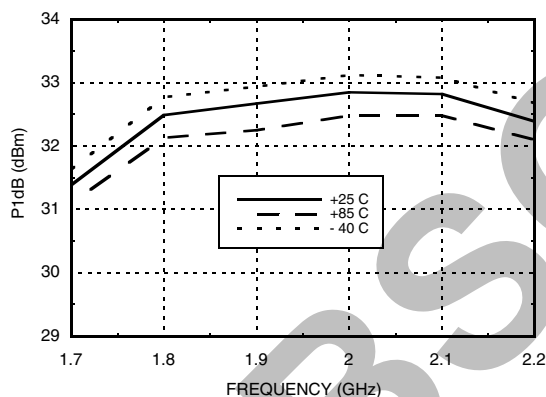

**P1dB vs. Temperature @ 700 mA**

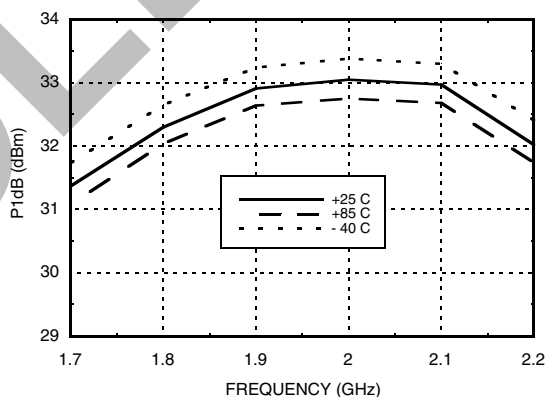

**Psat vs. Temperature @ 400 mA**

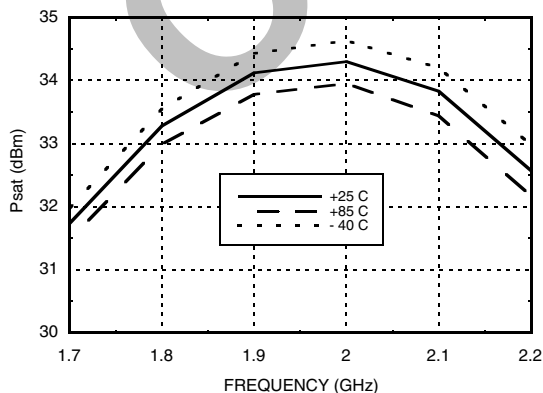

**Psat vs. Temperature @ 700 mA**

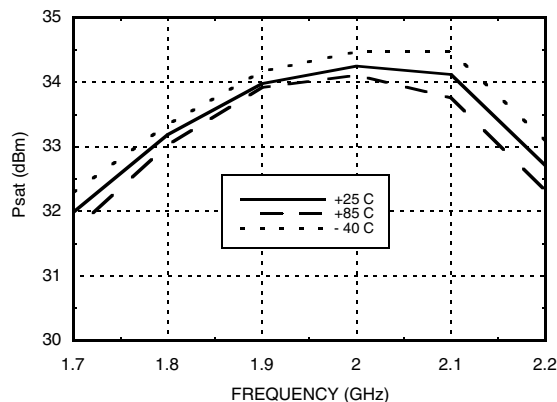

Information furnished by Analog Devices is believed to be accurate and reliable. However, no responsibility is assumed by Analog Devices for its use, nor for any infringements of patents or other rights of third parties that may result from its use. Specifications subject to change without notice. No license is granted by implication or otherwise under any patent or patent rights of Analog Devices. Trademarks and registered trademarks are the property of their respective owners.

For price, delivery, and to place orders: Analog Devices, Inc., One Technology Way, P.O. Box 9106, Norwood, MA 02062-9106 Phone: 781-329-4700 • Order online at [www.analog.com](http://www.analog.com) Application Support: Phone: 1-800-ANALOG-D



**GaAs HBT MMIC 2 WATT  
POWER AMPLIFIER, 0.4 - 2.7 GHz  
1900 MHz Tune**

**Output IP3 vs. Output Power @ 400 mA**

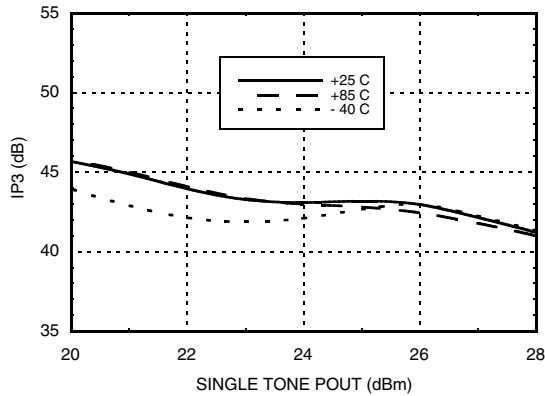

**Output IP3 vs. Output Power @ 700 mA**

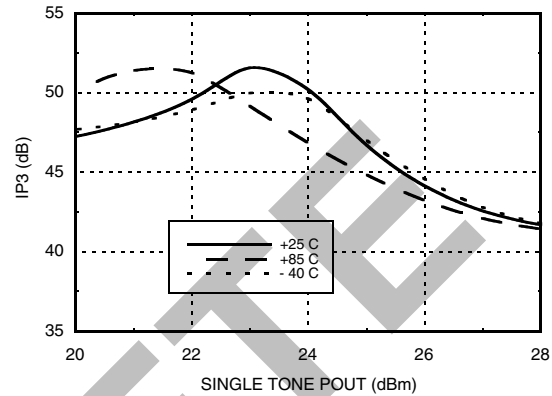

**Noise Figure vs. Temperature @ 400 mA**

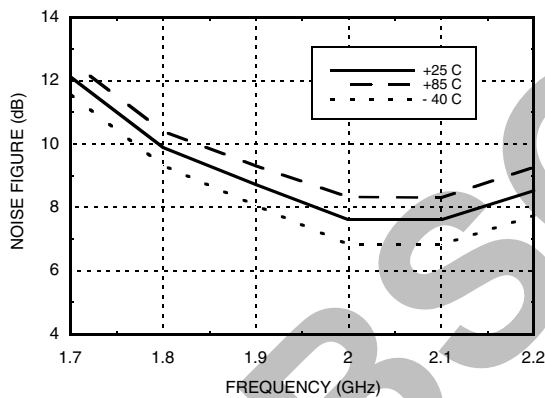

**Noise Figure vs. Temperature @ 700 mA**

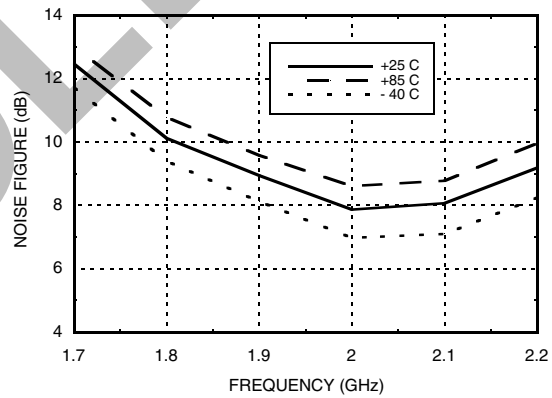

**Reverse Isolation vs. Temperature 400 mA**

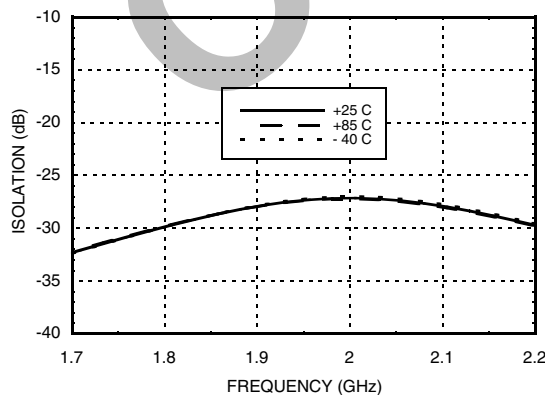

**Reverse Isolation vs. Temperature 700 mA**

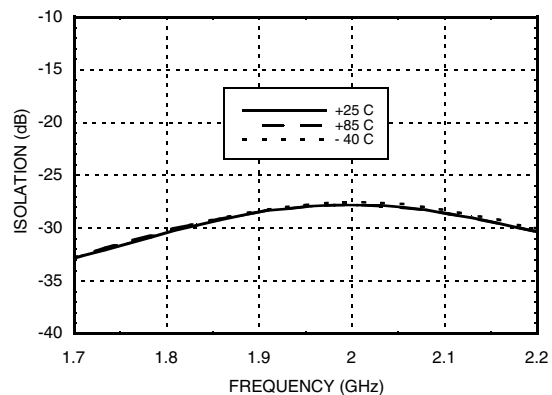

Information furnished by Analog Devices is believed to be accurate and reliable. However, no responsibility is assumed by Analog Devices for its use, nor for any infringements of patents or other rights of third parties that may result from its use. Specifications subject to change without notice. No license is granted by implication or otherwise under any patent or patent rights of Analog Devices. Trademarks and registered trademarks are the property of their respective owners.

For price, delivery, and to place orders: Analog Devices, Inc., One Technology Way, P.O. Box 9106, Norwood, MA 02062-9106 Phone: 781-329-4700 • Order online at [www.analog.com](http://www.analog.com) Application Support: Phone: 1-800-ANALOG-D



**GaAs HBT MMIC 2 WATT  
POWER AMPLIFIER, 0.4 - 2.7 GHz  
1900 MHz Tune**

AMPLIFIERS - LINEAR & POWER - SMT

**Power Compression @ 400 mA**

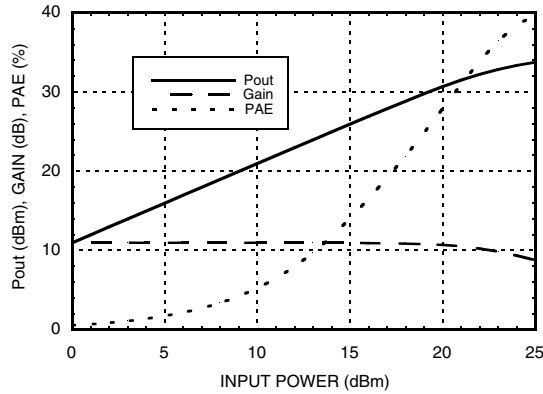

**Power Compression @ 700 mA**

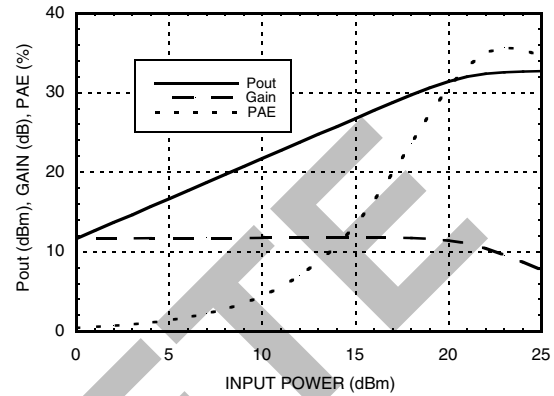

**ACPR vs. Temperature @ 1960 MHz  
CDMA 2000, 9 Channels Forward, 400 mA**

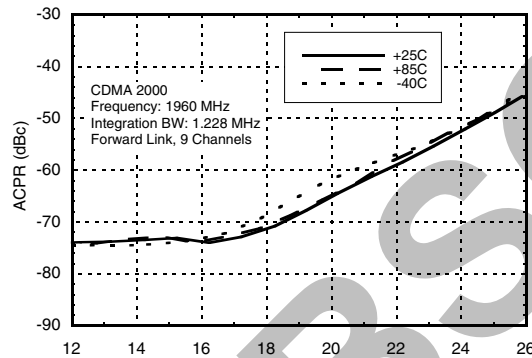

**ACPR vs. Temperature @ 1960 MHz  
CDMA 2000, 9 Channels Forward, 700 mA**

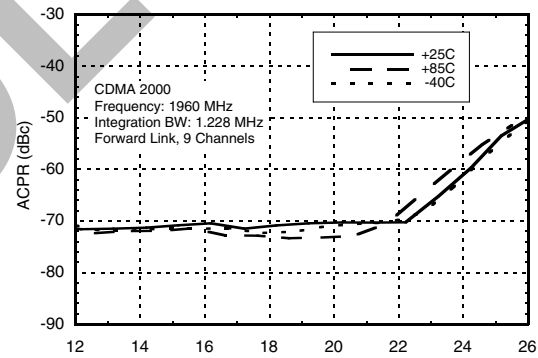

**Output IP3 vs. Bias Current**

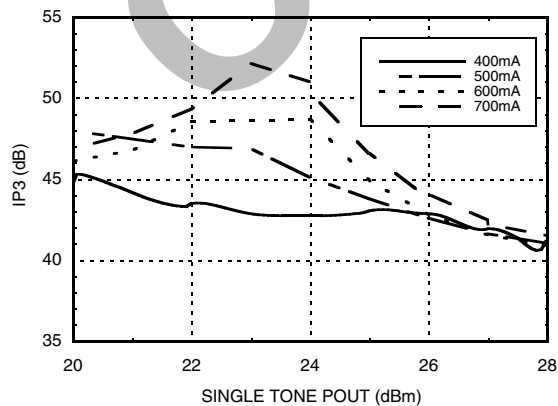

**VDET Output Voltage vs. Temperature**

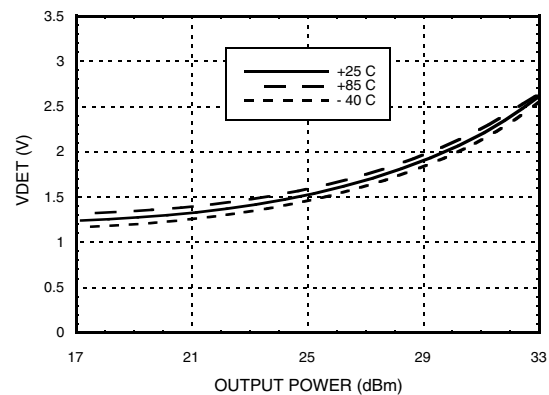

Information furnished by Analog Devices is believed to be accurate and reliable. However, no responsibility is assumed by Analog Devices for its use, nor for any infringements of patents or other rights of third parties that may result from its use. Specifications subject to change without notice. No license is granted by implication or otherwise under any patent or patent rights of Analog Devices. Trademarks and registered trademarks are the property of their respective owners.

For price, delivery, and to place orders: Analog Devices, Inc., One Technology Way, P.O. Box 9106, Norwood, MA 02062-9106 Phone: 781-329-4700 • Order online at [www.analog.com](http://www.analog.com) Application Support: Phone: 1-800-ANALOG-D



**GaAs HBT MMIC 2 WATT  
POWER AMPLIFIER, 0.4 - 2.7 GHz  
2150 MHz Tune**

**Broadband Gain & Return Loss @ 400 mA**

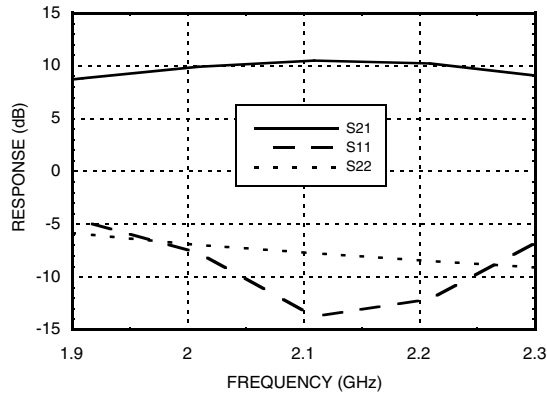

**Broadband Gain & Return Loss @ 700 mA**

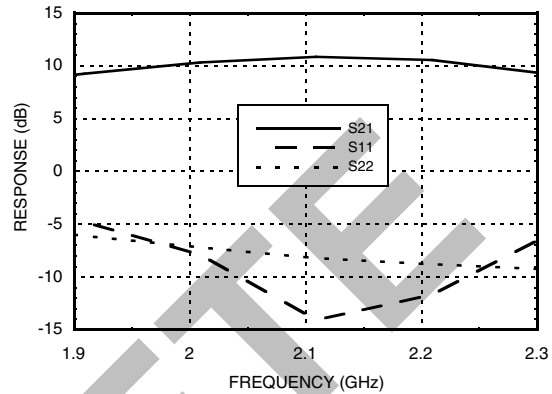

**Gain vs. Temperature @ 400 mA**

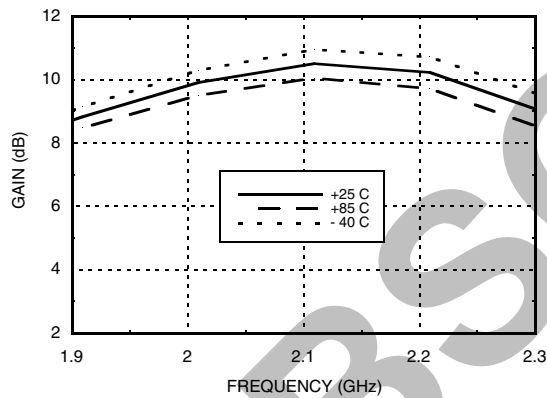

**Gain vs. Temperature @ 700 mA**

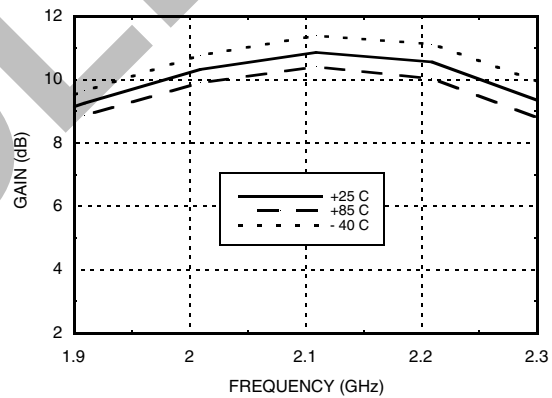

**Input Return Loss @ 400 mA**

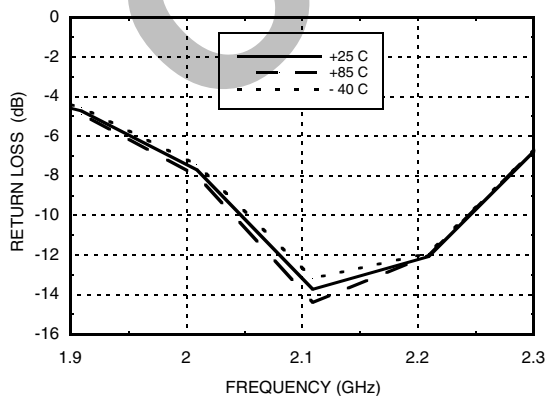

**Input Return Loss @ 700 mA**

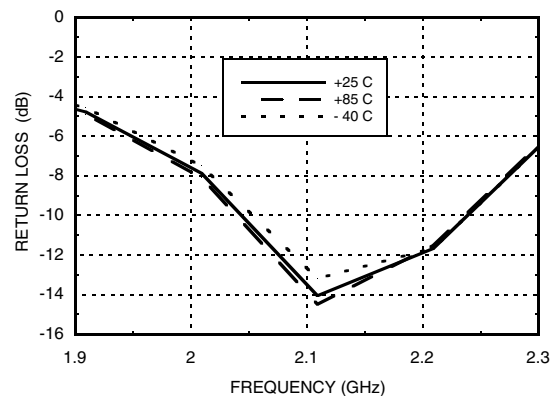

Information furnished by Analog Devices is believed to be accurate and reliable. However, no responsibility is assumed by Analog Devices for its use, nor for any infringements of patents or other rights of third parties that may result from its use. Specifications subject to change without notice. No license is granted by implication or otherwise under any patent or patent rights of Analog Devices. Trademarks and registered trademarks are the property of their respective owners.

For price, delivery, and to place orders: Analog Devices, Inc., One Technology Way, P.O. Box 9106, Norwood, MA 02062-9106 Phone: 781-329-4700 • Order online at [www.analog.com](http://www.analog.com) Application Support: Phone: 1-800-ANALOG-D



**GaAs HBT MMIC 2 WATT  
POWER AMPLIFIER, 0.4 - 2.7 GHz  
2150 MHz Tune**

**Output Return Loss @ 400 mA**

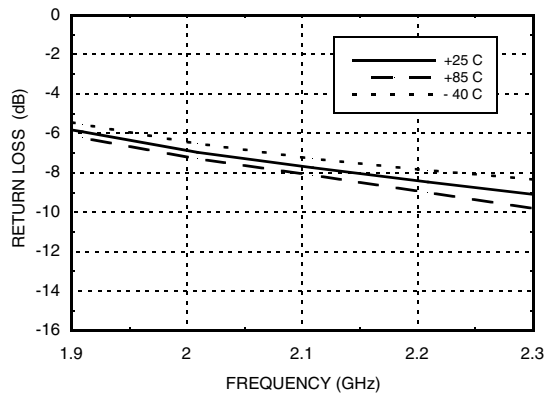

**Output Return Loss @ 700 mA**

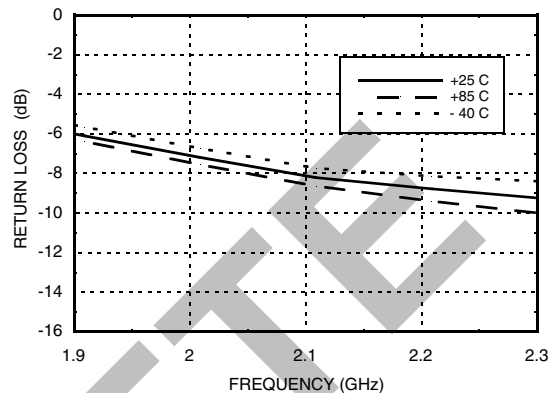

**P1dB vs. Temperature @ 400 mA**

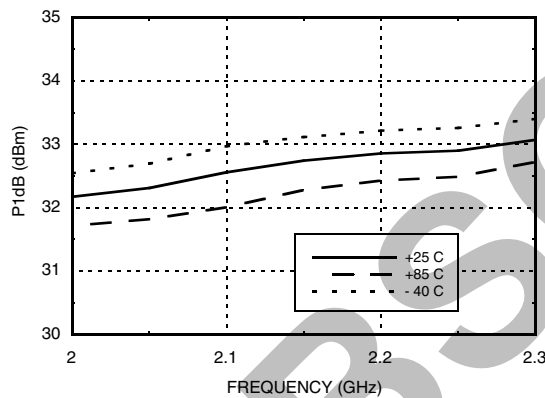

**P1dB vs. Temperature @ 700 mA**

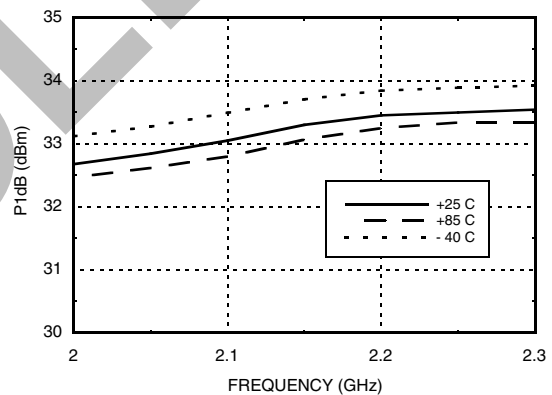

**Psat vs. Temperature @ 400 mA**

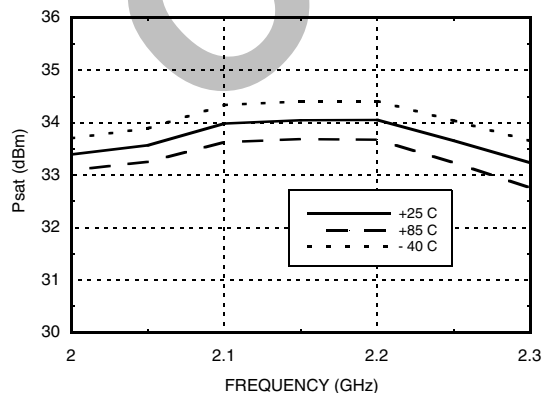

**Psat vs. Temperature @ 700 mA**

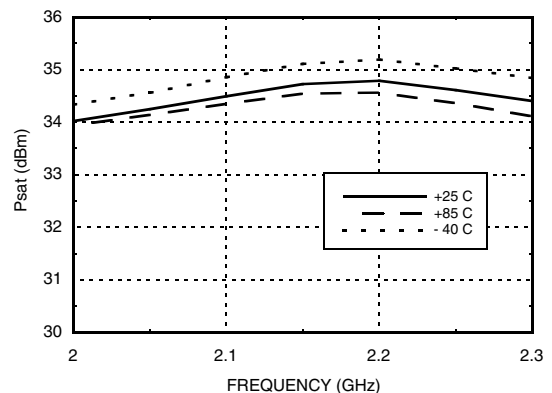

Information furnished by Analog Devices is believed to be accurate and reliable. However, no responsibility is assumed by Analog Devices for its use, nor for any infringements of patents or other rights of third parties that may result from its use. Specifications subject to change without notice. No license is granted by implication or otherwise under any patent or patent rights of Analog Devices. Trademarks and registered trademarks are the property of their respective owners.

For price, delivery, and to place orders: Analog Devices, Inc., One Technology Way, P.O. Box 9106, Norwood, MA 02062-9106 Phone: 781-329-4700 • Order online at [www.analog.com](http://www.analog.com) Application Support: Phone: 1-800-ANALOG-D



**GaAs HBT MMIC 2 WATT  
POWER AMPLIFIER, 0.4 - 2.7 GHz  
2150 MHz Tune**

**Output IP3 vs Output Power @ 400 mA**

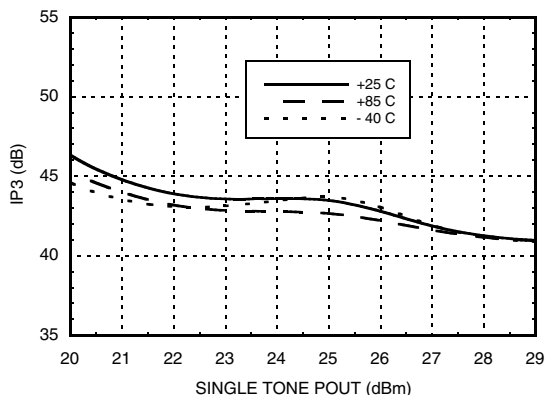

**Output IP3 vs Output Power @ 700 mA**

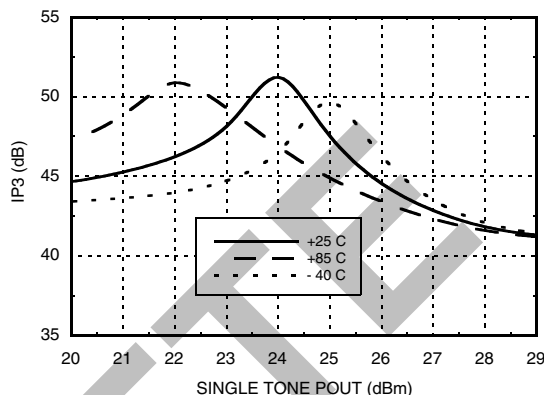

**Noise Figure vs. Temperature @ 400 mA**

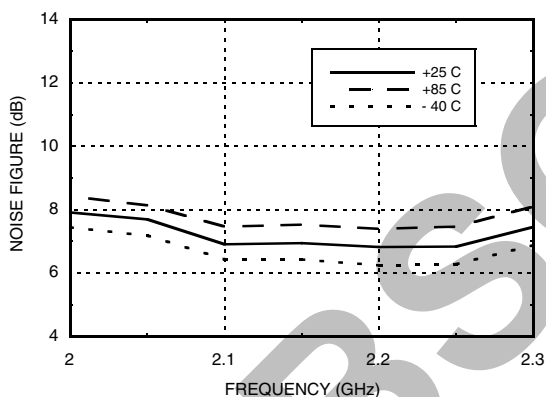

**Noise Figure vs. Temperature @ 700 mA**

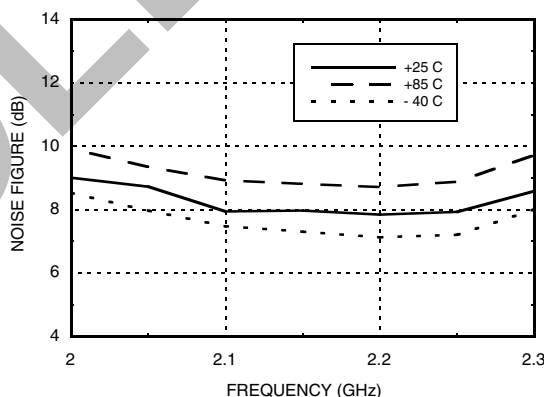

**Reverse Isolation vs. Temperature 400 mA**

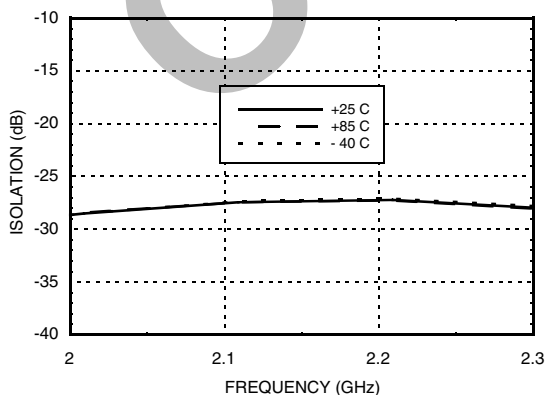

**Reverse Isolation vs. Temperature 700 mA**

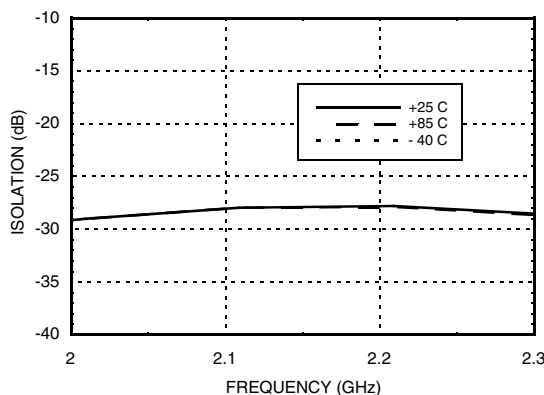

Information furnished by Analog Devices is believed to be accurate and reliable. However, no responsibility is assumed by Analog Devices for its use, nor for any infringements of patents or other rights of third parties that may result from its use. Specifications subject to change without notice. No license is granted by implication or otherwise under any patent or patent rights of Analog Devices. Trademarks and registered trademarks are the property of their respective owners.

For price, delivery, and to place orders: Analog Devices, Inc., One Technology Way, P.O. Box 9106, Norwood, MA 02062-9106 Phone: 781-329-4700 • Order online at [www.analog.com](http://www.analog.com) Application Support: Phone: 1-800-ANALOG-D





**GaAs HBT MMIC 2 WATT  
POWER AMPLIFIER, 0.4 - 2.7 GHz  
2150 MHz Tune**

**Power Compression @ 400 mA**

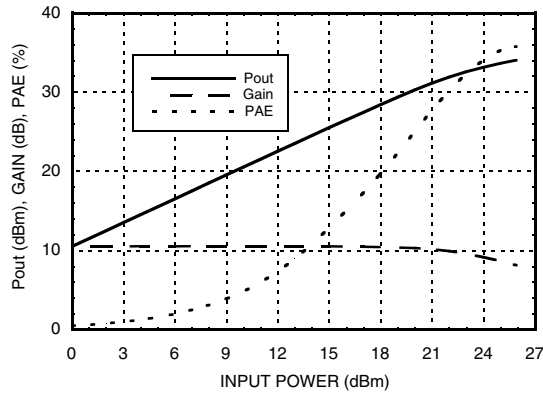

**Power Compression @ 700 mA**

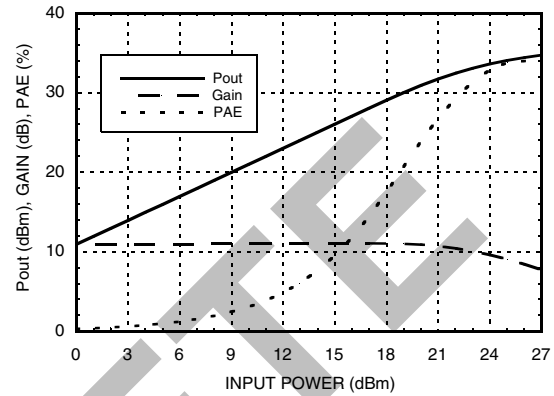

OBSOLETE



**GaAs HBT MMIC 2 WATT  
POWER AMPLIFIER, 0.4 - 2.7 GHz  
2700 MHz Tune**

**Broadband Gain & Return Loss @ 400 mA**

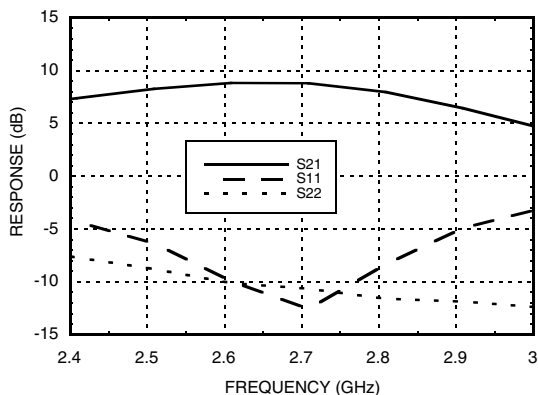

**Broadband Gain & Return Loss @ 700 mA**

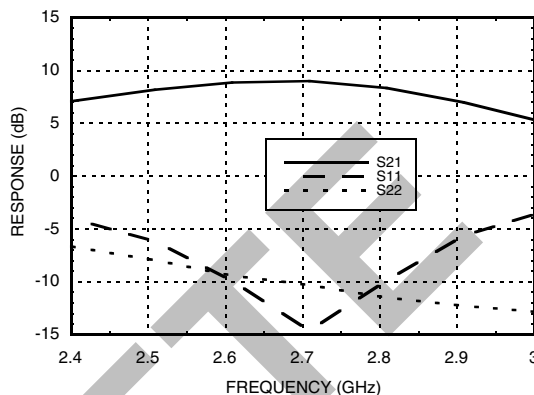

**Gain vs. Temperature @ 400 mA**

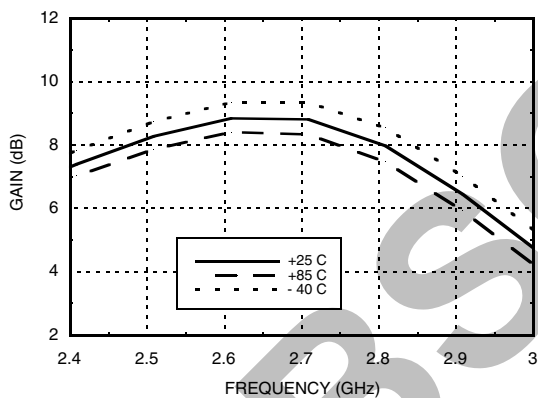

**Gain vs. Temperature @ 700 mA**

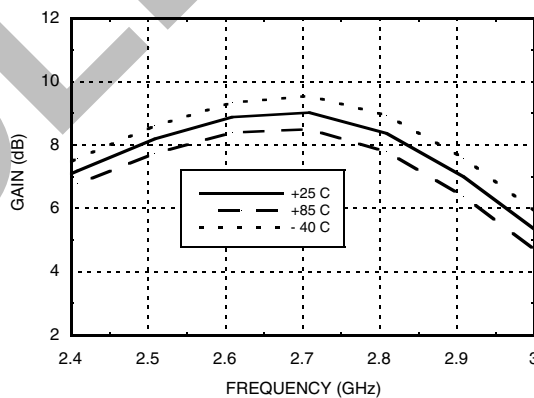

**Input Return Loss @ 400 mA**

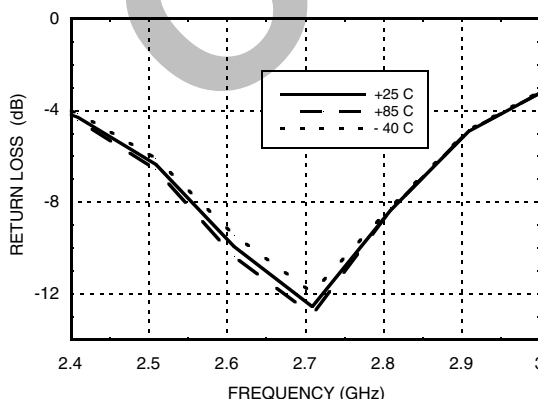

**Input Return Loss @ 700 mA**

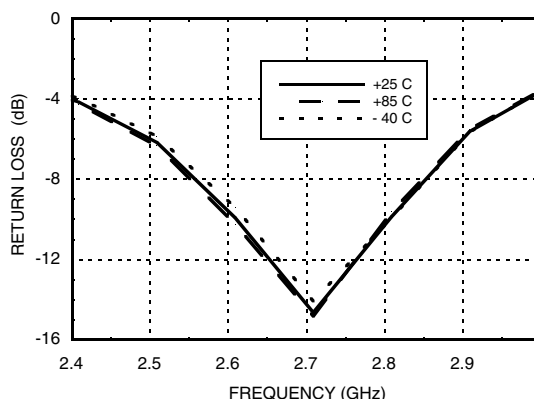

Information furnished by Analog Devices is believed to be accurate and reliable. However, no responsibility is assumed by Analog Devices for its use, nor for any infringements of patents or other rights of third parties that may result from its use. Specifications subject to change without notice. No license is granted by implication or otherwise under any patent or patent rights of Analog Devices. Trademarks and registered trademarks are the property of their respective owners.

For price, delivery, and to place orders: Analog Devices, Inc., One Technology Way, P.O. Box 9106, Norwood, MA 02062-9106 Phone: 781-329-4700 • Order online at [www.analog.com](http://www.analog.com) Application Support: Phone: 1-800-ANALOG-D



**GaAs HBT MMIC 2 WATT  
POWER AMPLIFIER, 0.4 - 2.7 GHz  
2700 MHz Tune**

AMPLIFIERS - LINEAR & POWER - SMT

**Output Return Loss @ 400 mA**

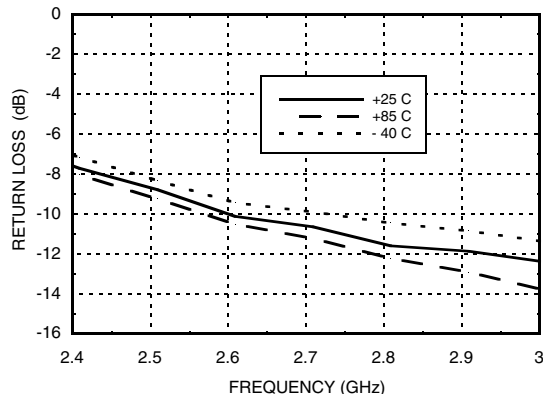

**Output Return Loss @ 700 mA**

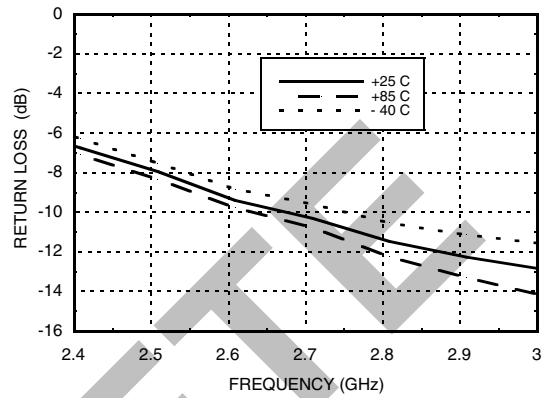

**P1dB vs. Temperature @ 400 mA**

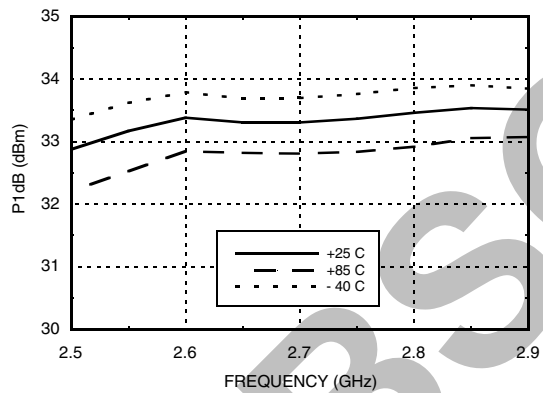

**P1dB vs. Temperature @ 700 mA**

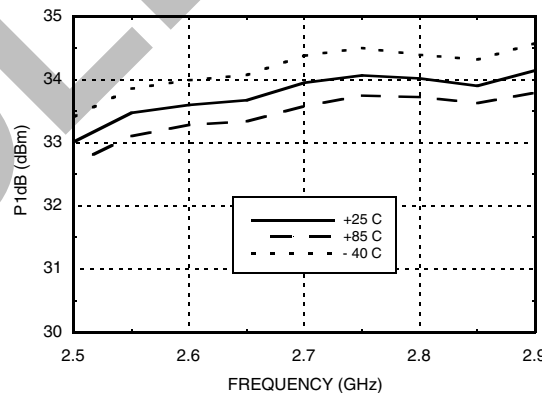

**Psat vs. Temperature @ 400 mA**

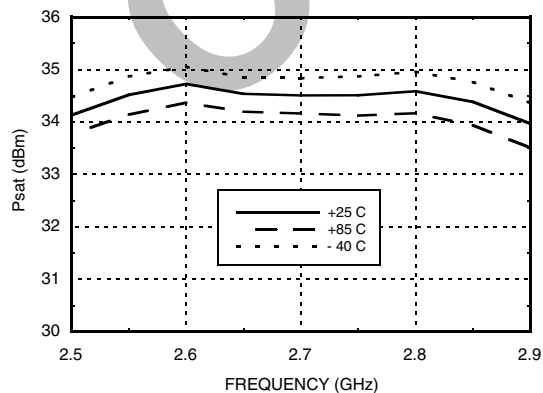

**Psat vs. Temperature @ 700 mA**

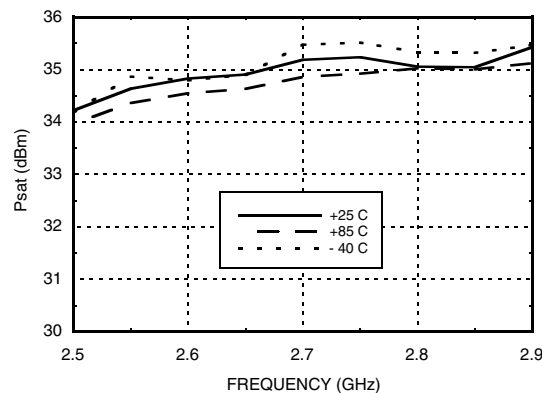

Information furnished by Analog Devices is believed to be accurate and reliable. However, no responsibility is assumed by Analog Devices for its use, nor for any infringements of patents or other rights of third parties that may result from its use. Specifications subject to change without notice. No license is granted by implication or otherwise under any patent or patent rights of Analog Devices. Trademarks and registered trademarks are the property of their respective owners.

For price, delivery, and to place orders: Analog Devices, Inc., One Technology Way, P.O. Box 9106, Norwood, MA 02062-9106 Phone: 781-329-4700 • Order online at [www.analog.com](http://www.analog.com) Application Support: Phone: 1-800-ANALOG-D



**GaAs HBT MMIC 2 WATT  
POWER AMPLIFIER, 0.4 - 2.7 GHz  
2700 MHz Tune**

**Output IP3 vs. Output Power @ 400 mA**

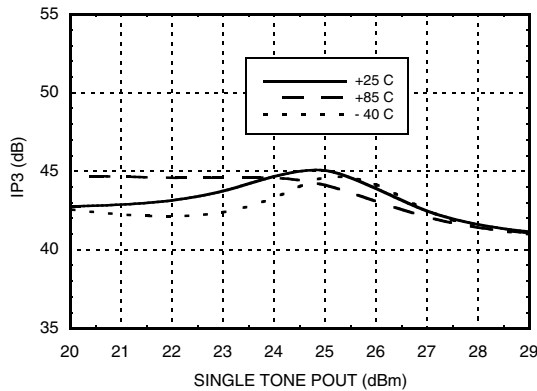

**Output IP3 vs. Output Power @ 700 mA**

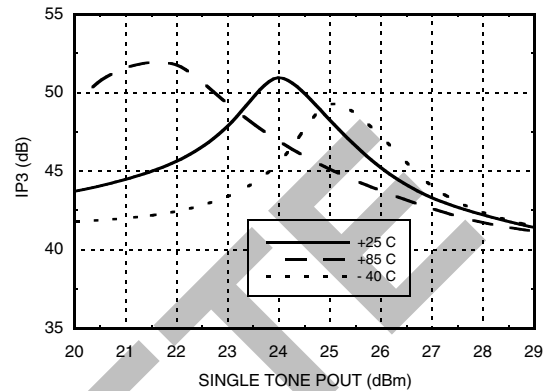

**Noise Figure vs. Temperature @ 400 mA**

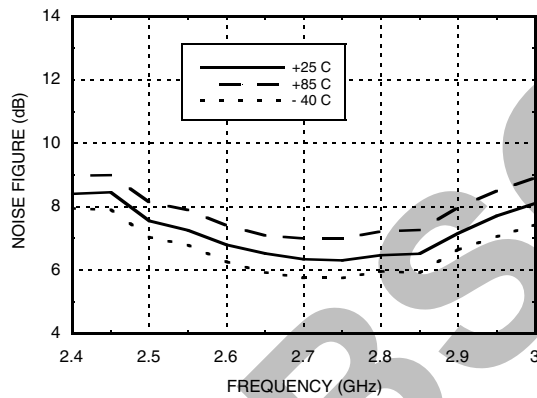

**Noise Figure vs. Temperature @ 700 mA**

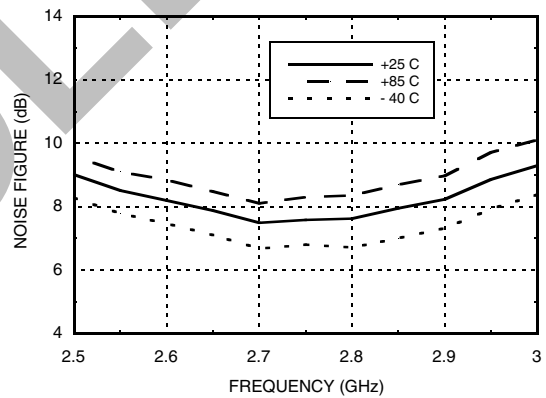

**Reverse Isolation vs. Temperature 400 mA**

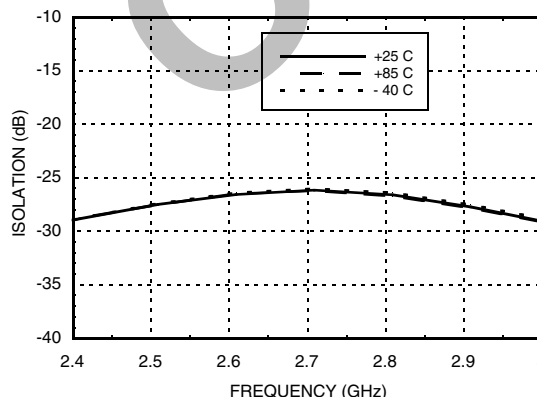

**Reverse Isolation vs. Temperature 700 mA**

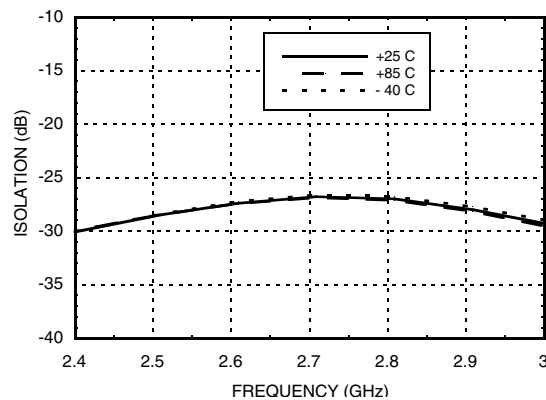

Information furnished by Analog Devices is believed to be accurate and reliable. However, no responsibility is assumed by Analog Devices for its use, nor for any infringements of patents or other rights of third parties that may result from its use. Specifications subject to change without notice. No license is granted by implication or otherwise under any patent or patent rights of Analog Devices. Trademarks and registered trademarks are the property of their respective owners.

For price, delivery, and to place orders: Analog Devices, Inc., One Technology Way, P.O. Box 9106, Norwood, MA 02062-9106 Phone: 781-329-4700 • Order online at [www.analog.com](http://www.analog.com) Application Support: Phone: 1-800-ANALOG-D



**GaAs HBT MMIC 2 WATT  
POWER AMPLIFIER, 0.4 - 2.7 GHz  
2700 MHz Tune**

**Output IP3 vs. Output Power @ 400 mA**

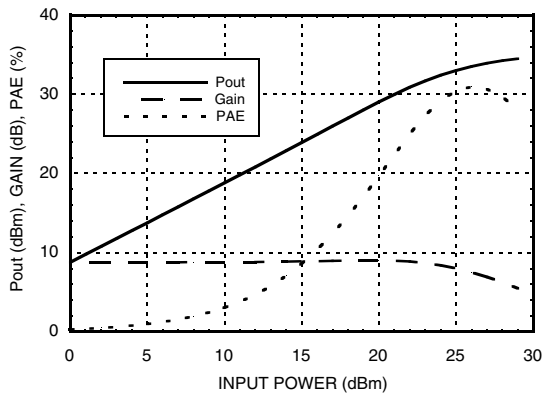

**Output IP3 vs. Output Power @ 700 mA**

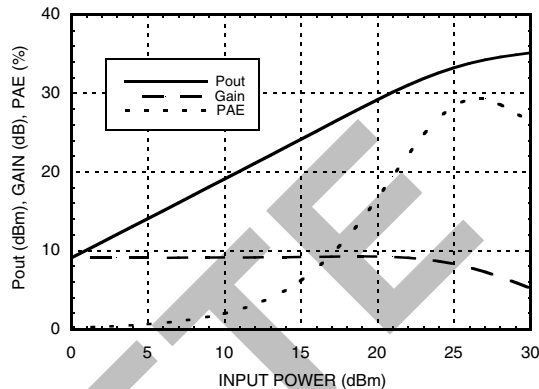

OBSOLETE



## GaAs HBT MMIC 2 WATT POWER AMPLIFIER, 0.4 - 2.7 GHz

**Icc1 + IEN vs. Output Power @ 400 mA**

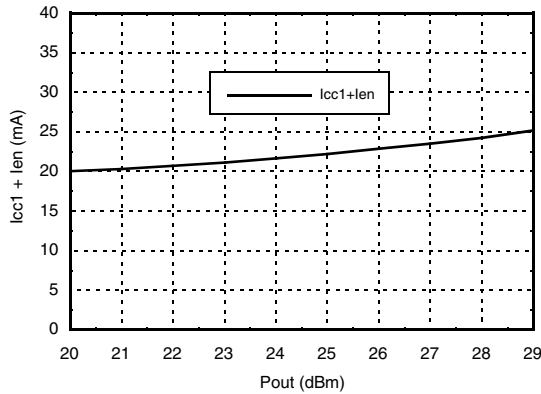

**Icc1 + IEN vs. Output Power @ 700 mA**

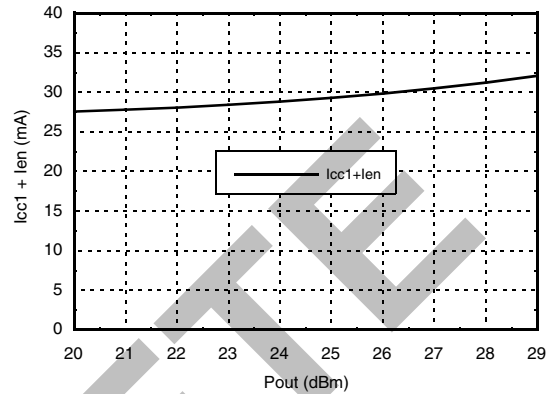

**Icc2 vs. Output Power @ 400 mA**

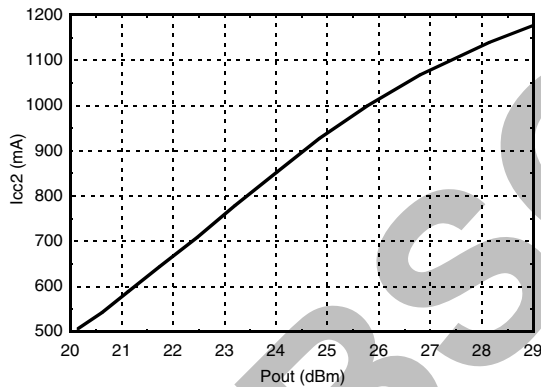

**Icc2 vs. Output Power @ 700 mA**

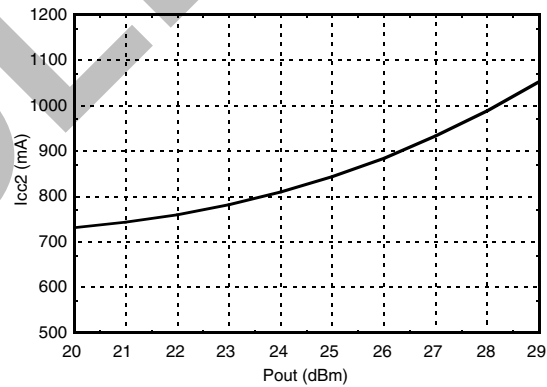

### Absolute Maximum Ratings

|   |   |
|---|---|
| Collector Bias Voltage (Vcc1, Vcc2)   | +5.5V                                   |
| RF Input Power (RFIN)   | +21 dBm @ 900 MHz<br>+26 dBm @ 1900 MHz |
| Junction Temperature  | 150 °C                                  |
| Continuous P <sub>diss</sub> (T = 85 °C)<br>(derate 67.9 mW/°C above 85 °C) | 4.4 W                                   |
| Thermal Resistance<br>(junction to ground paddle)                           | 14.72 °C/W                              |
| Storage Temperature   | -65 to +150 °C                          |
| Operating Temperature   | -40 to +85 °C                           |
| ESD Sensitivity (HBM)   | Class 1C                                |

### Recommended Bias Resistor Value

#### Bias Current vs. R1, Ven = 5V

| Vcc1 = Vcc2 (V) | R1 (Ohms) | IEN + Icc1 + Icc2 (mA) |
|-----------------|-----------|------------------------|
| 5V              | 270       | 420                    |
|                 | 225       | 522                    |
|                 | 175       | 625                    |
|                 | 130       | 715                    |

#### Bias Current vs. R1, Ven = 0V

| Vcc1 = Vcc2 (V) | R1 (Ohms) | IEN + Icc1 + Icc2 (mA) |
|-----------------|-----------|------------------------|
| 5V              | 270       | 2.6                    |
|                 | 225       | 2.6                    |
|                 | 175       | 2.6                    |
|                 | 130       | 2.6                    |



**ELECTROSTATIC SENSITIVE DEVICE  
OBSERVE HANDLING PRECAUTIONS**



**GaAs HBT MMIC 2 WATT POWER AMPLIFIER, 0.4 - 2.7 GHz**

**Outline Drawing**

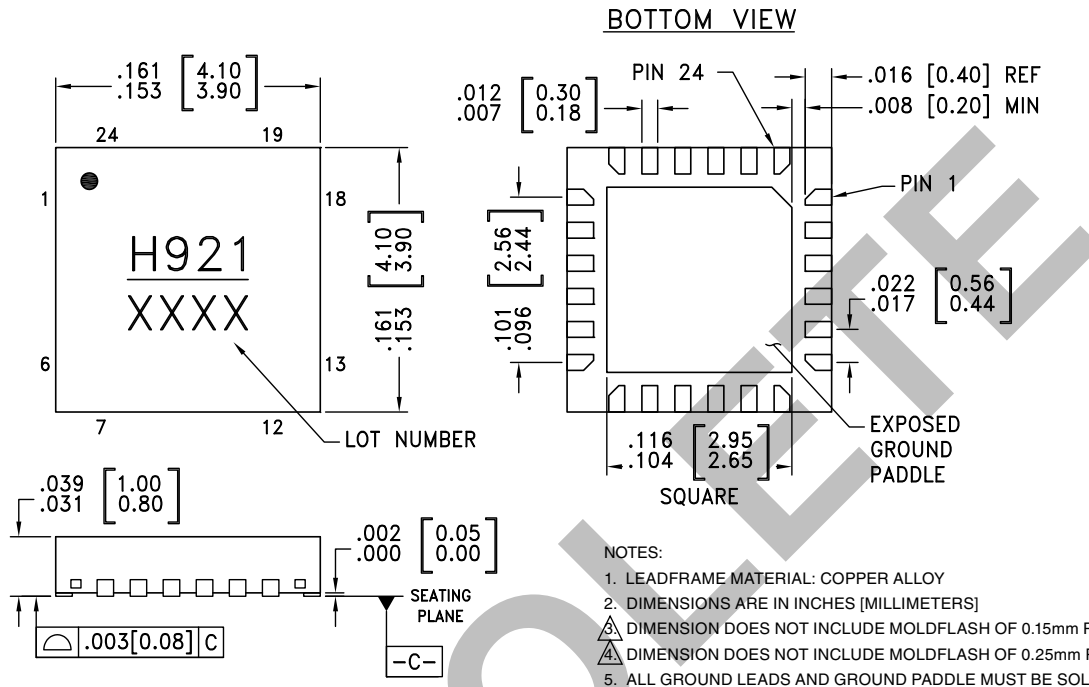

- NOTES:**
1. LEADFRAME MATERIAL: COPPER ALLOY
  2. DIMENSIONS ARE IN INCHES (MILLIMETERS)
  3. DIMENSION DOES NOT INCLUDE MOLDFLASH OF 0.15mm PER SIDE.
  4. DIMENSION DOES NOT INCLUDE MOLDFLASH OF 0.25mm PER SIDE.
  5. ALL GROUND LEADS AND GROUND PADDLE MUST BE SOLDERED TO PCB RF GROUND.

**Package Information**

| Part Number | Package Body Material                              | Lead Finish   | MSL Rating          | Package Marking <sup>[1]</sup> |
|-------------|--|---------------|---------------------|--------------------------------|
| HMC921LP4E  | RoHS-compliant Low Stress Injection Molded Plastic | 100% matte Sn | MSL1 <sup>[2]</sup> | H921<br>XXXX                   |

[1] 4-Digit lot number XXXX  
 [2] Max peak reflow temperature of 260 °C

**Pin Descriptions**

| Pin Number                                 | Function     | Description  | Interface Schematic |
|--|--------------|--|---------------------|
| 1 - 3, 6 - 10, 12 - 14, 18, 19, 21, 22, 24 | N/C          | The pins are not connected internally; however, all data shown herein was measured with these pins connected to RF/DC ground externally.     |                     |
| 4  | RFIN         | This pin is DC coupled. Off chip matching components are required. See Application Circuit herein.   |                     |
| 15 - 17                                    | RFOUT / Vcc2 | RF output and DC Bias input for the amplifier. Off chip matching components are required. See Application Circuit herein.                    |                     |
| 5  | GND          | These pins & package bottom must be connected to RF/DC ground.   |                     |
| 11   | VDET         | DC voltage output proportional to RFOUT signal.  |                     |
| 20   | VEN          | Power control pin. This voltage can be reduced or R1 resistor value increased to reduce quiescent current. For full power down, apply < 0.5V |                     |
| 23   | Vcc1         | DC power supply pin for bias circuitry   |                     |

Information furnished by Analog Devices is believed to be accurate and reliable. However, no responsibility is assumed by Analog Devices for its use, nor for any infringements of patents or other rights of third parties that may result from its use. Specifications subject to change without notice. No license is granted by implication or otherwise under any patent or patent rights of Analog Devices. Trademarks and registered trademarks are the property of their respective owners.

For price, delivery, and to place orders: Analog Devices, Inc., One Technology Way, P.O. Box 9106, Norwood, MA 02062-9106 Phone: 781-329-4700 • Order online at [www.analog.com](http://www.analog.com) Application Support: Phone: 1-800-ANALOG-D



## GaAs HBT MMIC 2 WATT POWER AMPLIFIER, 0.4 - 2.7 GHz

### 450 MHz Evaluation PCB

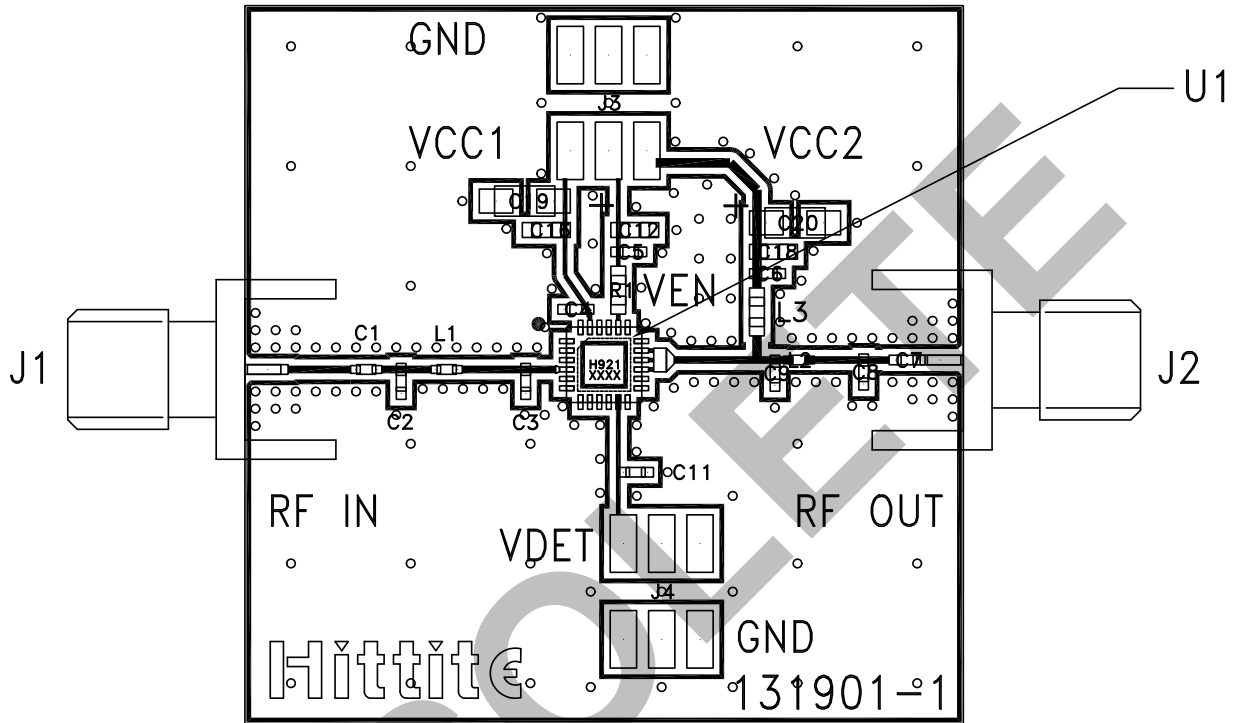

### List of Materials for 450 MHz Evaluation PCB 131903 [1]

| Item          | Description                  |
|---------------|------------------------------|
| J1, J2        | SMA Connector                |
| J3, J4        | DC Pin                       |
| C1, C9        | 30 pF Capacitor, 0402 Pkg.   |
| C2            | 15 pF Capacitor, 0402 Pkg.   |
| C3            | 27 pF Capacitor, 0402 Pkg.   |
| C4 - C6, C11  | 100 pF Capacitor, 0402 Pkg.  |
| C9, C20       | 2.2 uF Capacitor, Case A     |
| C12, C16, C18 | 1000 pF Capacitor, 0402 Pkg. |
| R1            | 130 ohms Resistor, 0603 Pkg. |
| L1            | 3.6 nH Inductor, 0402 Pkg.   |
| L2            | 4.7 nH Inductor, 0402 Pkg.   |
| L3            | 150 nH Inductor, 0603 Pkg.   |
| U1            | HMC921LP4E Amplifier         |
| PCB [2]       | 131901 Evaluation PCB        |

[1] Reference this number when ordering complete evaluation PCB

[2] Circuit Board Material: Rogers 4350 or Arlon 25 FR

The circuit board used in this application should use RF circuit design techniques. Signal lines should have 50 Ohm impedance while the package ground leads and exposed paddle should be connected directly to the ground plane similar to that shown. A sufficient number of via holes should be used to connect the top and bottom ground planes. The evaluation board should be mounted to an appropriate heat sink. The evaluation circuit board shown is available from Hittite upon request.





**GaAs HBT MMIC 2 WATT  
POWER AMPLIFIER, 0.4 - 2.7 GHz**

**450 MHz Application Circuit**

This circuit was used to specify the performance for 350 - 500 MHz operation. Contact the HMC Applications Group for assistance in optimizing performance for your application.

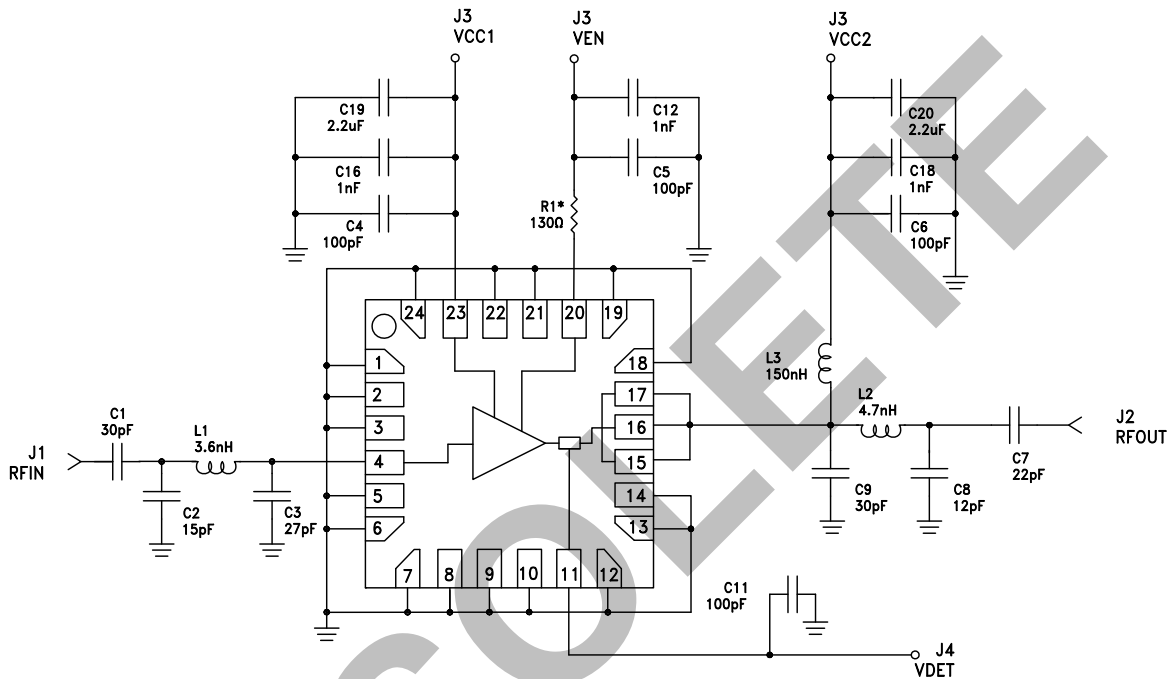

\* R1 = 130 Ohms for 700 mA bias, 270 Ohms for 400 mA bias.

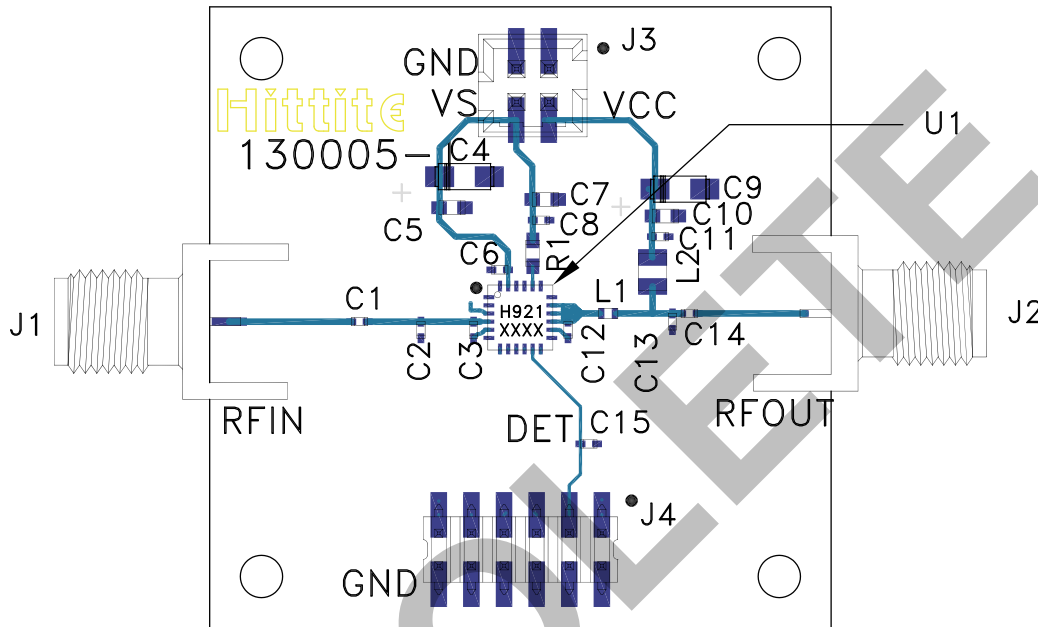
**GaAs HBT MMIC 2 WATT  
POWER AMPLIFIER, 0.4 - 2.7 GHz**
**900 MHz Evaluation PCB**

**List of Materials for 900 MHz Evaluation PCB 130007 [1]**

| Item                  | Description                     |
|-----------------------|---------------------------------|
| J1 - J2               | PCB Mount SMA Connector         |
| J3 - J4               | 2 mm DC Header                  |
| C1                    | 22 pF Capacitor, 0402 Pkg.      |
| C2                    | 7.5 pF Capacitor, 0402 Pkg.     |
| C3                    | 5.6 pF Capacitor, 0402 Pkg.     |
| C4, C9                | 2.2 $\mu$ F Capacitor, Tantalum |
| C5, C7, C10           | 1000 pF Capacitor, 0603 Pkg.    |
| C6, C8, C11, C14, C15 | 100 pF Capacitor, 0402 Pkg.     |
| C12, C13              | 8.2 pF Capacitor, 0402 Pkg.     |
| L1                    | 0.78 nH Inductor, 0402 Pkg.     |
| L2                    | 48 nH Inductor, 0402 Pkg.       |
| R1                    | 130 Ohms Resistor, 0603 Pkg.    |
| U1                    | HMC921LP4E Linear Amplifier     |
| PCB [2]               | 130005 Evaluation PCB           |

[1] Reference this number when ordering complete evaluation PCB

[2] Circuit Board Material: Rogers 4350 or Arlon 25 FR

The circuit board used in this application should use RF circuit design techniques. Signal lines should have 50 Ohm impedance while the package ground leads and exposed paddle should be connected directly to the ground plane similar to that shown. A sufficient number of via holes should be used to connect the top and bottom ground planes. The evaluation board should be mounted to an appropriate heat sink. The evaluation circuit board shown is available from Hittite upon request.



**GaAs HBT MMIC 2 WATT  
POWER AMPLIFIER, 0.4 - 2.7 GHz**

**900 MHz Application Circuit**

This circuit was used to specify the performance for 800 - 1000 MHz operation. Contact the HMC Applications Group for assistance in optimizing performance for your application.

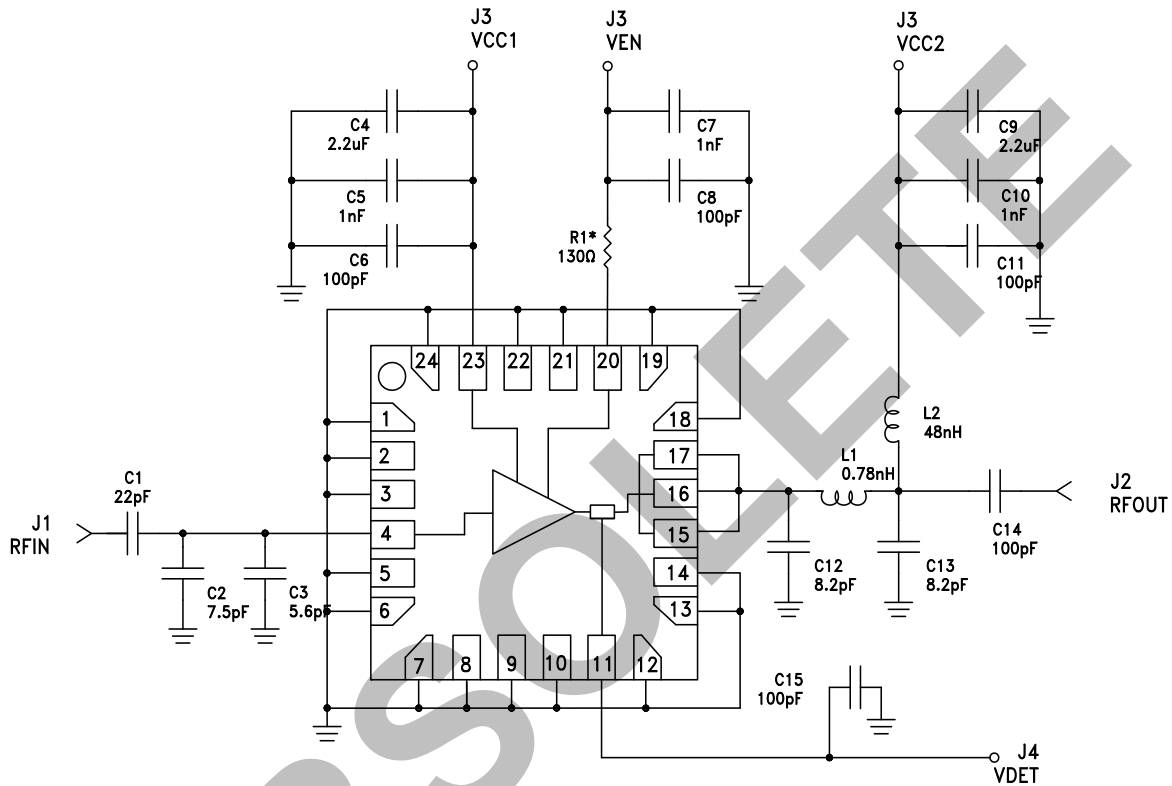

\* R1 = 130 Ohms for 700 mA bias, 270 Ohms for 400 mA bias.



## GaAs HBT MMIC 2 WATT POWER AMPLIFIER, 0.4 - 2.7 GHz

### 1900 MHz Evaluation PCB

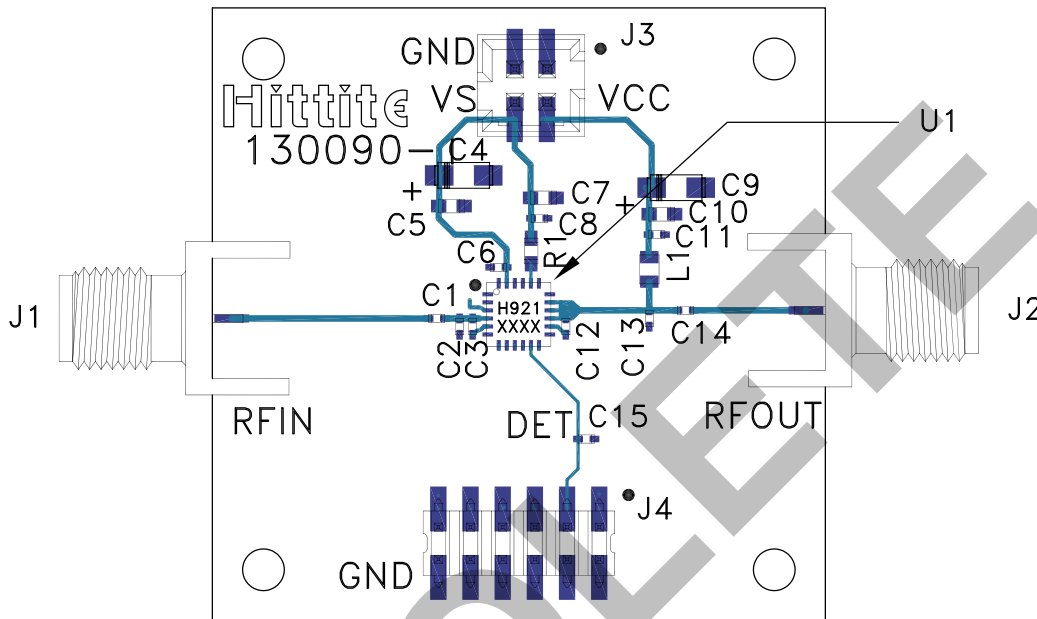

### List of Materials for 1900 MHz Evaluation PCB 130008 [1]

| Item                  | Description                  |
|-----------------------|------------------------------|
| J1 - J2               | PCB Mount SMA Connector      |
| J3 - J4               | 2 mm DC Header               |
| C1                    | 0.9 pF Capacitor, 0402 Pkg.  |
| C2                    | 0.9 pF Capacitor, 0402 Pkg.  |
| C3                    | 1.8 pF Capacitor, 0402 Pkg.  |
| C4, C9                | 2.2 μF Capacitor, Tantalum   |
| C5, C7, C10           | 1000 pF Capacitor, 0603 Pkg. |
| C6, C8, C11, C14, C15 | 100 pF Capacitor, 0402 Pkg.  |
| C12                   | 3.6 pF Capacitor, 0402 Pkg.  |
| C13                   | 2.7 pF Capacitor, 0402 Pkg.  |
| L1                    | 18 nH Inductor, 0402 Pkg.    |
| R1                    | 130 Ohms Resistor, 0603 Pkg. |
| U1                    | HMC921LP4E Linear Amplifier  |
| PCB [2]               | 130090 Evaluation PCB        |

[1] Reference this number when ordering complete evaluation PCB

[2] Circuit Board Material: Rogers 4350 or Arlon 25FR

The circuit board used in this application should use RF circuit design techniques. Signal lines should have 50 Ohm impedance while the package ground leads and exposed paddle should be connected directly to the ground plane similar to that shown. A sufficient number of via holes should be used to connect the top and bottom ground planes. The evaluation board should be mounted to an appropriate heat sink. The evaluation circuit board shown is available from Hittite upon request.



**GaAs HBT MMIC 2 WATT  
POWER AMPLIFIER, 0.4 - 2.7 GHz**

**1900 MHz Application Circuit**

This circuit was used to specify the performance for 1800 - 2000 MHz operation. Contact the HMC Applications Group for assistance in optimizing performance for your application.

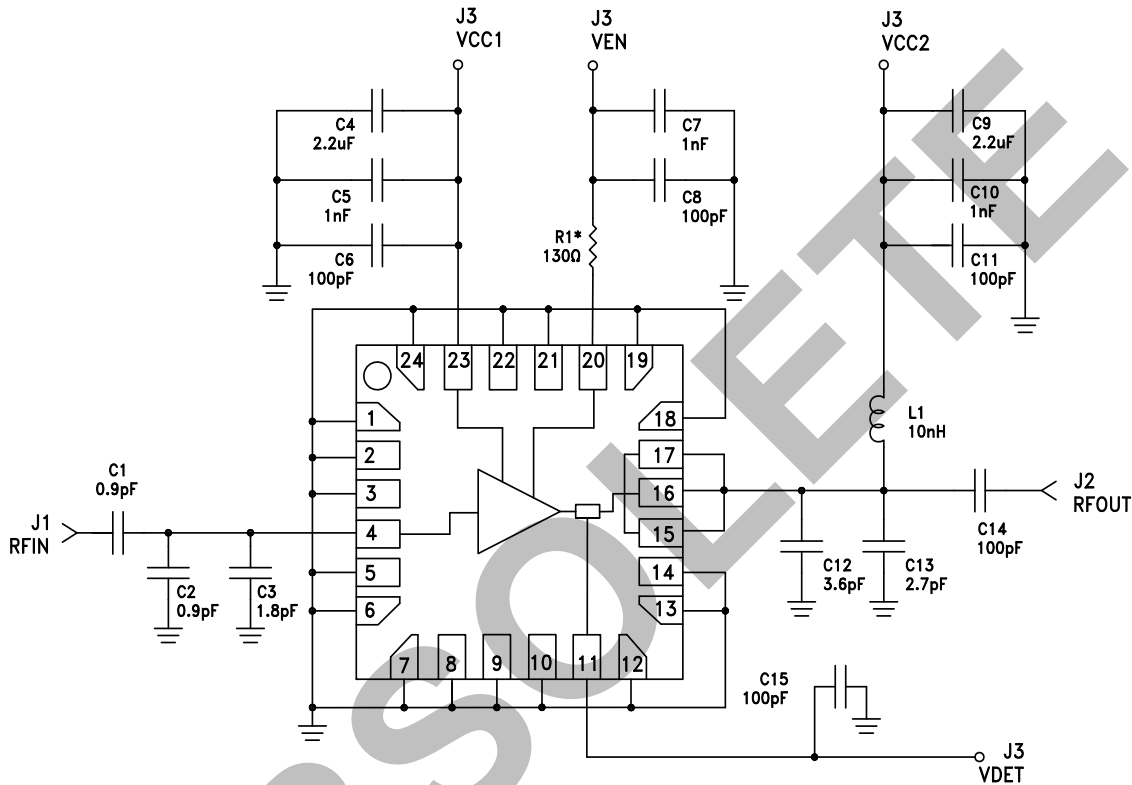

\* R1 = 130 Ohms for 700 mA bias, 270 Ohms for 400 mA bias.



## GaAs HBT MMIC 2 WATT POWER AMPLIFIER, 0.4 - 2.7 GHz

### 2150 MHz Evaluation PCB

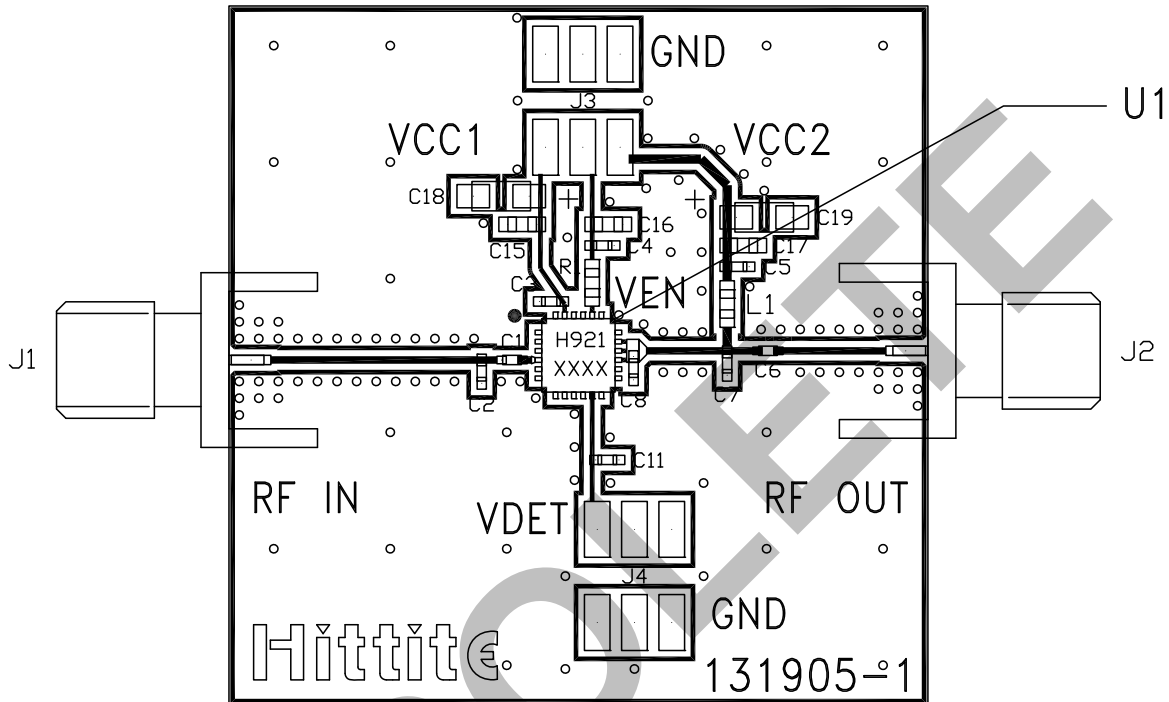

### List of Materials for 2150 MHz Evaluation PCB 131924 [1]

| Item          | Description                  |
|---------------|------------------------------|
| J1, J2        | SMA Connector                |
| J3, J4        | DC Pin                       |
| C1            | 3.9 pF Capacitor, 0402 Pkg.  |
| C2, C8        | 4.3 pF Capacitor, 0402 Pkg.  |
| C7            | 1.8 pF Capacitor, 0402 Pkg.  |
| C3 - C6, C11  | 100 pF Capacitor, 0402 Pkg.  |
| C15, C16, C17 | 1000 pF Capacitor, 0402 Pkg. |
| C18, C19      | 2.2 uF Capacitor, Case A.    |
| R1            | 130 ohms Resistor, 0603 Pkg. |
| L1            | 10 nH Inductor, 0603 Pkg.    |
| U1            | HMC921LP4E Amplifier         |
| PCB [2]       | 131905 Evaluation PCB        |

[1] Reference this number when ordering complete evaluation PCB

[2] Circuit Board Material: Rogers 4350 or Arlon 25 FR

The circuit board used in this application should use RF circuit design techniques. Signal lines should have 50 Ohm impedance while the package ground leads and exposed paddle should be connected directly to the ground plane similar to that shown. A sufficient number of via holes should be used to connect the top and bottom ground planes. The evaluation board should be mounted to an appropriate heat sink. The evaluation circuit board shown is available from Hittite upon request.



**GaAs HBT MMIC 2 WATT  
POWER AMPLIFIER, 0.4 - 2.7 GHz**

**2150 MHz Application Circuit**

This circuit was used to specify the performance for 2000 - 2200 MHz operation. Contact the HMC Applications Group for assistance in optimizing performance for your application.

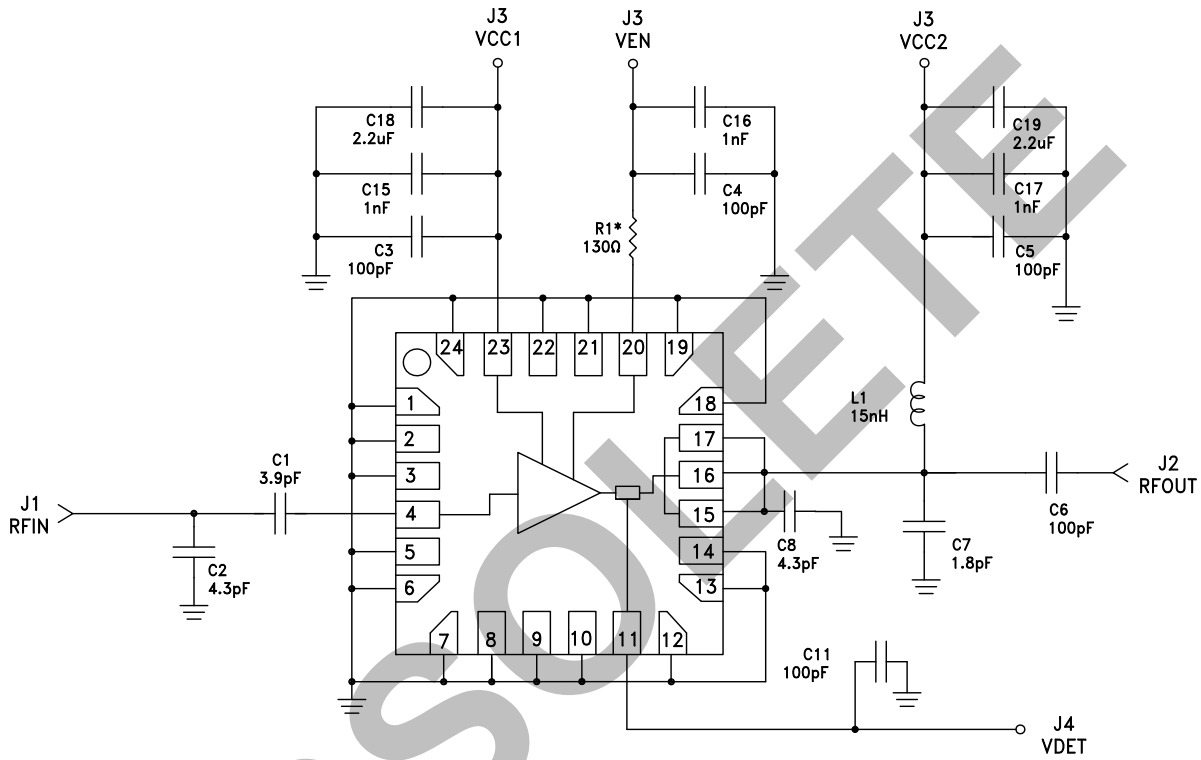

\* R1 = 130 Ohms for 700 mA bias, 270 Ohms for 400 mA bias.



**GaAs HBT MMIC 2 WATT  
POWER AMPLIFIER, 0.4 - 2.7 GHz**

**2700 MHz Evaluation PCB**

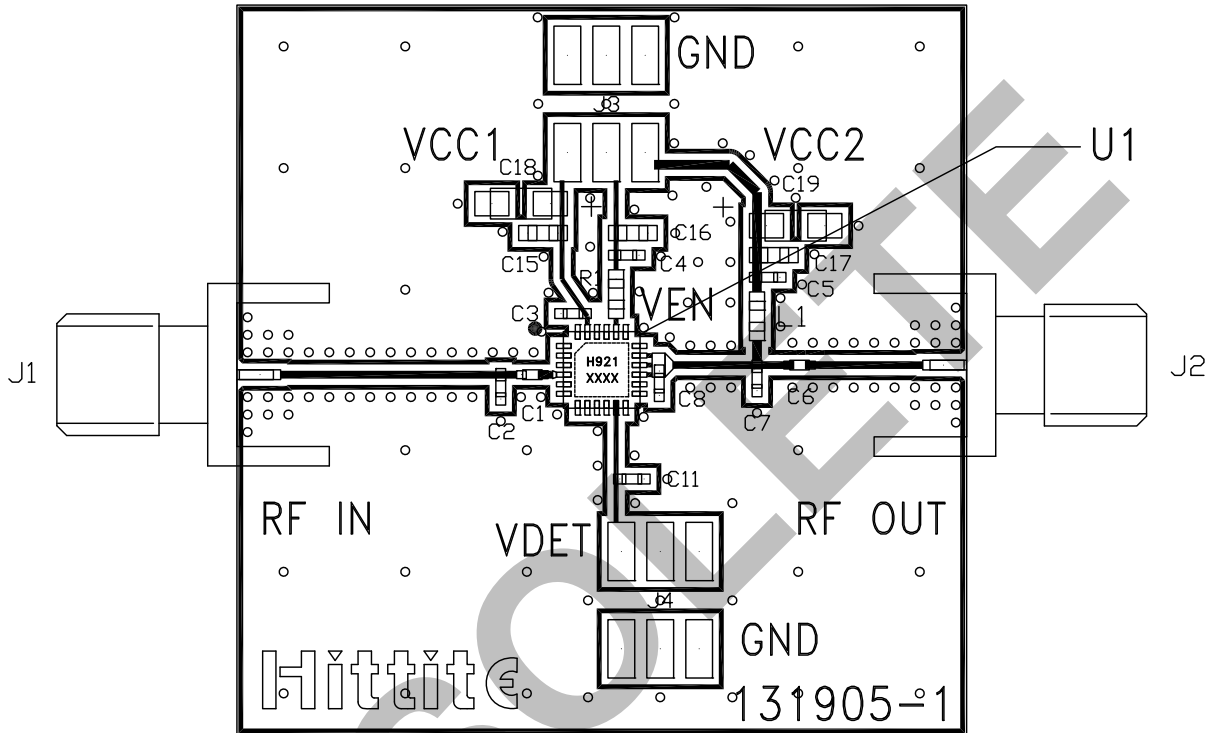

**List of Materials for 2700 MHz Evaluation PCB 131907 [1]**

| Item          | Description                  |
|---------------|------------------------------|
| J1, J2        | SMA Connector                |
| J3, J4        | DC Pin                       |
| C1, C2        | 2.4 pF Capacitor, 0402 Pkg.  |
| C7            | 1.3 pF Capacitor, 0402 Pkg.  |
| C3 - C6, C11  | 100 pF Capacitor, 0402 Pkg.  |
| C15, C16, C17 | 1000 pF Capacitor, 0402 Pkg. |
| C18, C19      | 2.2 uF Capacitor, Case A.    |
| R1            | 130 ohms Resistor, 0603 Pkg. |
| L1            | 10 nH Inductor, 0603 Pkg.    |
| U1            | HMC921LP4E Amplifier         |
| PCB [2]       | 131905 Evaluation PCB        |

[1] Reference this number when ordering complete evaluation PCB

[2] Circuit Board Material: Rogers 4350 or Arlon 25 FR

The circuit board used in this application should use RF circuit design techniques. Signal lines should have 50 Ohm impedance while the package ground leads and exposed paddle should be connected directly to the ground plane similar to that shown. A sufficient number of via holes should be used to connect the top and bottom ground planes. The evaluation board should be mounted to an appropriate heat sink. The evaluation circuit board shown is available from Hittite upon request.





**GaAs HBT MMIC 2 WATT  
POWER AMPLIFIER, 0.4 - 2.7 GHz**

**2700 MHz Application Circuit**

This circuit was used to specify the performance for 2500 - 2800 MHz operation. Contact the HMC Applications Group for assistance in optimizing performance for your application.

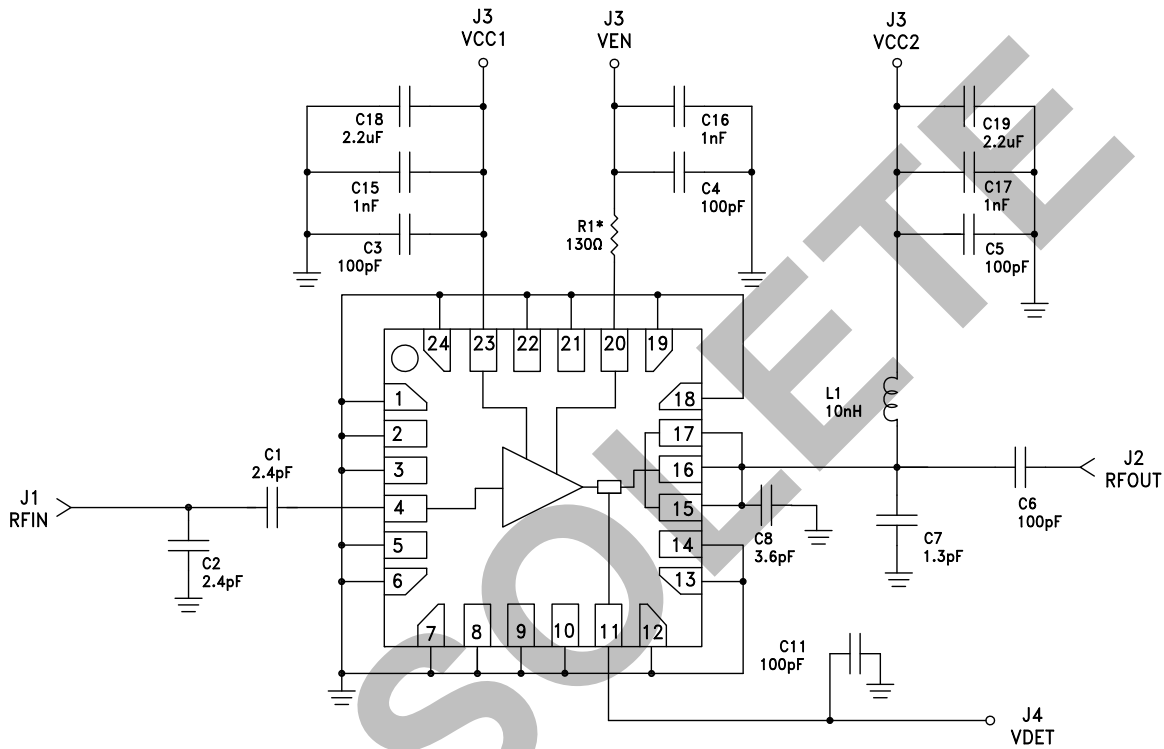

\* R1 = 130 Ohms for 700 mA bias, 270 Ohms for 400 mA bias.

**GaAs HBT MMIC 2 WATT  
POWER AMPLIFIER, 0.4 - 2.7 GHz****Notes:**

OBSOLETE