

G3VM-21PR

MOS FET Relays USOP package with Low Output Capacitance and ON Resistance type (Low C × R)

USOP Package with Low Output Capacitance and ON Resistance

- Load voltage 20V

RoHS Compliant

Refer to "Common Precautions".



NEW

Note: The actual product is marked differently from the image shown here.

Application Examples

- Semiconductor test equipment
- Communication equipment
- Test & measurement equipment
- Data loggers

Package (Unit : mm, Average)

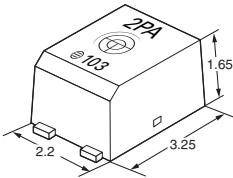

Note: The actual product is marked differently from the image shown here.

Model Number Legend

G3VM-□□□□□
1 2 3 4 5

- | | | |
|---|--|--|
| 1. Load Voltage
2: 20V | 3. Package type
P: USOP 4 pin | 5. Other informations
When specifications overlap, serial code is added in the recorded order. |
| 2. Contact form
1: 1a (SPST-NO) | 4. Additional functions
R: Low On-resistance | |

Ordering Information

Package type	Contact form	Terminals	Load voltage (peak value) *	Continuous load current (peak value) *	Packing/Tape cut		Packing/Tape & reel	
					Model	Minimum package quantity	Model	Minimum package quantity
USOP4	1a (SPST-NO)	Surface-mounting Terminals	20V	200mA	G3VM-21PR10	1 pc.	G3VM-21PR10(TR05)	500 pcs.
				450mA	G3VM-21PR1		G3VM-21PR1(TR05)	
				900mA	G3VM-21PR11		G3VM-21PR11(TR05)	

Note: When ordering tape packing, add "(TR05)" (500pcs/reel) to the model number.
Ask your OMRON representative for orders under 500 pcs. We can supply products with the tape already cut.
Tape-cut USOPs are packaged without humidity resistance. Use manual soldering to mount them.
Refer to common precautions.

* The AC peak and DC value are given for the load voltage and continuous load current.

Absolute Maximum Ratings (Ta = 25°C)

Item		Symbol	G3VM-21PR10	G3VM-21PR1	G3VM-21PR11	Unit	Measurement conditions
Input	LED forward current	IF	50			mA	
	LED forward current reduction rate	ΔIF/°C	-0.5			mA/°C	Ta≥25°C
	LED reverse voltage	VR	5			V	
	Connection temperature	TJ	125			°C	
Output	Load voltage (AC peak/DC)	V _{OFF}	20			V	
	Continuous load current (AC peak/DC)	Io	200	450	900	mA	
	ON current reduction rate	ΔIo/°C	-2.0	-4.5	-12	mA/°C	Ta≥25°C
	Pulse ON current	I _{op}	600	1,300	2,700	mA	t=100ms, Duty=1/10
Connection temperature		TJ	125			°C	
Dielectric strength between I/O *		V _{I-O}	500			V _{rms}	AC for 1 min
Ambient operating temperature		Ta	-40~+85			°C	With no icing or condensation
Ambient storage temperature		T _{stg}	-40~+125			°C	
Soldering temperature		-	260			°C	10s

* The dielectric strength between the input and output was checked by applying voltage between all pins as a group on the LED side and all pins as a group on the light-receiving side.

USOP G3VM-21PR

Electrical Characteristics (Ta = 25°C)

Item		Symbol	G3VM-21PR10	G3VM-21PR1	G3VM-21PR11	Unit	Measurement conditions	
Input	LED forward voltage	V _F	Minimum	1.0			V	I _F =10mA
		Typical	1.15					
		Maximum	1.3					
	Reverse current	I _R	Maximum	10			μA	V _R =5V
	Capacity between terminals	C _T	Typical	15			pF	V=0, f=1MHz
Output	Trigger LED forward current	I _{FT}	Typical	1	0.6		mA	I _O =100mA
		Maximum	3					
	Release LED forward current	I _{FC}	Minimum	0.1			mA	I _{OFF} =10μA
	Maximum resistance with output ON	R _{ON}	Typical	3	0.6	0.18	Ω	I _F =5mA, t<1s I _O =Continuous load current ratings
			Maximum	5	1.2	0.22		
Current leakage when the relay is open	I _{LEAK}	Typical	1			nA	V _{OFF} =20V	
Capacity between terminals	C _{OFF}	Typical	0.8	5	40	pF	V=0, f=100MHz	
		Maximum	1.1	12	—			
Capacity between I/O terminals	C _{I-O}	Typical	0.4			pF	f=1MHz, V _S =0V	
Insulation resistance between I/O terminals	R _{I-O}	Minimum	1000			MΩ	V _{I-O} =500VDC, R _{oH} ≤60%	
		Typical	10 ⁸					
Turn-ON time	t _{ON}	Typical	0.04	0.2	0.5	ms	I _F =5mA, R _L =200Ω, V _{DD} =10V *1	
		Maximum	0.2	0.5	2			
Turn-OFF time	t _{OFF}	Typical	0.13	0.2	0.1			
		Maximum	0.2	0.5	1			
Equivalent rise time	ERT	Typical	—	40	—			
		Maximum	—	90	—			

*1. Turn-ON and Turn-OFF Times

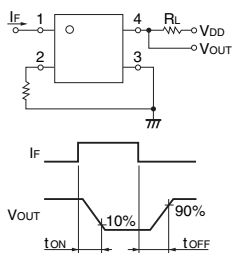

*2. Equivalent Rise Time

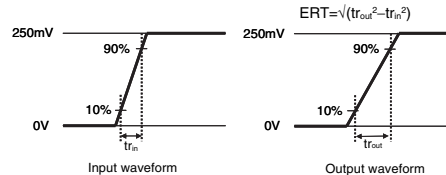

Recommended Operating Conditions

For usage with high reliability, Recommended Operation Conditions is a measure that takes into account the derating of Absolute Maximum Ratings and Electrical Characteristics.

Each item on this list is an independent condition, so it is not simultaneously satisfy several conditions.

Item	Symbol		G3VM-21PR10	G3VM-21PR1	G3VM-21PR11	Unit
Load voltage (AC peak/DC)	V _{DD}	Maximum	16			V
Operating LED forward current	I _F	Minimum	5			mA
		Typical	7.5			
		Maximum	20			
Continuous load current (AC peak/DC)	I _O	Maximum	200	450	900	
Ambient operating temperature	T _a	Minimum	-20			°C
		Maximum	65			

Engineering Data

LED forward current vs. Ambient temperature

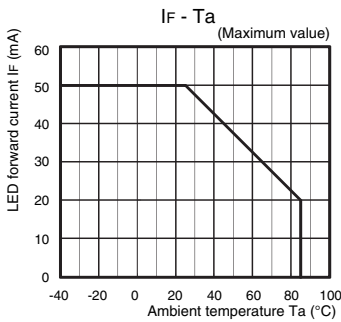

Continuous load current vs. On-state voltage

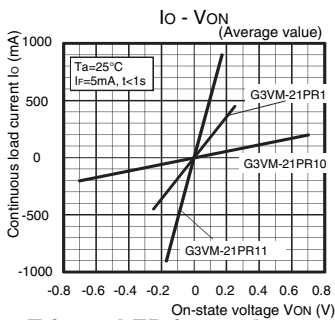

Trigger LED forward current vs. Ambient temperature

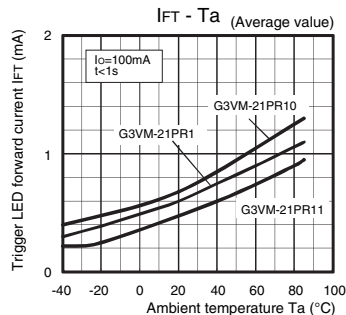

Turn ON, Turn OFF time vs. Ambient temperature

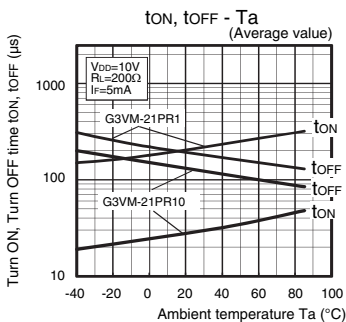

Output terminal capacitance vs. Load voltage

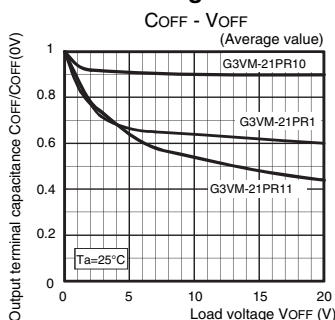

Continuous load current vs. Ambient temperature

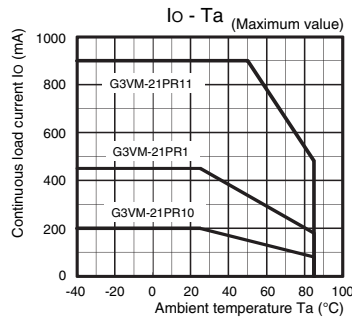

On-state resistance vs. Ambient temperature

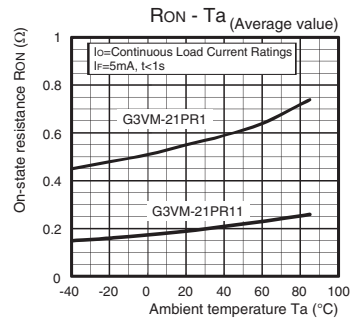

Turn ON, Turn OFF time vs. LED forward current

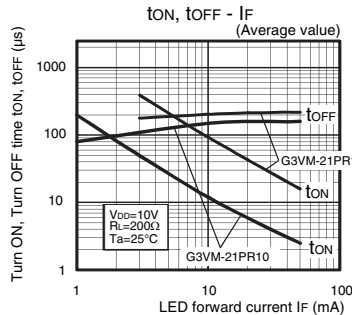

G3VM-21PR11

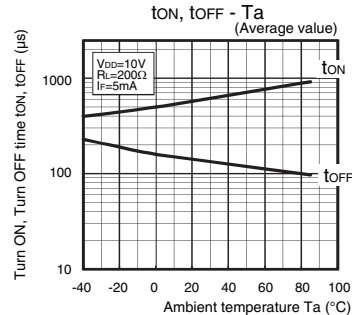

LED forward current vs. LED forward voltage

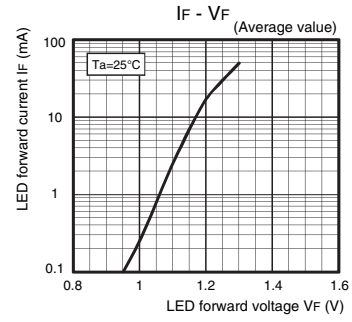

G3VM-21PR10

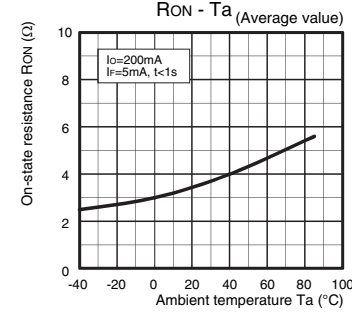

G3VM-21PR11

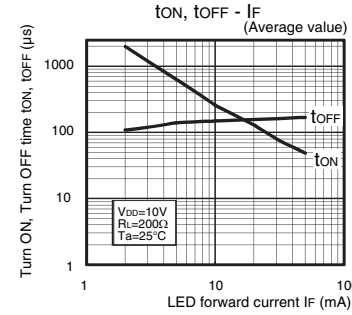

Current leakage vs. Load voltage

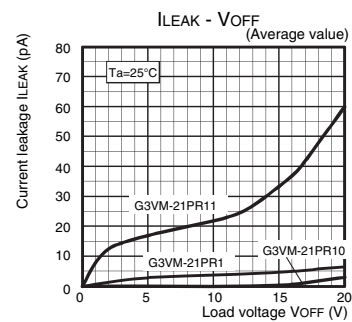

■Appearance / Terminal Arrangement / Internal Connections

■Appearance

USOP (Ultra Small Outline Package)
USOP4 pin

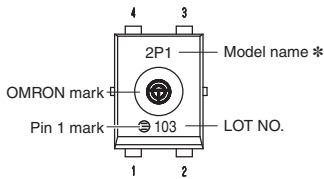

* Actual model name marking for each model

Model	Marking
G3VM-21PR10	2PA
G3VM-21PR1	2P1
G3VM-21PR11	2PB

Note. The actual product is marked differently from the image shown here.

■Terminal Arrangement/Internal Connections (Top View)

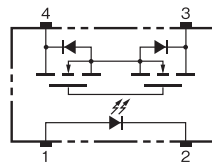

■Dimensions (Unit: mm)

Surface-mounting Terminals

Weight: 0.03g

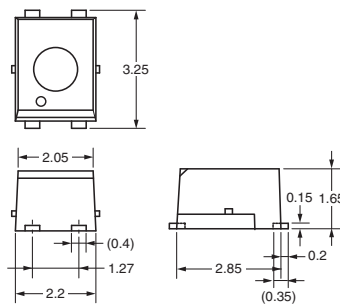
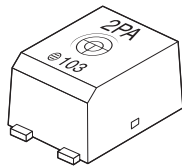

Unless otherwise specified, the dimensional tolerance is ± 0.2 mm.

Actual Mounting Pad Dimensions

(Recommended Value, Top View)

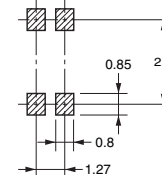

Unless otherwise specified, the dimensional tolerance is ± 0.2 mm.

Note: The actual product is marked differently from the image shown here.

■Approved Standards

UL recognized

Approved Standards	Contact form	File No.
UL recognized	1a (SPST-NO)	E80555

■Safety Precautions

- Refer to "Common Precautions" for all G3VM models.

Please check each region's Terms & Conditions by region website.

OMRON Corporation

Electronic and Mechanical Components Company

Regional Contact

Americas

<https://www.components.omron.com/>

Asia-Pacific

<https://ecb.omron.com.sg/>

Korea

<https://www.omron-ecb.co.kr/>

Europe

<http://components.omron.eu/>

China

<https://www.ecb.omron.com.cn/>

Japan

<https://www.omron.co.jp/ecb/>

© OMRON Corporation 2015 All Rights Reserved.
In the interest of product improvement, specifications are subject to change without notice.

Cat. No. K272-E1-03
0318(0115)(O)