



## SiGe HBT DUAL CHANNEL GAIN BLOCK MMIC AMPLIFIER, DC - 5 GHz

### Typical Applications

The HMC471MS8G / HMC471MS8GE is a dual RF/IF gain block & LO or PA driver:

- Cellular / PCS / 3G
- Fixed Wireless & WLAN
- CATV, Cable Modem & DBS
- Microwave Radio & Test Equipment

### Features

- P1dB Output Power: +20 dBm
- Gain: 20 dB
- Output IP3: +34 dBm
- Supply (Vs): +6V to +12V
- 14.9 mm<sup>2</sup> Ultra Small 8 Lead MSOP

### Functional Diagram

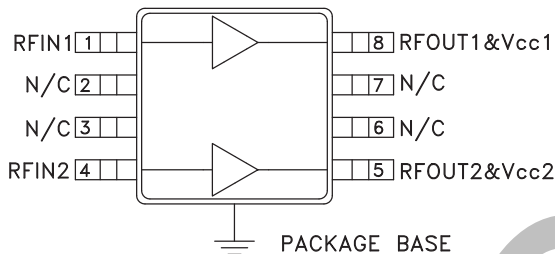

### General Description

The HMC471MS8G & HMC471MS8GE are SiGe HBT Dual Channel Gain Block MMIC SMT amplifiers covering DC to 5 GHz. These versatile products contain two gain blocks, packaged in a single 8 lead plastic MSOP, for use as either separate cascadable 50 Ohm RF/IF gain stages, LO or PA drivers or with both amplifiers combined utilizing external 90° hybrids to create a high linearity driver amplifier. Each amplifier in the HMC471MS8G(E) offers 20 dB of gain, +20 dBm P1dB with a +34 dBm output IP3 at 850 MHz while requiring only 80 mA from a single positive supply. The combined dual amplifier circuit delivers up to +21 dBm P1dB with +36 dBm OIP3 for specific application bands through 4 GHz.

### Electrical Specifications, Vs= 8.0 V, Rbias= 39 Ohm, TA = +25° C

Parameter		Min.	Typ.	Max.	Units
Gain	DC - 1.0 GHz	18.5	21		dB
	1.0 - 2.0 GHz	15.5	17.5		dB
	2.0 - 3.0 GHz	13	15		dB
	3.0 - 4.0 GHz	10.5	12.5		dB
	4.0 - 5.0 GHz	8	10		dB
Gain Variation Over Temperature	DC - 5 GHz		0.008	0.012	dB/ °C
Input Return Loss	DC - 2.0 GHz		12		dB
	2.0 - 4.0 GHz		14		dB
	4.0 - 5.0 GHz		8		dB
Output Return Loss	DC - 1.0 GHz		13		dB
	1.0 - 2.0 GHz		9		dB
	2.0 - 4.0 GHz		7		dB
	4.0 - 5.0 GHz		5		dB
Reverse Isolation	DC - 5 GHz		20		dB
Output Power for 1 dB Compression (P1dB)	0.5 - 1.0 GHz	16	19		dBm
	1.0 - 2.0 GHz	14	17		dBm
	2.0 - 3.0 GHz	11	14		dBm
	3.0 - 4.0 GHz	9	12		dBm
	4.0 - 5.0 GHz	7	10		dBm
Output Third Order Intercept (IP3) (Pout= 0 dBm per tone, 1 MHz spacing)	0.5 - 1.0 GHz		34		dBm
	1.0 - 2.0 GHz		32		dBm
	2.0 - 3.0 GHz		27		dBm
	3.0 - 4.0 GHz		25		dBm
Noise Figure	DC - 4 GHz		3.25		dB
	4.0 - 5.0 GHz		4.0		dB
Supply Current (Icq)			80		mA

Note: Data taken with broadband bias tee on device output. All specifications refer to a single amplifier.



**SiGe HBT DUAL CHANNEL GAIN BLOCK MMIC AMPLIFIER, DC - 5 GHz**

**Broadband Gain & Return Loss**

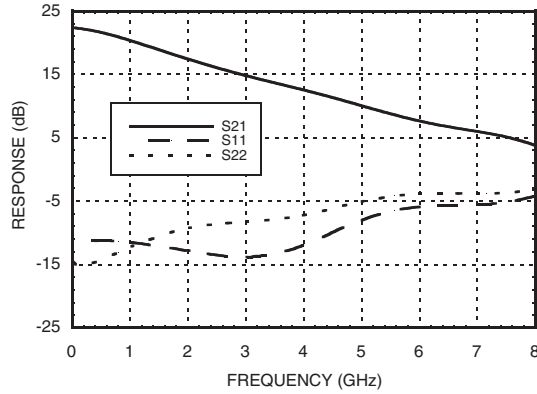

**Gain vs. Temperature**

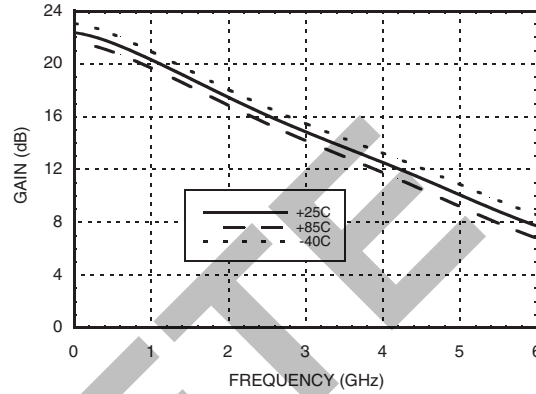

**Input Return Loss vs. Temperature**

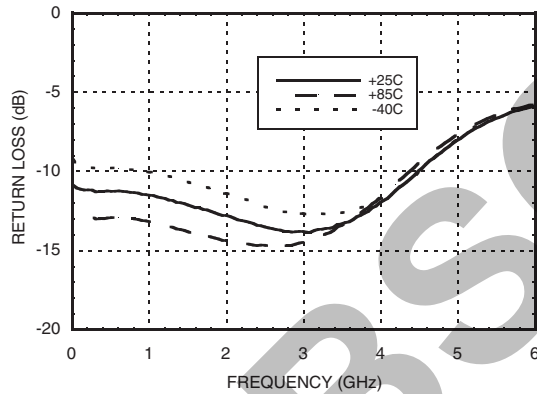

**Output Return Loss vs. Temperature**

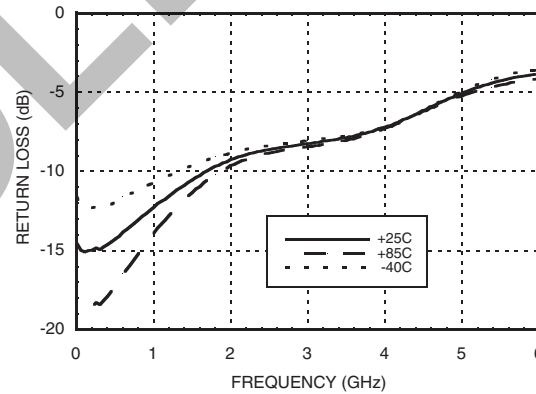

**Reverse Isolation vs. Temperature**

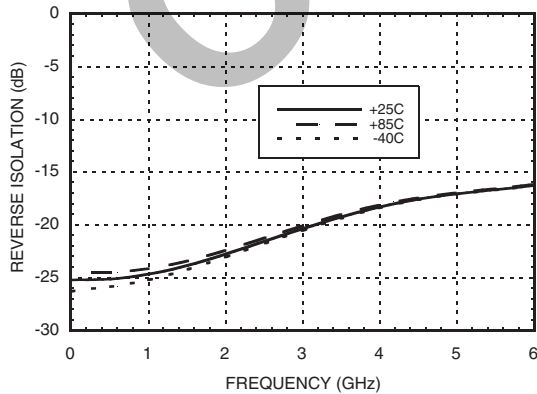

**Noise Figure vs. Temperature**

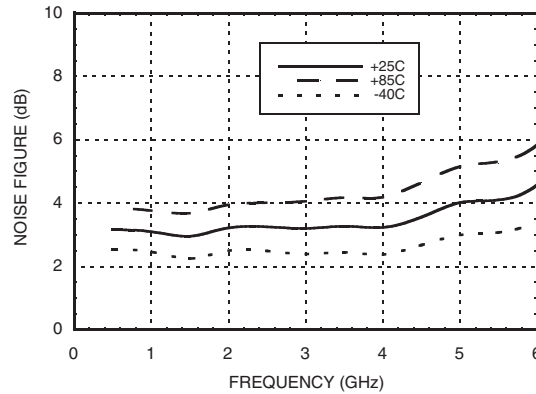

Data shown is of a single amplifier.

Information furnished by Analog Devices is believed to be accurate and reliable. However, no responsibility is assumed by Analog Devices for its use, nor for any infringements of patents or other rights of third parties that may result from its use. Specifications subject to change without notice. No license is granted by implication or otherwise under any patent or patent rights of Analog Devices. Trademarks and registered trademarks are the property of their respective owners.

For price, delivery, and to place orders: Analog Devices, Inc., One Technology Way, P.O. Box 9106, Norwood, MA 02062-9106 Phone: 781-329-4700 • Order online at [www.analog.com](http://www.analog.com) Application Support: Phone: 1-800-ANALOG-D



**SiGe HBT DUAL CHANNEL GAIN BLOCK MMIC AMPLIFIER, DC - 5 GHz**

9

DRIVER & GAIN BLOCK AMPLIFIERS - SMT

**P1dB vs. Temperature**

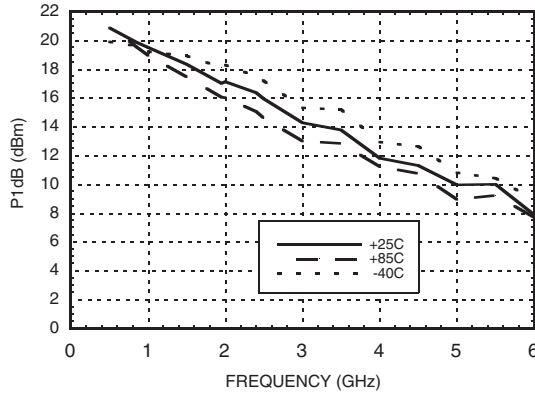

**Psat vs. Temperature**

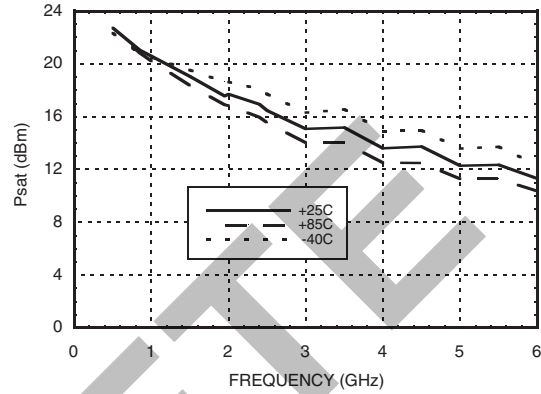

**Output IP3 vs. Temperature**

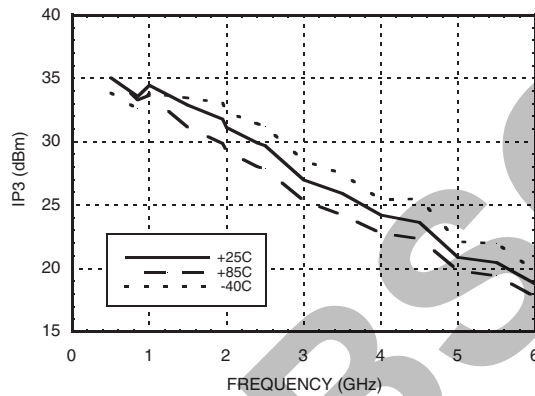

**Gain, Power & OIP3 vs. Supply Voltage for Constant Icc= 80 mA @ 850 MHz**

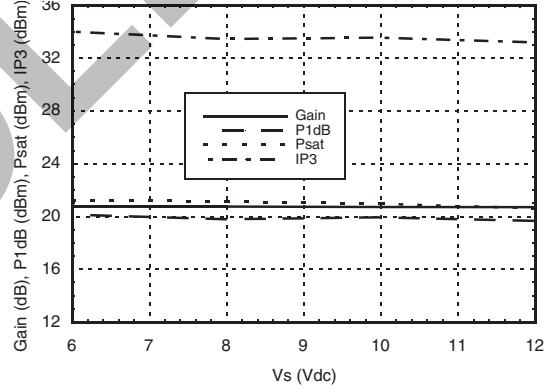

**Vcc vs. Icc Over Temperature for Fixed Vs= 8V, RBIAS= 51 Ohms**

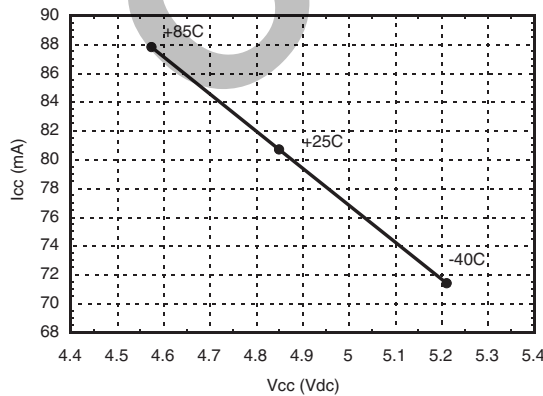

**Cross Channel Isolation**

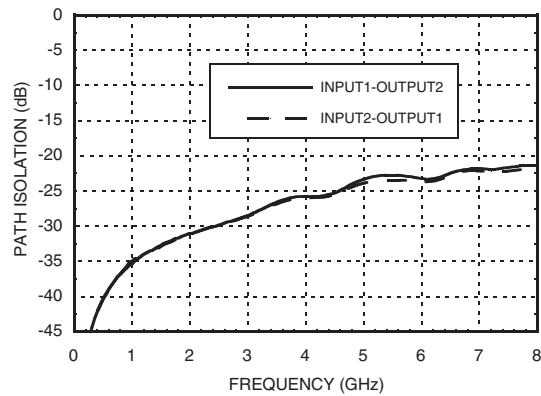

Data shown is of a single amplifier.

Information furnished by Analog Devices is believed to be accurate and reliable. However, no responsibility is assumed by Analog Devices for its use, nor for any infringements of patents or other rights of third parties that may result from its use. Specifications subject to change without notice. No license is granted by implication or otherwise under any patent or patent rights of Analog Devices. Trademarks and registered trademarks are the property of their respective owners.

For price, delivery, and to place orders: Analog Devices, Inc., One Technology Way, P.O. Box 9106, Norwood, MA 02062-9106 Phone: 781-329-4700 • Order online at [www.analog.com](http://www.analog.com) Application Support: Phone: 1-800-ANALOG-D



**SiGe HBT DUAL CHANNEL GAIN BLOCK MMIC AMPLIFIER, DC - 5 GHz**

**Gain\***

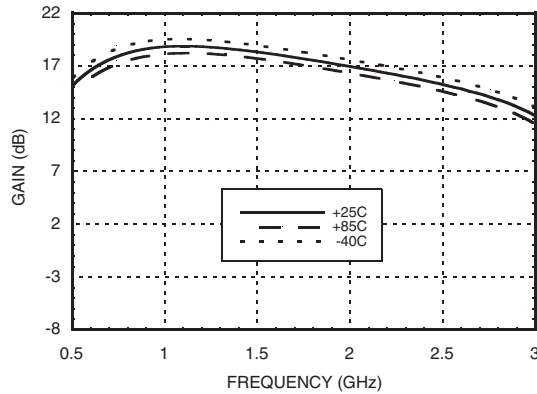

**Input & Output Return Loss \***

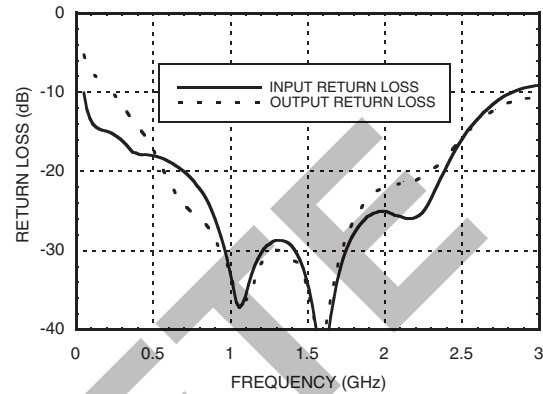

**Reverse Isolation\***

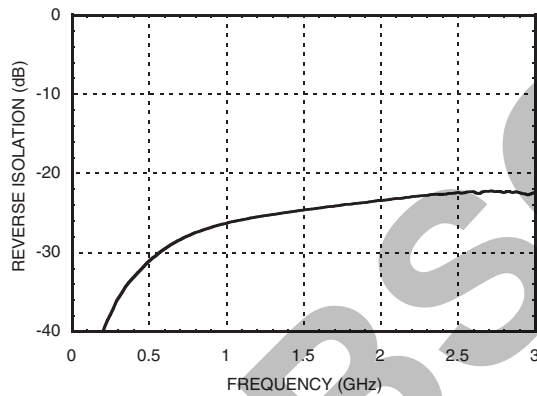

**Output IP3\***

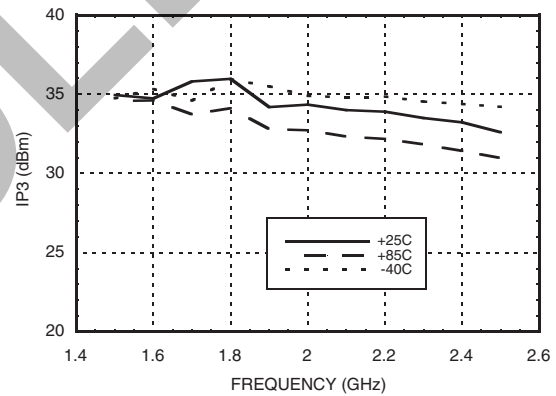

**Output P1dB\***

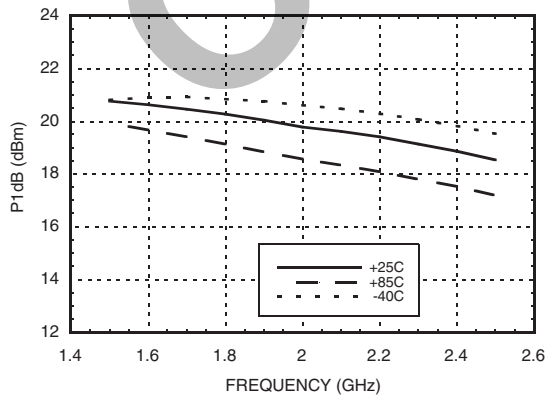

**Output Psat\***

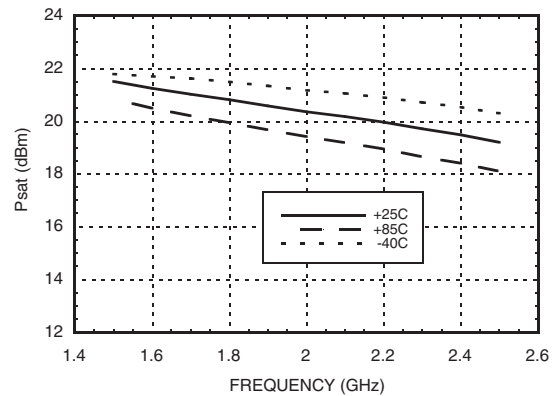

\* Measurements shown are of both channels with 1.5 - 2.5 GHz 90° splitter/combiners on input & output (see application circuit for balanced operation).

Information furnished by Analog Devices is believed to be accurate and reliable. However, no responsibility is assumed by Analog Devices for its use, nor for any infringements of patents or other rights of third parties that may result from its use. Specifications subject to change without notice. No license is granted by implication or otherwise under any patent or patent rights of Analog Devices. Trademarks and registered trademarks are the property of their respective owners.

For price, delivery, and to place orders: Analog Devices, Inc., One Technology Way, P.O. Box 9106, Norwood, MA 02062-9106 Phone: 781-329-4700 • Order online at [www.analog.com](http://www.analog.com) Application Support: Phone: 1-800-ANALOG-D

**SiGe HBT DUAL CHANNEL GAIN  
BLOCK MMIC AMPLIFIER, DC - 5 GHz**



**Absolute Maximum Ratings**

Collector Bias Voltage (Vcc)	+6.0 Vdc
Collector Bias Current (Icc)	100 mA
RF Input Power (RFIN)(Vcc = +4.2 Vdc)	+14 dBm
Junction Temperature	150 °C
Continuous P <sub>diss</sub> (T = 85 °C) (derate 32.6 mW/°C above 85 °C)	2.12 W
Thermal Resistance (junction to ground paddle)	30.7 °C/W
Storage Temperature	-65 to +150 °C
Operating Temperature	-40 to +85 °C
ESD Sensitivity (HBM)	Class 1A



**ELECTROSTATIC SENSITIVE DEVICE  
OBSERVE HANDLING PRECAUTIONS**

**Outline Drawing**

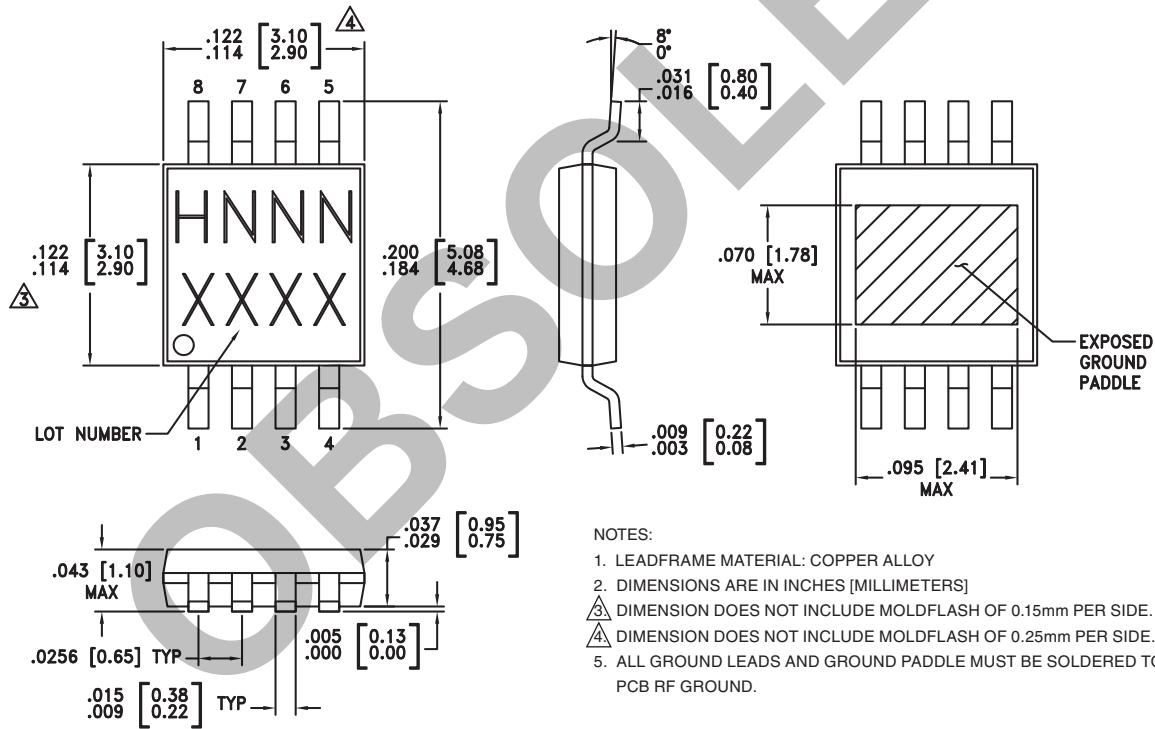

**Package Information**



Part Number	Package Body Material	Lead Finish	MSL Rating	Package Marking <sup>[3]</sup>
HMC471MS8G	Low Stress Injection Molded Plastic	Sn/Pb Solder	MSL1 <sup>[1]</sup>	H471 XXXX
HMC471MS8GE	RoHS-compliant Low Stress Injection Molded Plastic	100% matte Sn	MSL1 <sup>[2]</sup>	H471 XXXX

[1] Max peak reflow temperature of 235 °C

[2] Max peak reflow temperature of 260 °C

[3] 4-Digit lot number XXXX

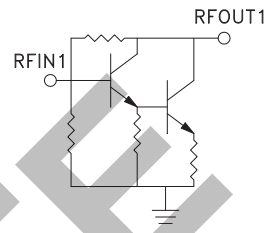
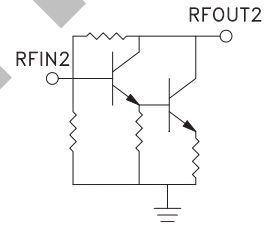

**Pin Descriptions**

Pin Number	Function	Description	Interface Schematic
1	RFIN1	This pin is DC coupled. An off chip DC blocking capacitor is required.	
8	RFOUT1	RF output and DC Bias (Vcc1) for the output stage.	
2, 3, 6, 7	N/C	No connection. These pins may be connected to RF ground. Performance will not be affected.	
4	RFIN2	This pin is DC coupled. An off chip DC blocking capacitor is required.	
5	RFOUT2	RF output and DC Bias (Vcc2) for the output stage.	
Ground Paddle	GND	Ground paddle must be connected to RF/DC ground.	

**SiGe HBT DUAL CHANNEL GAIN  
BLOCK MMIC AMPLIFIER, DC - 5 GHz**

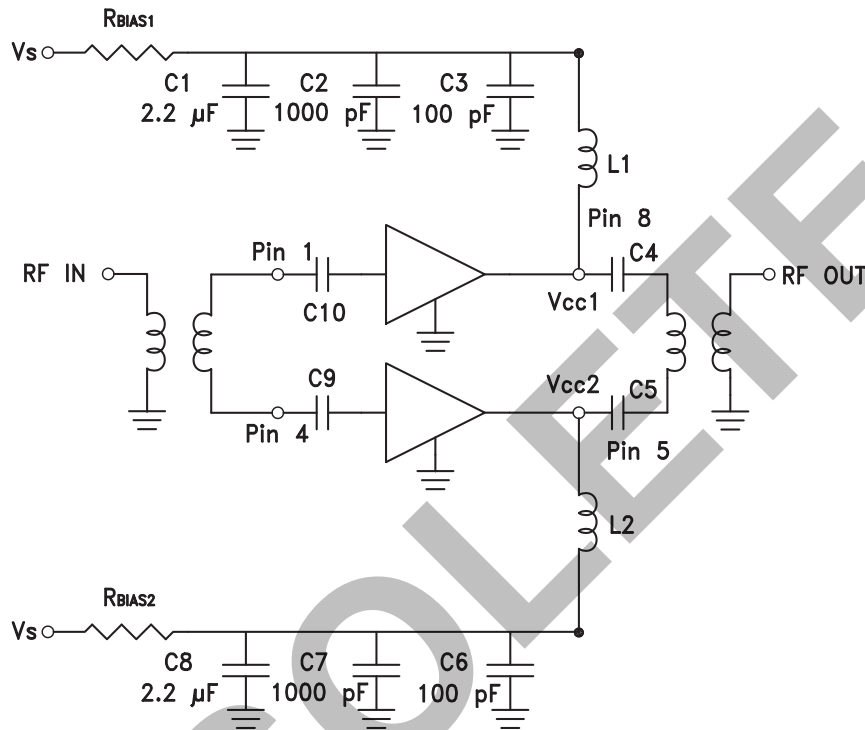

**Application Circuit for Balanced Operation**



Note:

1. External blocking capacitors are required on RFIN and RFOUT.
2. R<sub>BIAS</sub> provides DC bias stability over temperature.

**Recommended Bias Resistor Values  
for I<sub>CC</sub>= 75 mA, R<sub>bias</sub>= (Vs - V<sub>CC</sub>) / I<sub>CC</sub>**

Supply Voltage (Vs)	6V	8V	10V	12V
R <sub>BIAS</sub> VALUE	11 Ω	39 Ω	62 Ω	91 Ω
R <sub>BIAS</sub> POWER RATING	1/4 W	1/2 W	1/2 W	1 W

**Recommended Component Values for Key Application Frequencies**

Component	Frequency (MHz)						
	50	900	1900	2200	2400	3500	5000
L1, L2	270 nH	56 nH	18 nH	18 nH	15 nH	8.2 nH	6.8 nH
C4, C5, C9, C10	0.01 μF	100 pF	100 pF	100 pF	100 pF	100 pF	100 pF

## SiGe HBT DUAL CHANNEL GAIN BLOCK MMIC AMPLIFIER, DC - 5 GHz



### Evaluation PCB

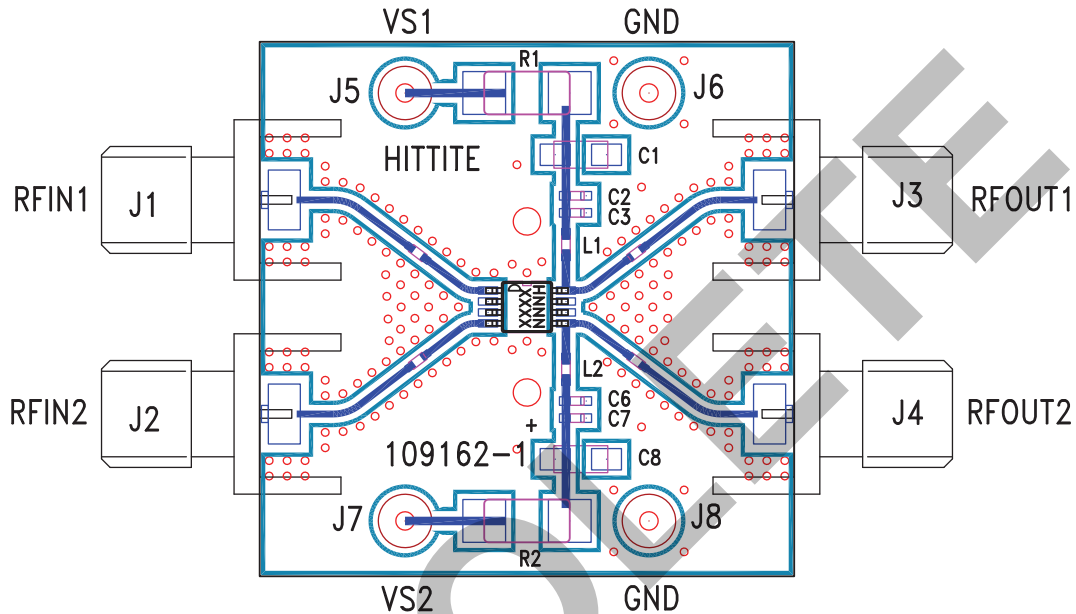

### List of Materials for Evaluation PCB 109185 [1]

Item	Description
J1 - J4	PCB Mount SMA Connector
J5 - J8	DC Pins
L1, L2	Inductor, 0402 Pkg.
C1, C8	2.2 $\mu$ F Capacitor, Tantalum
C2, C7	1000 pF Capacitor, 0402 Pkg.
C3, C6	100 pF Capacitor, 0402 Pkg.
C4, C5, C9, C10	Capacitor, 0402 Pkg.
R1, R2	Resistor, 2010 Pkg.
U1	HMC471MS8G / HMC471MS8GE
PCB [2]	109162 Evaluation PCB

[1] Reference this number when ordering complete evaluation PCB

[2] Circuit Board Material: Rogers 4350

The circuit board used in the final application should use RF circuit design techniques. Signal lines should have 50 ohm impedance while the package ground leads and package bottom should be connected directly to the ground plane similar to that shown. A sufficient number of via holes should be used to connect the top and bottom ground planes. The evaluation board should be mounted to an appropriate heat sink. The evaluation circuit board shown is available from Hittite upon request.