

Connector Location A

Connector Location B

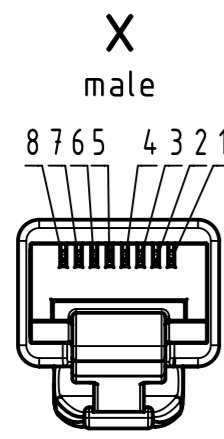

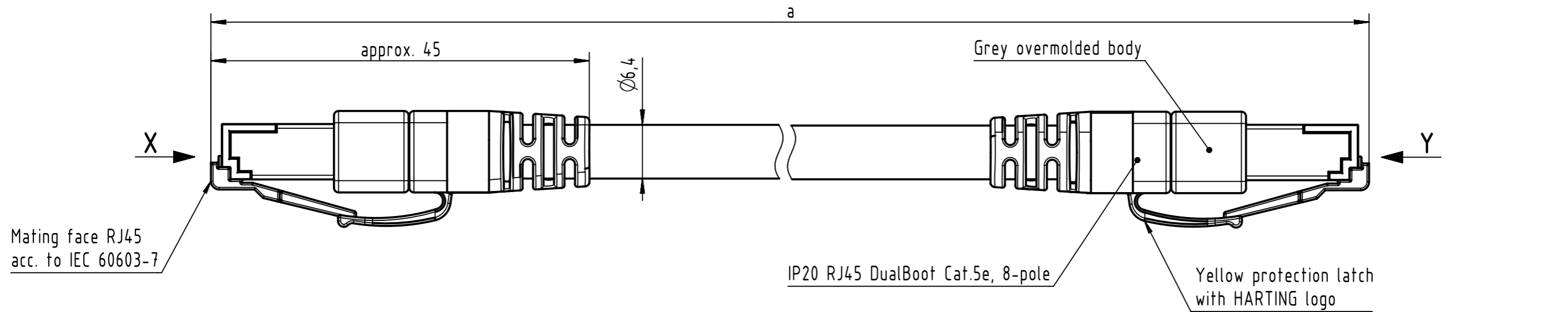
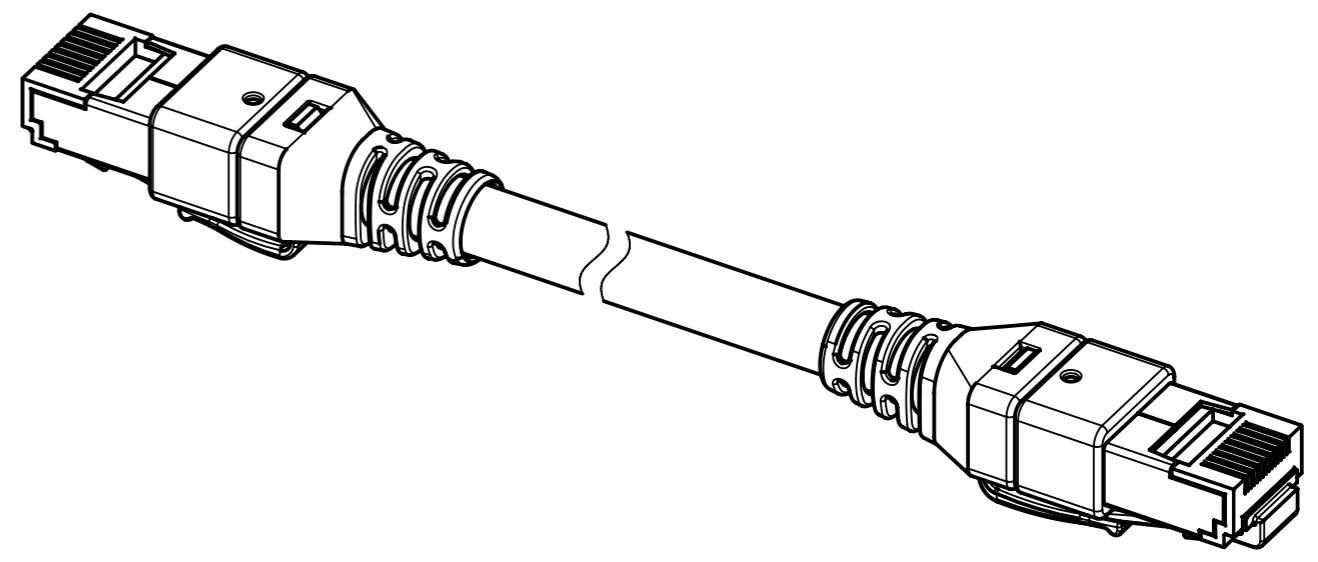
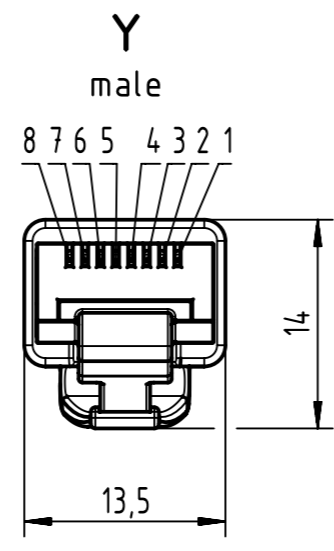
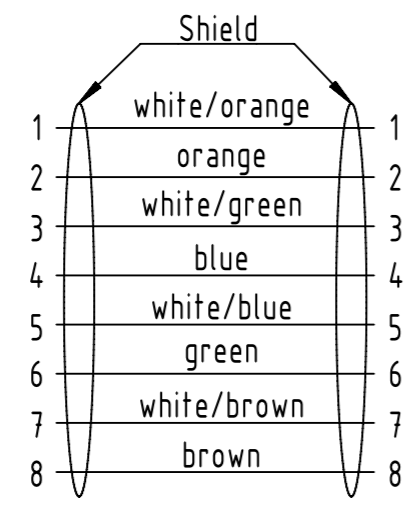

Loading Plan  
acc. to TIA/EIA 568B



**NOTE:**  
 For lengths < 1.0m:  
 - relative positioning of the connectors to each other will be as presented in the drawing, however with an admissible angular deviation around cable axis of ± 30°  
 For lengths ≥ 1.0m:  
 -relative positioning of the connectors to each other not obligatory

Temperature range:  
 - Fixed installation: -30°C ... +75°C  
 - Dynamic installation: -5°C ... +50°C

	All rights reserved Department HCS - RO HARTING Customised Solutions D-32339 Espelkamp	All Dimensions in mm	Tech. Character.	Free size tol.	According to production drawing
		Created by 405181 Hadar	Inspected by COSTEA Costea	Standardisation MUNTEANV Muntean	Date 2021-03-16
		Title RJ1 cable 4x2xAWG26/7 CAT5e PUR			Doc-Key / ECM-Nr. 100170398/UGD/016/N 500000191195
		Type TB	Number 094747470XX		Rev. N Page 1/2

1	2	3	4	5	6	7	8
A							
	34	09474747033		17			
	33	09474747032		16			
	32	09474747022		15			
	31	09474747031		14			
	30	09474747035		12			
B	29	09474747030		11			
	28	09474747021		10			±1%
	27	09474747020		9			
	26	09474747019		8			
	25	09474747018		7.5			
	24	09474747017		7			
	23	09474747043		6.3			
C	22	09474747016		6			
	21	09474747042		5.5			
	20	09474747015		5			
	19	09474747041		4.3			
	18	09474747014	4x2xAWG 26/7 S/FTP Cat.5e, PUR, yellow	4			
	17	09474747024		3.5			
	16	09474747013		3			
D	15	09474747012		2.5			
	14	09474747011		2			+0.040
	13	09474747037		1.8			
	12	09474747010		1.5			
	11	09474747038		1.2			
	10	09474747009		1			
	9	09474747008		0.9			
E	8	09474747007		0.8			
	7	09474747006		0.7			
	6	09474747005		0.6			
	5	09474747004		0.5			
	4	09474747003		0.4			+0.020
	3	09474747002		0.3			
	2	09474747001		0.2			
F	1	09474747039		0.16			
	<b>Cont. no.</b>	<b>Part no.</b>	<b>Type of cable</b>	<b>Dim. a[m]</b>			
	43	09474747040		60			
	42	09474747029		50			
	41	09474747036		48			
	40	09474747028	4x2xAWG 26/7 S/FTP Cat.5e, PUR, yellow	40			±1%
	39	09474747026		35			
	38	09474747027		30			
	37	09474747025		25			
	36	09474747023		20			
	35	09474747034		18			
	<b>Cont. no.</b>	<b>Part no.</b>	<b>Type of cable</b>	<b>Dim. a[m]</b>			
	 All Dimensions in mm		Tech. Character.	Free size tol.	According to production drawing		
	 All rights reserved Department HCS - RO		Created by 405181 Hadar	Inspected by COSTEA Costea	Standardisation MUNTEANV Muntean	Date 2021-03-16	State Final Release
	HARTING Customised Solutions D-32339 Espelkamp		Title RJ1 cable 4x2xAWG26/7 CAT5e PUR		Doc-Key / ECM-Nr. 100170398/UGD/016/N 500000191195		
		Type TB	Number 094747470XX		Rev. N	Page 2/2	