

Overview of Physical Attributes

L, M and R Series

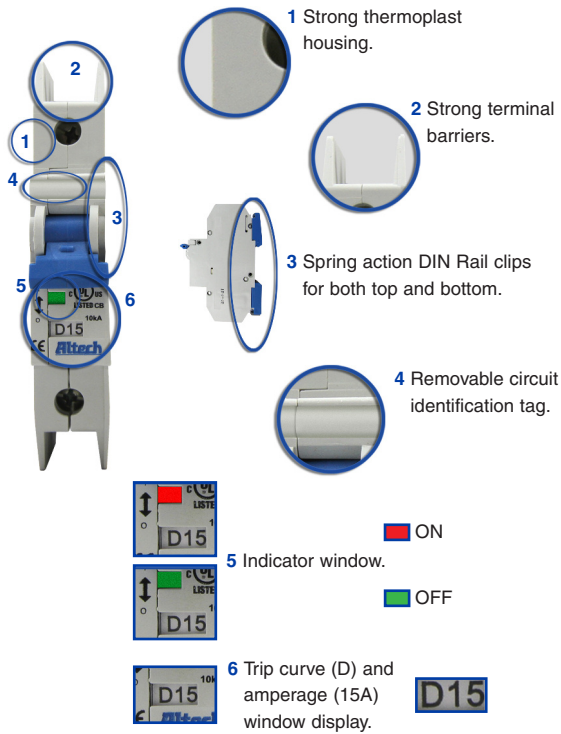

Ordering Nomenclature

L, M and R Series

EXAMPLE

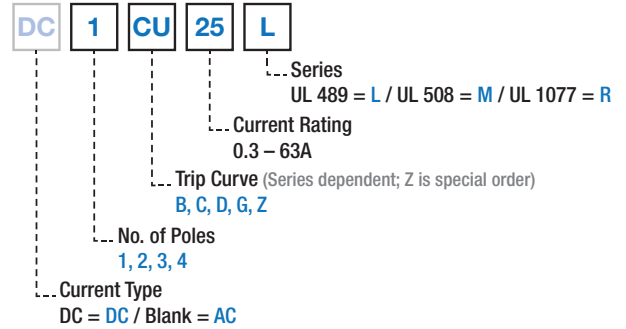

UL 489

L Series, AC or DC UL489 Miniature Molded Case Circuit Breakers

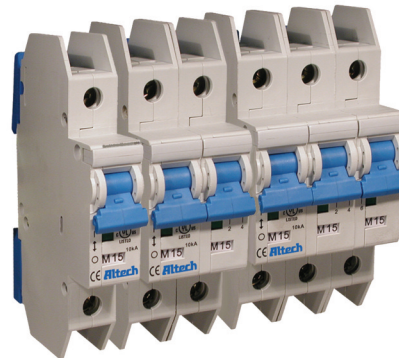

Current/ Voltage Rating

AC Version (one device - dual voltage ratings) 0.2-63A/ 240V AC, 0.2-32A/ 480Y/277VAC

DC Version 0.2-63A/ 125/ 250V DC

Poles 1, 2, 3 (4 poles available upon request.)

Trip Characteristics C, D; AC and DC

Interrupting Capacity 10kA

Calibration Temperature 40°C (104°F)

Ambient Temperature -25°C to 60°C (-13°F to 140°F)

Storage Temperature -25°C to 75°C (-13°F to 167°F)

Terminal Size Acceptability and Terminal Torque
14-3 AWG: 17.7 lb-in. (2.0 Nm)
18-16 AWG: 25 lb-in. (2.8 Nm)

Electrical Life 6,000 switching cycles ON/ OFF

Mechanical Life 10,000 switching cycles ON/ OFF

Terminal Protection Degree IP20 at front

Mounting Orientation In any plane

Accessories (see page 12-13)

- Auxiliary Contact
- Shunt Trip
- Neutral Pole
- Undervoltage (special order)
- Front Mounting Kit with hardware
- Lock-out Adapter

UL 508

M-Series - UL508 Manual Motor Controller with Disconnecting Mean



Current/ Voltage Rating

AC Version	0.5-63A / 480Y/ 277V AC
DC Rating	
Poles	1, 2, 3 (4 poles available upon request.)
Trip Characteristics	B, C, D, G
Short Circuit Withstand Rating (UL/CSA - Ratings)	0.5-6A (RC): 10kA with no back-up fuse 8-63A (RC): 10kA with UL-listed Class J back-up fuse; 5kA with no back-up fuse
Calibration Temperature	30°C (86°F)
Ambient Temperature	-25°C to 60°C (-13°C to 140°F)
Storage Temperature	-25°C to 75°C (-13°C to 167°F)
Terminal Size Acceptability and Terminal Torque	14-3 AWG: 17.7 lb-in. (2.0 Nm) 18-16 AWG: 25 lb-in. (2.8 Nm)
Terminal Protection Degree	IP20
Mounting Orientation	In any plane
Horsepower Ratings	see catalog

Accessories (see page 22-23)

- Auxiliary Contact
- Shunt Trip
- Neutral Pole
- Undervoltage (special order)
- Lock-out Adapter
- Front Mounting Kit with hardware

UL 1077

R Series UL1077 Recognized Supplementary Protector



Current/ Voltage Rating

AC Version	0.5-63A / 480Y/ 277V AC
Poles	1, 2, 3 (4 poles available upon request.)
Trip Characteristics	B, C, D
Short Circuit Withstand Rating	0.5-6A (RC): 10kA with no back-up fuse 8-63A (RC): 10kA with UL-listed Class J back-up fuse; 5kA with no back-up fuse
Calibration Temperature	30°C (86°F)
Ambient Temperature	-25°C to 60°C (-13° to 140°F)
Storage Temperature	-25°C to 75°C (-13° to 167°F)
Terminal Size Acceptability and Torque	14-3 AWG: 17.5 lb-in. (2.0 Nm) 18-16 AWG / 25 lb-in.(2.8 Nm)
Electrical Life	6,000 switching scycles ON/ OFF
Mechanical Life	10,000 cycles ON/ OFF
Terminal Protection Degree	IP20 at front
Mounting Orientation	In any plane

Accessories (see page 30-31)

- Auxiliary Contact
- Shunt Trip
- Neutral Pole
- Undervoltage (special order)
- Lock-out Adapter

M-Series

M-Series - UL508 Manual Motor Controller with Disconnecting Mean

- DIN Rail Mounted
- 17.5mm width per pole
- Thermal Magnetic
- 480Y/277V AC, 50/60Hz
- 10kA Short Circuit Withstand Capacity
- Positive Trip indicator (Green - off/tripped, Red - on)
- Applications Include:
 - AC Motor Starting, Across the Line
 - AC General Use

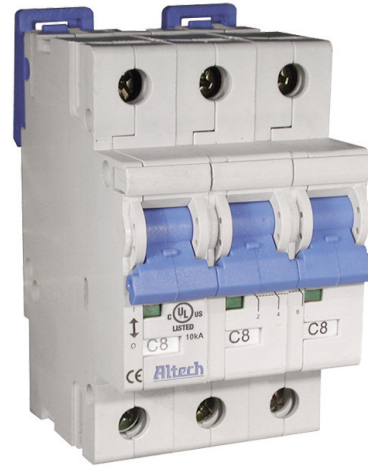

Voltage Rating	480Y/277VAC
Short Circuit Withstand Rating (UL - Ratings)	0.5-6A (RC): 10kA with no back-up fuse 8-63A (RC): 10kA with UL-listed Class J back-up fuse; 5kA with no back-up fuse
Interrupting Capacity (IEC/EN60898/60947-2)	0.5-63A (RC): 10kA
Calibration Temperature	30°C (86°F)
Operating Temperature	-25° to 60°C (-13° to 140°F)
Storage Temperature	-25° to 75°C (-13° to 167°F)
Terminal Size Acceptability: and Torque	14-3 AWG: 17.5 lb-in. (2.0 Nm) 18-16 AWG: 25 lb-in. (2.8 Nm)
Terminal Protection Degree	IP20
Vibration Resistance	3g (8-50Hz)

Indicator window



Trip curve and amperage window display.

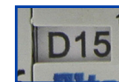

SHORT CIRCUIT WITHSTAND RATINGS FOR M-SERIES MANUAL MOTOR CONTROLLER

Trip Curve	Amp Range	Backup Protection	
		UL-Listed Class J Fuse up to 10kA	No Backup Fuse Required up to:
All	0.5 - 6A	4xRC*	10kA
All	8 - 63A	4xRC*	5kA

*up to nearest rated current

DC voltage rating: 48 VDC (self-certified).

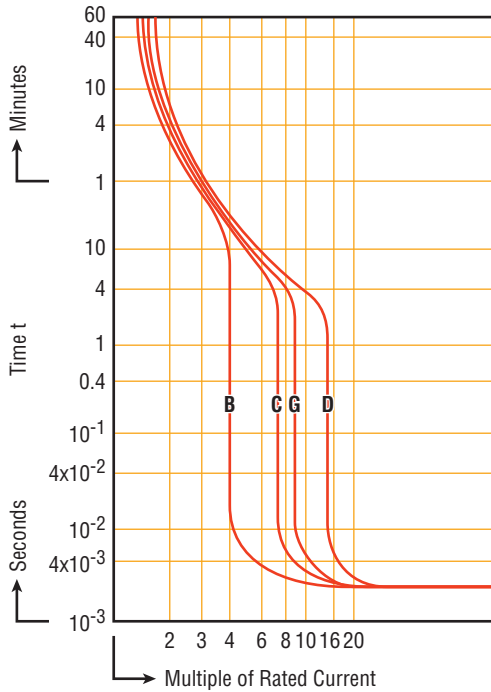

Time versus Current Trip Curve

For the exact trip curve, please refer to page 20

Dimensions in mm side view

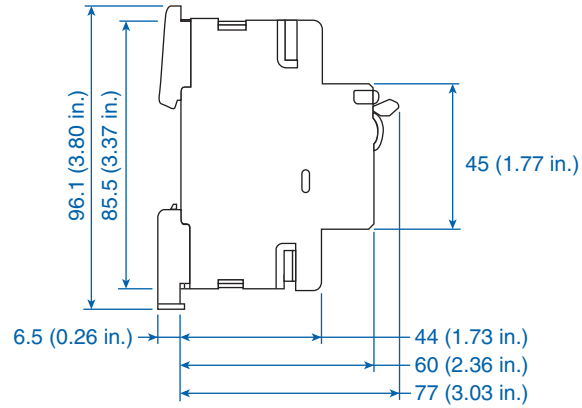

1 POLE

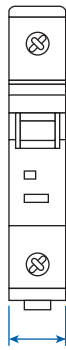

2 POLE

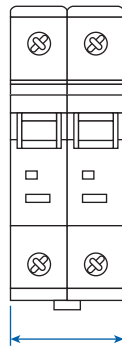

3 POLE

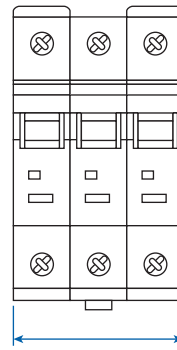

Trip-Characteristics*				Applications									
Characteristic Trip Boundaries				Lighting Wiring Protection	Business Equipment	Transformers	Power Supplies	Motors			General Electronics	Solenoid	Reactive Load
Thermal Trip		Magnetic Trip						Heaters	General	Low Inrush			
Must not Trip >100ms	Must Trip <1hr	Must not Trip >100ms	Must Trip at 100ms	Control Circuits	Appliances								
B-Characteristics													
1.13xRC	1.45xRC	3xRC	5xRC										
C-Characteristics													
1.13xRC	1.45xRC	5xRC	10xRC										
D-Characteristics													
1.13xRC	1.45xRC	10xRC	20xRC										
G-Characteristics													
1.05xRC	1.35xRC	8xRC	10xRC										

*The value of each characteristic is shown vertically beneath its corresponding heading.



Warning!

This information should only be used as a selection guide. The use of a Miniature Circuit Breaker/Manual Motor Controller in an application with a certain Trip-Characteristic always requires prototype testing! It is the responsibility of the circuit design engineer to select the appropriate Miniature Circuit Breaker/Manual Motor Controller for their specific application.

B-Trip Characteristic

Application Examples:

Business equipment, wiring protection, lighting, appliances, control circuits and some electronic applications. Relatively long thermal trip delay but low magnetic trip point.



One Pole

Rated Current	Type/ Cat. No.
0.5A	1BU05M
1.0A	1BU1M
2.0A	1BU2M
3.0A	1BU3M
4.0A	1BU4M
5.0A	1BU5M
6.0A	1BU6M
8.0A	1BU8M
10A	1BU10M
12A	1BU12M
13A	1BU13M
15A	1BU15M
16A	1BU16M
20A	1BU20M
25A	1BU25M
30A	1BU30M
32A	1BU32M
40A	1BU40M
50A	1BU50M
60A	1BU60M
63A	1BU63M

Standard Pack: 12

Weight:

0.5A - 63A: 1.6kg (3.54 lb.)



Two Pole

Rated Current	Type/ Cat. No.
0.5A	2BU05M
1.0A	2BU1M
2.0A	2BU2M
3.0A	2BU3M
4.0A	2BU4M
5.0A	2BU5M
6.0A	2BU6M
8.0A	2BU8M
10A	2BU10M
12A	2BU12M
13A	2BU13M
15A	2BU15M
16A	2BU16M
20A	2BU20M
25A	2BU25M
30A	2BU30M
32A	2BU32M
40A	2BU40M
50A	2BU50M
60A	2BU60M
63A	2BU63M

Standard Pack: 6

Weight:

0.5A - 63A: 1.6kg (3.54 lb.)



Three Pole

Rated Current	Type/ Cat. No.
0.5A	3BU05M
1.0A	3BU1M
2.0A	3BU2M
3.0A	3BU3M
4.0A	3BU4M
5.0A	3BU5M
6.0A	3BU6M
8.0A	3BU8M
10A	3BU10M
12A	3BU12M
13A	3BU13M
15A	3BU15M
16A	3BU16M
20A	3BU20M
25A	3BU25M
30A	3BU30M
32A	3BU32M
40A	3BU40M
50A	3BU50M
60A	3BU60M
63A	3BU63M

Standard Pack: 4

Weight:

0.5A - 63A: 1.66kg (3.67 lb.)

Four Pole
Please contact
Altech.

Non-standard current ratings available. Minimum quantities may apply. Please contact Altech for further details.

C-Trip Characteristic

Application Examples: Lighting, wiring protection, appliances, business equipment, and control circuit applications. Relatively long thermal trip delay and medium magnetic trip point.



One Pole

Rated Current	Type/ Cat. No.
0.5A	1CU05M
1.0A	1CU1M
2.0A	1CU2M
3.0A	1CU3M
4.0A	1CU4M
5.0A	1CU5M
6.0A	1CU6M
8.0A	1CU8M
10A	1CU10M
12A	1CU12M
13A	1CU13M
15A	1CU15M
16A	1CU16M
20A	1CU20M
25A	1CU25M
30A	1CU30M
32A	1CU32M
40A	1CU40M
50A	1CU50M
60A	1CU60M
63A	1CU63M

Standard Pack: 12

Weight:

0.5A - 63A: 1.6kg (3.54 lb.)



Two Pole

Rated Current	Type/ Cat. No.
0.5A	2CU05M
1.0A	2CU1M
2.0A	2CU2M
3.0A	2CU3M
4.0A	2CU4M
5.0A	2CU5M
6.0A	2CU6M
8.0A	2CU8M
10A	2CU10M
12A	2CU12M
13A	2CU13M
15A	2CU15M
16A	2CU16M
20A	2CU20M
25A	2CU25M
30A	2CU30M
32A	2CU32M
40A	2CU40M
50A	2CU50M
60A	2CU60M
63A	2CU63M

Standard Pack: 6

Weight:

0.5A - 63A: 1.6kg (3.54 lb.)



Three Pole

Rated Current	Type/ Cat. No.
0.5A	3CU05M
1.0A	3CU1M
2.0A	3CU2M
3.0A	3CU3M
4.0A	3CU4M
5.0A	3CU5M
6.0A	3CU6M
8.0A	3CU8M
10A	3CU10M
12A	3CU12M
13A	3CU13M
15A	3CU15M
16A	3CU16M
20A	3CU20M
25A	3CU25M
30A	3CU30M
32A	3CU32M
40A	3CU40M
50A	3CU50M
60A	3CU60M
63A	3CU63M

Standard Pack: 4

Weight:

0.5A - 63A: 1.66kg (3.67 lb.)

**Four Pole
Please contact
Altech.**

Non-standard current ratings available. Minimum quantities may apply. Please contact Altech for further details.

Introduction

UL 489

UL 508

UL 1077

Busbars

ANNEX

D-Trip Characteristic

Application Examples:

Control transformers, power supplies and reactive loads. Relatively long thermal trip delay and very high magnetic trip point.



One Pole

Rated Current	Type/ Cat. No.
0.5A	1DU05M
1.0A	1DU1M
2.0A	1DU2M
3.0A	1DU3M
4.0A	1DU4M
5.0A	1DU5M
6.0A	1DU6M
8.0A	1DU8M
10A	1DU10M
12A	1DU12M
13A	1DU13M
15A	1DU15M
16A	1DU16M
20A	1DU20M
25A	1DU25M
30A	1DU30M
32A	1DU32M
40A	1DU40M
50A	1DU50M
60A	1DU60M
63A	1DU63M

Standard Pack: 12

Weight:

0.5A - 63A: 1.6kg (3.54 lb.)



Two Pole

Rated Current	Type/ Cat. No.
0.5A	2DU05M
1.0A	2DU1M
2.0A	2DU2M
3.0A	2DU3M
4.0A	2DU4M
5.0A	2DU5M
6.0A	2DU6M
8.0A	2DU8M
10A	2DU10M
12A	2DU12M
13A	2DU13M
15A	2DU15M
16A	2DU16M
20A	2DU20M
25A	2DU25M
30A	2DU30M
32A	2DU32M
40A	2DU40M
50A	2DU50M
60A	2DU60M
63A	2DU63M

Standard Pack: 6

Weight:

0.5A - 63A: 1.6kg (3.54 lb.)



Three Pole

Rated Current	Type/ Cat. No.
0.5A	3DU05M
1.0A	3DU1M
2.0A	3DU2M
3.0A	3DU3M
4.0A	3DU4M
5.0A	3DU5M
6.0A	3DU6M
8.0A	3DU8M
10A	3DU10M
12A	3DU12M
13A	3DU13M
15A	3DU15M
16A	3DU16M
20A	3DU20M
25A	3DU25M
30A	3DU30M
32A	3DU32M
40A	3DU40M
50A	3DU50M
60A	3DU60M
63A	3DU63M

Standard Pack: 4

Weight:

0.5A - 63A: 1.66kg (3.67 lb.)

**Four Pole
Please contact
Altech.**

Non-standard current ratings available. Minimum quantities may apply. Please contact Altech for further details.

G-Trip Characteristic

Application Examples:
Control transformers, power supplies and reactive loads. Relatively long thermal trip delay and very high magnetic trip point.



One Pole

Rated Current	Type/ Cat. No.
0.5A	1GU05M
1.0A	1GU1M
2.0A	1GU2M
3.0A	1GU3M
4.0A	1GU4M
5.0A	1GU5M
6.0A	1GU6M
8.0A	1GU8M
10A	1GU10M
12A	1GU12M
13A	1GU13M
15A	1GU15M
16A	1GU16M
20A	1GU20M
25A	1GU25M
30A	1GU30M
32A	1GU32M
40A	1GU40M
50A	1GU50M
60A	1GU60M
63A	1GU63M

Standard Pack: 12

Weight:
0.5A - 63A: 1.6kg (3.54 lb.)



Two Pole

Rated Current	Type/ Cat. No.
0.5A	2GU05M
1.0A	2GU1M
2.0A	2GU2M
3.0A	2GU3M
4.0A	2GU4M
5.0A	2GU5M
6.0A	2GU6M
8.0A	2GU8M
10A	2GU10M
12A	2GU12M
13A	2GU13M
15A	2GU15M
16A	2GU16M
20A	2GU20M
25A	2GU25M
30A	2GU30M
32A	2GU32M
40A	2GU40M
50A	2GU50M
60A	2GU60M
63A	2GU63M

Standard Pack: 6

Weight:
0.5A - 63A: 1.6kg (3.54 lb.)



Three Pole

Rated Current	Type/ Cat. No.
0.5A	3GU05M
1.0A	3GU1M
2.0A	3GU2M
3.0A	3GU3M
4.0A	3GU4M
5.0A	3GU5M
6.0A	3GU6M
8.0A	3GU8M
10A	3GU10M
12A	3GU12M
13A	3GU13M
15A	3GU15M
16A	3GU16M
20A	3GU20M
25A	3GU25M
30A	3GU30M
32A	3GU32M
40A	3GU40M
50A	3GU50M
60A	3GU60M
63A	3GU63M

Standard Pack: 4

Weight:
0.5A - 63A: 1.66kg (3.67 lb.)

**Four Pole
Please contact
Altech.**

Non-standard current ratings available. Minimum quantities may apply. Please contact Altech for further details.

M-Series Trip Curves

B, C, G and D Trip Less than 10A

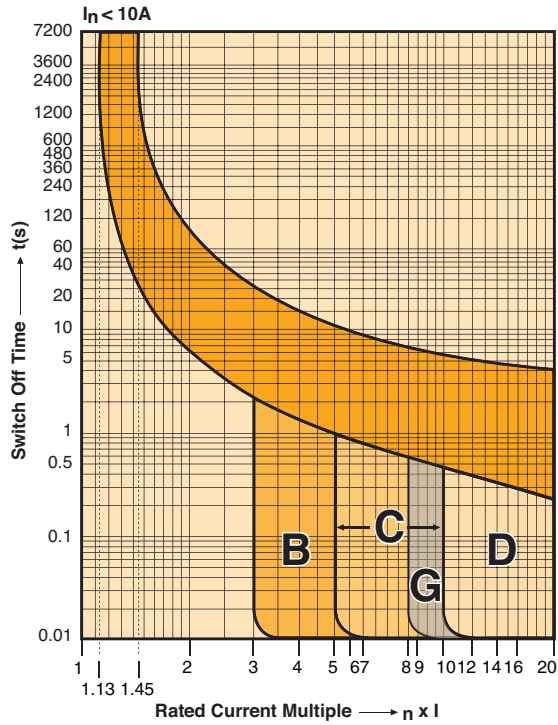

B, C, G and D Trip 10A and higher

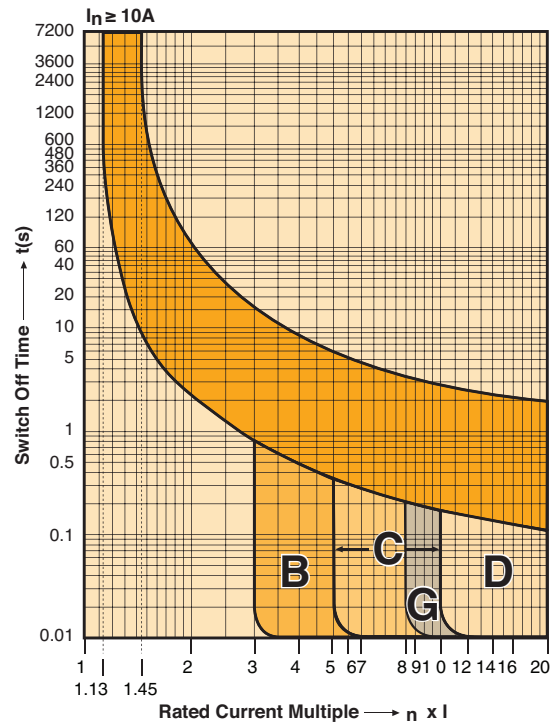

Temperature and Power Loss Specifications

Rated current of MCB	Internal Impedances & Power Loss					MCB Temperature Compensation									
	Internal impedance	Power loss on CB	Maximum allowable impedance of breakdown loop (0.2/0.4s)			Effective rated current allowing for ambient temperature.									
I _n (A)	Z (m Ω)	P (W)	Z _s (Ω)			I _{cor} (A)									
	Char. B,C,D	Char. B,C,D	Char.B	Char.C	Char.D	Ambient Temperature									
						-20°C	-10°C	0°C	10°C	20°C	30°C	40°C	50°C	60°C	
0.50	6600	1.7	42.0	51.1	28.8	0.61	0.59	0.57	0.55	0.53	0.50	0.47	0.44	0.42	
1.00	1650	1.7	46.0	25.6	14.4	1.21	1.18	1.14	1.10	1.05	1.00	0.93	0.88	0.83	
2.00	370	1.5	23.0	12.8	7.2	2.42	2.36	2.28	2.20	2.10	2.00	1.86	1.76	1.67	
3.00	210	1.9	15.3	8.5	4.8	3.63	3.54	3.42	3.30	3.15	3.00	2.79	2.64	2.50	
4.00	126	2.0	11.5	6.4	3.6	4.84	4.72	4.56	4.40	4.20	4.00	3.72	3.52	3.33	
6.00	51	1.8	7.7	4.3	2.4	7.30	7.10	6.80	6.60	6.30	6.00	5.60	5.30	5.00	
8.00	21	1.3	5.8	3.2	1.8	9.70	9.40	9.10	8.80	8.40	8.00	7.40	7.00	6.70	
10.00	14.8	1.5	4.6	2.6	1.4	12.1	11.8	11.40	11.00	10.50	10.00	9.30	8.80	8.30	
13.00	11.3	1.9	3.5	2.0	1.1	15.7	15.3	14.80	14.30	13.70	13.00	12.10	11.50	10.80	
16.00	7.5	1.9	2.9	1.6	0.9	19.4	18.9	18.20	17.60	16.80	16.00	14.90	14.10	13.30	
20.00	6.3	2.5	2.3	1.3	0.7	24.2	23.60	22.80	22.00	21.00	20.00	18.60	17.60	16.70	
25.00	4.4	2.8	1.8	1.0	0.6	30.3	29.50	28.50	27.50	26.30	25.00	23.30	22.00	20.80	
32.00	3.1	3.2	1.4	0.8	0.4	38.7	37.80	36.50	35.20	33.60	32.00	29.80	28.20	26.70	
40.00	2.5	4.0	1.2	0.6	0.4	48.4	47.20	45.60	44.00	42.00	40.00	37.20	35.20	33.30	
50.00	2.2	5.5	0.9	0.5	0.3	60.5	59.0	57.00	55.00	52.50	50.00	46.50	44.10	41.70	
63.00	1.6	6.4	0.7	0.4	0.2	76.2	74.30	71.80	69.30	66.20	63.00	58.60	55.50	52.50	

Introduction

UL 489

UL 508

UL 1077

Busbars

ANNEX

Accessories

M-Series - UL508 Manual Motor Controller with Disconnecting Mean



Accessories can be factory or field mounted on M-Series manual motor controllers for enhanced control and monitoring capabilities. Field mounting kits include all necessary parts and instructions. Accessories can be gang mounted on a single controller (the Auxiliary Switch in the outside position). The mounting arrangement links the internal latch-pins for the tripping mechanisms, ensuring simultaneous trips. Handles are linked to simplify manual resetting.



Neutral Pole (63A/480Y/277 VAC)

Description	Type/ Cat. No.	Cable Max	Cable Min	Torque Max	Torque Min
Neutral	ALTN2	25mm ² AWG 3	2.5mm ² AWG 12	2Nm 17.5 lb-in	1.5Nm 12 lb-in

Standard Pack: 10

Weight: 1.25kg (2.77 lb.)



Shunt Trip



Undervoltage Trip

Shunt Trip and Undervoltage Trip **

Description	Shunt Trip Type/Cat. No.	Operational Voltage	Rated Coil Current	Undervoltage Trip* Type/Cat. No.
AC Coil:				
12V AC	FA12ACR	8.4 - 13.2V	6A	UV12ACR
24V AC	FA24ACR	16.8 - 26.4V	2.8A	UV24ACR
48V AC	FA48ACR	33.6 - 52.8V	0.8A	UV48ACR
60V AC	FA60ACR	42 - 66V	~0.7A	UV60ACR
110V AC	FA110ACR	77 - 121V	0.5A	UV110ACR
120V AC	FA120ACR	84 - 132V	~0.5A	UV120ACR
230V AC	FA230ACR	161 - 253V	0.6A	UV230ACR
277V AC	FA277ACR	194 - 305V	~0.5A	UV277ACR
400V AC	FA400ACR	280 - 440V	0.5A	UV400ACR
DC Coil:				
12V DC	FA12DCR	8.4 - 13.2V	~6A	UV12DCR
24V DC	FA24DCR	16.8 - 26.4V	3A	UV24DCR
48V DC	FA48DCR	33.6 - 52.8V	2A	UV48DCR
110V DC	FA110DCR	77 - 121V	0.6A	UV110DCR

* Reset-Hold Voltage = $0.85 \times V_E$; Drop-Out Voltage = $0.2 \times V_E$

** Special order in conjunction with circuit breaker that is factory assembled (not field assembled).

Standard Pack: 10

Weight: 1.1kg (2.43 lb.)

Terminal Size - min/max	2.5 mm ² (12 AWG) / 25mm ² (3 AWG)
Terminal Torque - min/max	1.5 Nm (12 lb. in.) / 2 Nm (17.5 lb. in.)

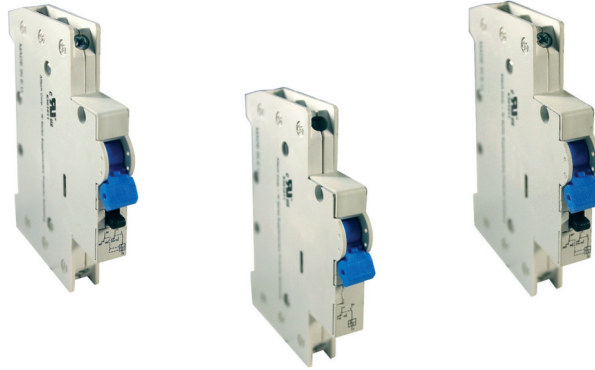

Auxiliary Contact (4A/230 VAC)

Description	Type/ Cat. No.	Cable Max	Cable Min	Torque Max	Torque Min
1 x CO	H1COR	2.5mm ² AWG 12	0.5mm ² AWG 20	0.5Nm 4 lb-in	0.33Nm 3 lb-in
2 x CO	H2COR				
1 x CO, 1 Signal & Test Button	HSTCOR				

Standard Pack: 15

Weight: H1COR: 0.5kg (1.32 lb.); H2COR, HSTCOR: 0.72kg (1.59 lb.)

Wiring Diagram

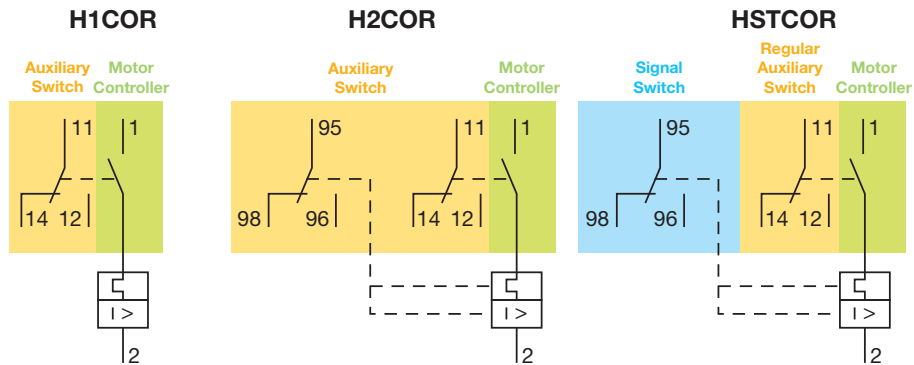

Lock-out Adapter Luggage Lock

Description	Type/ Cat. No.
Yellow	EASS2

Standard Pack: 10

Weight: 50g (1.76 oz.)