

FEATURES

- High Reliability LPE GaAlAs IRLEDs
- Ultra-High-Power Output
- 880 nm Peak Emission
- Six Chips Connected in Series
- Very Wide Angle of Emission
- Electrically Isolated Case

Electro-Optical Characteristics at 25°C

Parameters	Test Conditions	Min	Typ	Max	Units
Total Power Output, P_o	$I_F = 300 \text{ mA}$ $I_F = 6 \text{ A}$	300	330 5000		mW
Peak Emission Wavelength, λ_p	$I_F = 50 \text{ mA}$		880		nm
Spectral Bandwidth at 50%, $\Delta\lambda$	$I_F = 50 \text{ mA}$		80		nm
Half Intensity Beam Angle, θ	$I_F = 50 \text{ mA}$		120		Deg
Forward Voltage, V_F	$I_F = 300 \text{ mA}$		9	10	Volts
Reverse Breakdown Voltage, V_R	$I_R = 10 \mu\text{A}$	5	30		Volts
Capacitance, C	$V_R = 0 \text{ V}$		15		pF
Rise Time			2		μsec
Fall Time			2		μsec

Absolute Maximum Ratings at 25°C Case

Parameters	Units
Power Dissipation ¹	4 W
Continuous Forward Current	400 mA
Peak Forward Current (10 μs , 400 Hz) ²	6 A
Reverse Voltage	5 V
Lead Soldering Temperature (1/16" from case for 10 sec)	260°C

¹ Derate per thermal derating curve above 25°C.

² Derate linearly above 25°C.

Thermal Parameters

Parameters	Units
Storage and Operating Temperature Range	-55°C to 100°C
Maximum Junction Temperature	100°C
Thermal Resistance, R_{THJA} ¹	60°C/W Typical
Thermal Resistance, R_{THJA} ²	16°C/W Typical

¹ Heat transfer minimized by measuring in still air with minimum heat conducting through leads.

² Air circulating at a rapid rate to keep case temperature at 25°C.

Maximum Rated Thermal Derating Curve

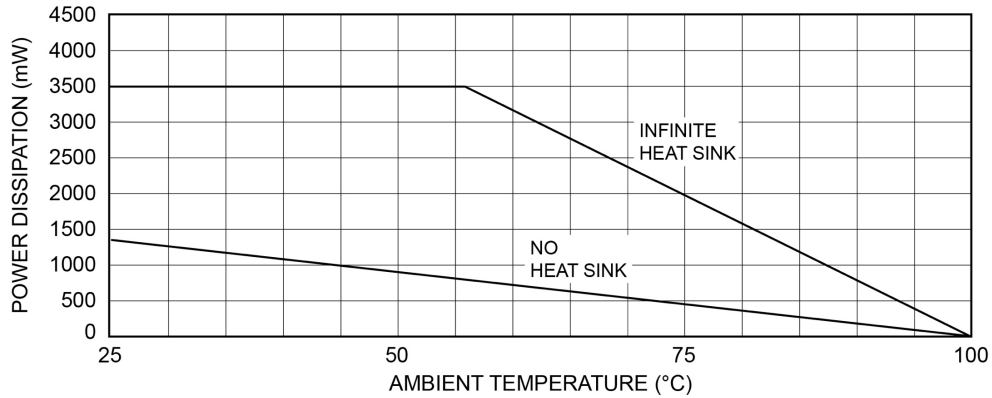

Maximum Rated Peak Pulse Current

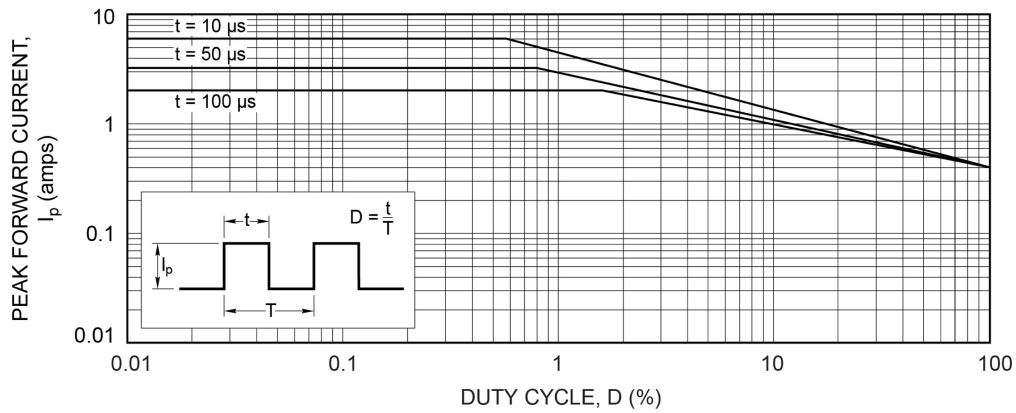

Typical Degradation Curve

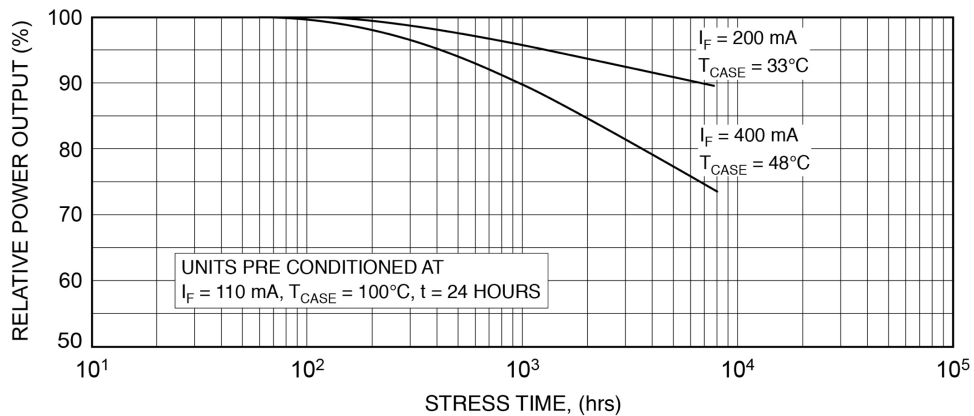

Typical Radiation Pattern

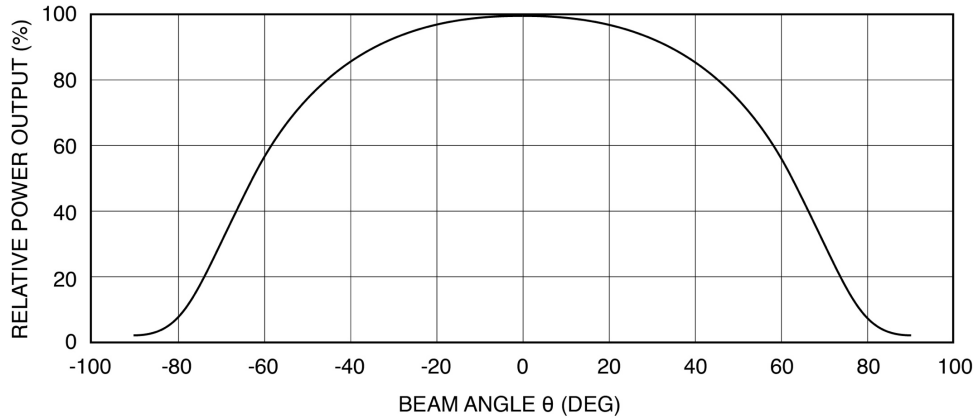

Typical Forward I-V Characteristics

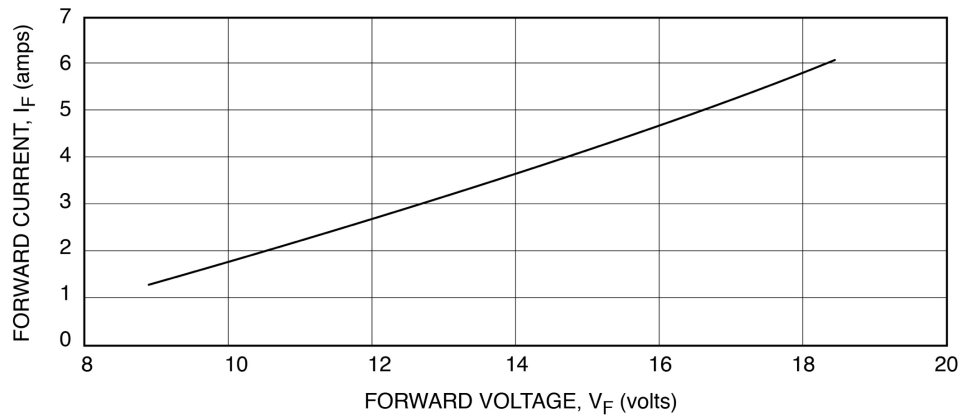

Typical Power Output vs Temperature

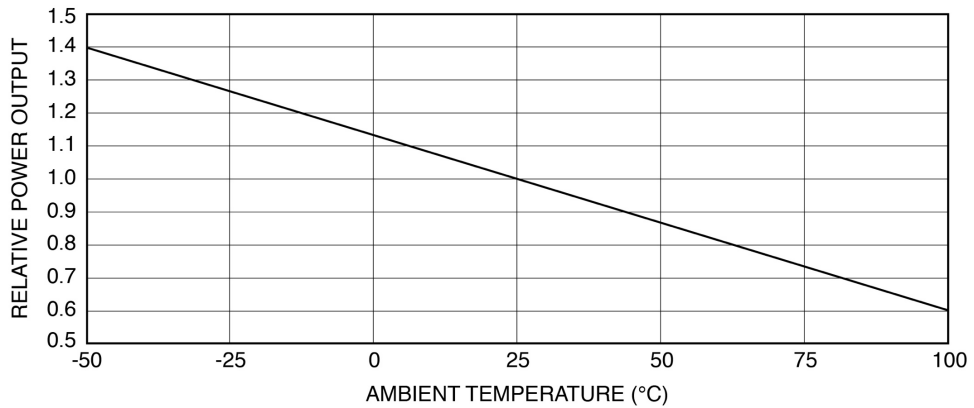

Typical Spectral Output

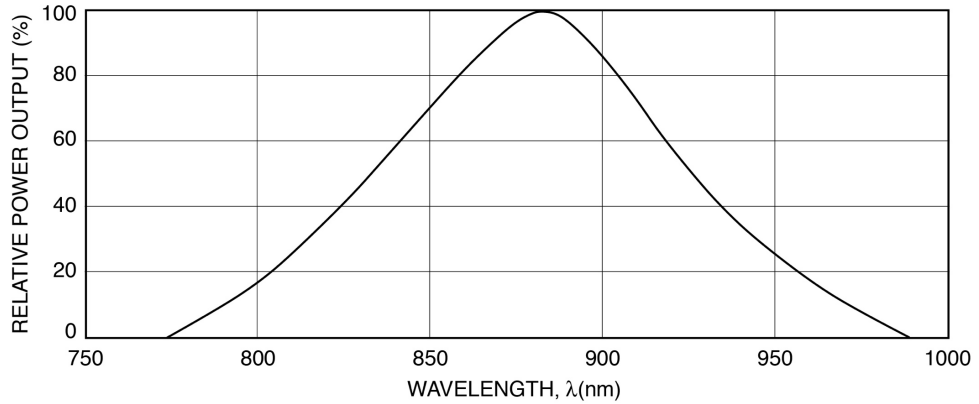

Typical Power Output vs Forward Current

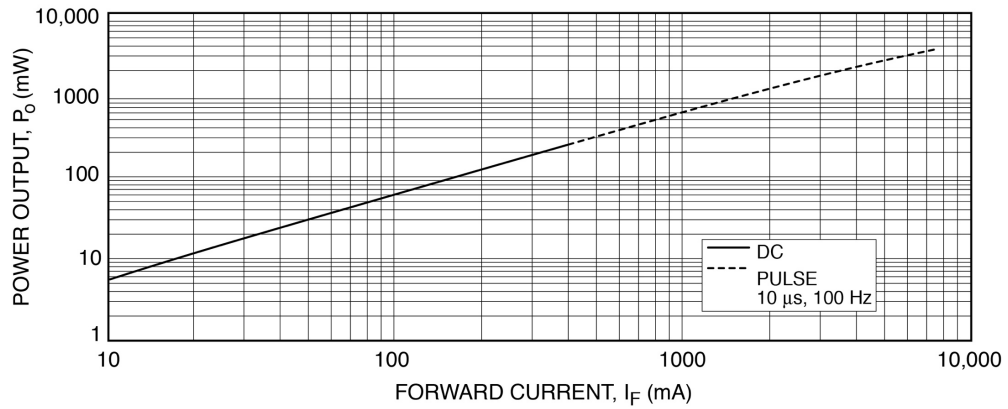

Package Information

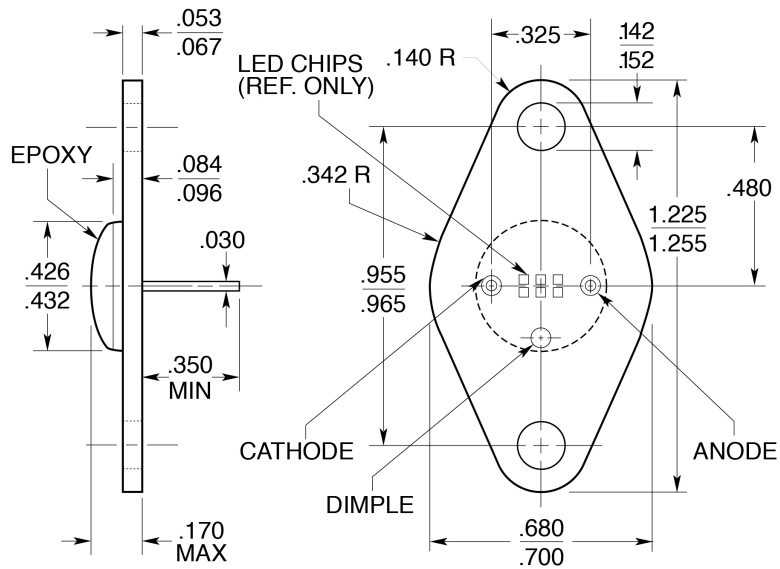

All surfaces are gold plated. Dimensions are nominal values in inches unless otherwise specified.

Specifications are subject to change without prior notice.