

TL0374J: 0.6 – 3.0 GHz Ultra Low Noise Amplifier

1.0 Features

- Small signal gain @ 1800MHz: 21.5dB
- NF @ 1800MHz: 0.35dB
- P1dB @ 1800MHz: 18.5dBm
- 5V Typical operating voltage
- Operating frequency: 0.6 to 3.0GHz



Figure 1.1 Device Image
(8 Pin 2x2x0.75mm QFN Package)

2.0 Applications

- 4G/5G Infrastructure Radios
- Small Cells and Cellular Repeaters
- Phase Array Radar
- SDARS



RoHS/REACH/Halogen Free Compliance

3.0 Description

The TL0374J is a broadband, ultra-low Noise Amplifier (LNA) providing high gain and linearity. With a simple input and output match, this LNA can be tuned for different frequency bands targeting LTE (small cells and infrastructure) and any other applications requiring low noise, high gain, and linearity. For >3GHz frequency band, TL0375J can be considered.

The TL0374J is packaged in a compact, low cost Dual Flat No Lead (DFN) 2x2x0.75mm, 8 pin plastic package.

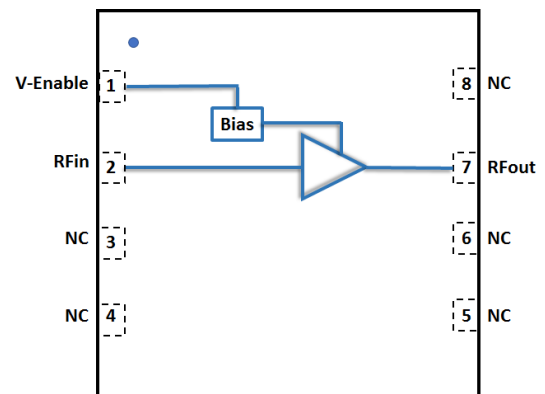

Figure 3.1 Function Block Diagram
(Top View)

4.0 Ordering Information

Table 4.1 Ordering Information

Base Part Number	Package Type	Form	Qty	Reel Diameter	Reel Width	Orderable Part Number
TL0374J	8 Pin 2x2x0.75mm DFN	Tape and Reel	3000	13" (330mm)	18mm	TL0374JMTRPBF
Tuned Evaluation Board, 1800 - 2100MHz						TL0374J-EVB-A
Tuned Evaluation Board, 2500 - 2700MHz						TL0374J-EVB-B

5.0 Pin Description

Table 5.1 Pin Definition

Pin Number	Pin Name	Description
3-6, 8	NC	No internal connection, can be connected to ground
1	Venable	Venable along with series resistor, sets the Idq. Venable <0.2V disables the device
2	RF _{IN}	RF Input. DC blocking cap required
7	RF _{OUT} /V _{dd}	RF Output. Vdd supplied through an external choke inductor
Package Base	Paddle/Slug	DC and RF Ground. Also provides thermal relief. Multiple vias are recommended

Note: [1] The backside ground slug of the device must be grounded directly to the ground plane through multiple vias to ensure proper operation. Adequate heatsinking required.

6.0 Absolute Maximum Rating

Table 6.1 Absolute Maximum Rating @T_A=+25°C Unless Otherwise Specified

Parameter	Symbol	Value	Unit
Electrical Ratings			
Supply voltage, Venable	V _{dd}	+6	V
Drain current	I _{DQ}	70	mA
RF input power CW	RF _{IN}	23	dBm
Storage Temperature Range	T _{st}	-55 to +150	°C
Operating Temperature Range	T _{op}	-40 to +105	°C
Maximum Junction Temperature	T _J	170	°C
Thermal Ratings			
Thermal Resistance (junction-to-case) – Bottom side	R _{θJC}	15.0	°C/W
Soldering Temperature	T _{SOLD}	260	°C
ESD Ratings			
Human Body Model (HBM)	Level 1B	500 to <1000	V
Charged Device Model (CDM)	Level C	≥1000	V
Moisture Rating			
Moisture Sensitivity Level	MSL	1	-

Attention:

Maximum ratings are absolute ratings. Exposure to absolute maximum rating conditions for extended periods may affect device reliability. Exceeding one or a combination of the absolute maximum ratings may cause permanent and irreversible damage to the device and/or to surrounding circuit.

7.0 Recommended DC Operating Conditions

Table 7.1 Recommended Operating Conditions

Parameter	Symbol	Minimum	Typical	Maximum	Unit
Drain Voltage	V_{DD}		+5.0		V
Venable Voltage	V_{enable}		+5.0		V
Drain Bias Current	I_{DQ} , Set by external resistor	45	60		mA
Venable Bias Current	I_{bias}		3.0		mA
Operating Temperature Range		-40	+25	+105	°C

8.0 RF Electrical Specifications for 1800 - 2100MHz and 2500 - 2700MHz EVB

Table 8.1 1800 – 2100MHz EVB @ $T_A=+25^{\circ}C$ Unless Otherwise Specified; Venable = High

Parameter	Test Condition	Minimum	Typical	Maximum	Unit
Gain	Across the band		20-21.5		dB
Noise Figure	Across the band		0.35- 0.4		dB
EVB Noise Figure	Across the band		0.4- 0.45		dB
Input Return Loss	Across the band		17-27		dB
Output Return Loss	Across the band		8.5-10		dB
OP1dB	Across the band		18-19.5		dBm
OIP3	Across the band, 0dBm per tone, Tone Spacing 1MHz		35-37.5		dBm
Switching Rise Time	10/90% of the RF value		300		nsec
Switching Fall Time	10/90% of the RF value		350		nsec

Table 8.2 2500 – 2700MHz EVB @ $T_A=+25^{\circ}C$ Unless Otherwise Specified; Venable = High

Parameter	Test Condition	Minimum	Typical	Maximum	Unit
Gain	2600MHz	18	19		dB
Noise Figure	2600MHz		0.37	0.47	dB
EVB Noise Figure	2600MHz		0.45	0.55	dB
Input Return Loss	2600MHz		-28		dB
Output Return Loss	2600MHz		-9		dB
OP1dB	2600MHz		19.5		dBm
OIP3	2600MHz, 0dBm per tone, Tone Spacing 1MHz	33.5	36.5		dBm
Switching Rise Time	10/90% of the RF value		300		nsec
Switching Fall Time	10/90% of the RF value		350		nsec

9.0 Typical Characteristics

9.1 2500 - 2700MHz tuned EVB (V_{DD}=5V, I_{DQ}=60mA), -40°C, 25°C, 85°C, 105 °C, Narrowband

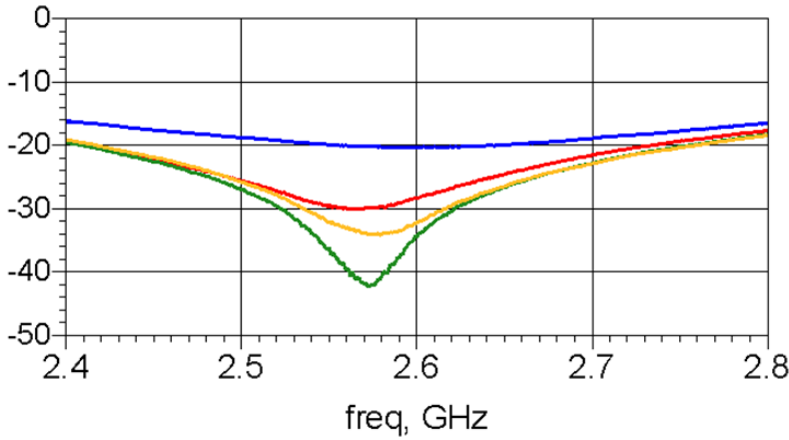

Figure 9.1 S11 (IRL) vs Freq

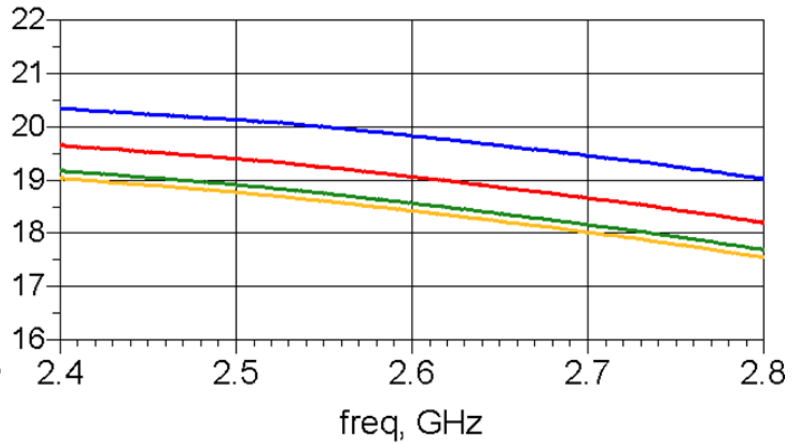

Figure 9.2 S21 (Gain) vs Freq

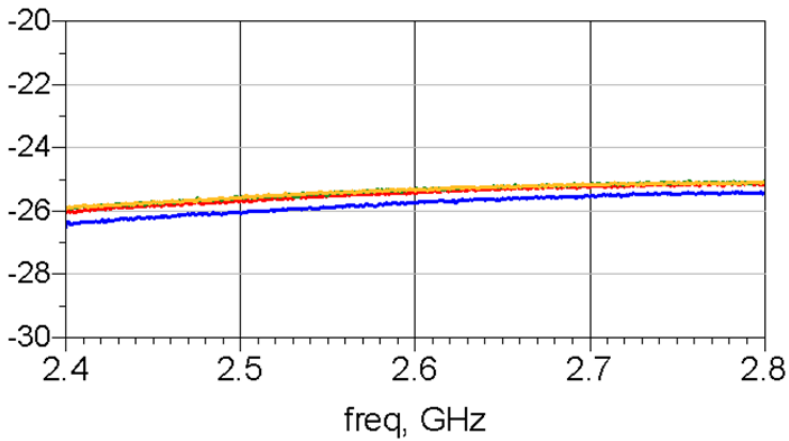

Figure 9.3 S12 (Rev Iso) vs Freq

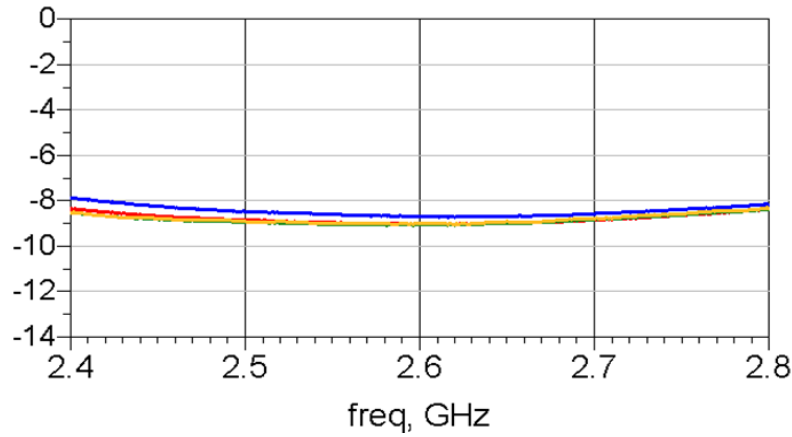

Figure 9.4 S22 (ORL) vs Freq

9.2 2500 - 2700MHz tuned EVB (V_{DD}=5V, I_{DQ}=60mA), -40°C, 25°C, 85°C, 105 °C, Broadband

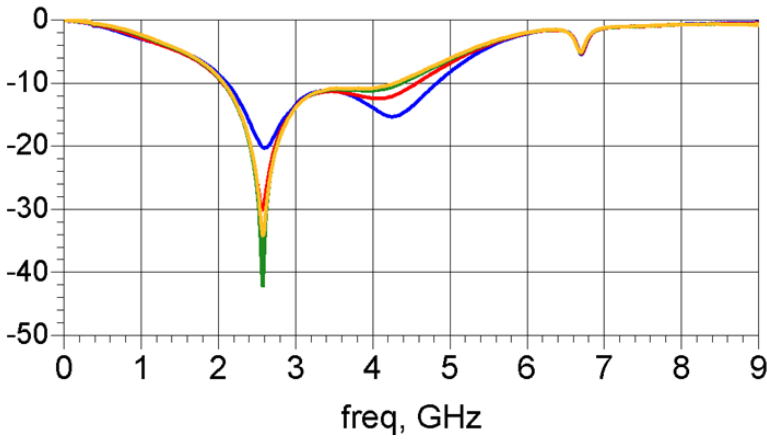

Figure 9.5 S11 (IRL) vs Freq

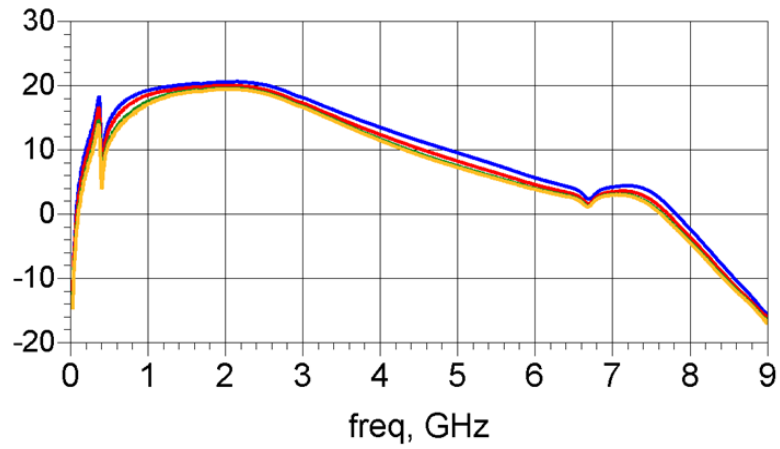

Figure 9.6 S21 (Gain) vs Freq

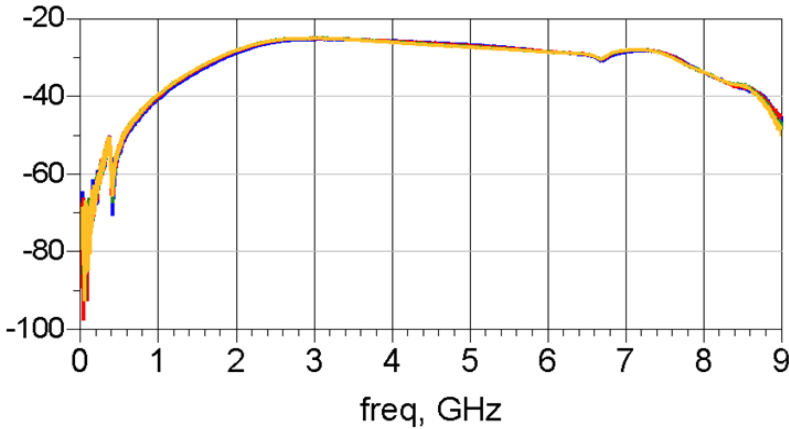

Figure 9.7 S12 (Rev Iso) vs Freq

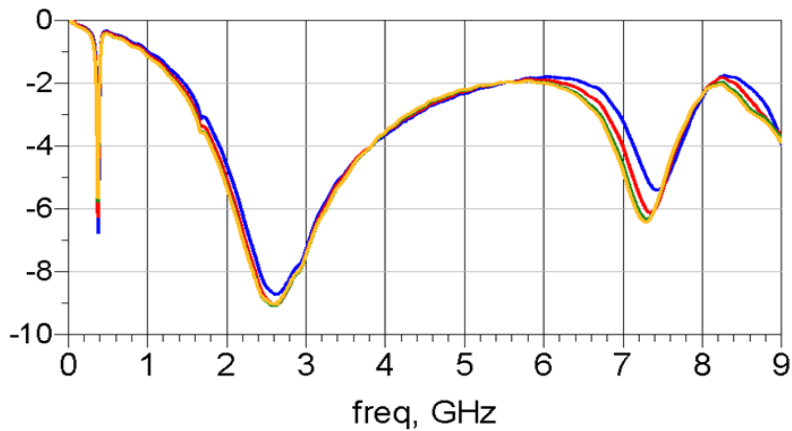

Figure 9.8 S22 (ORL) vs Freq

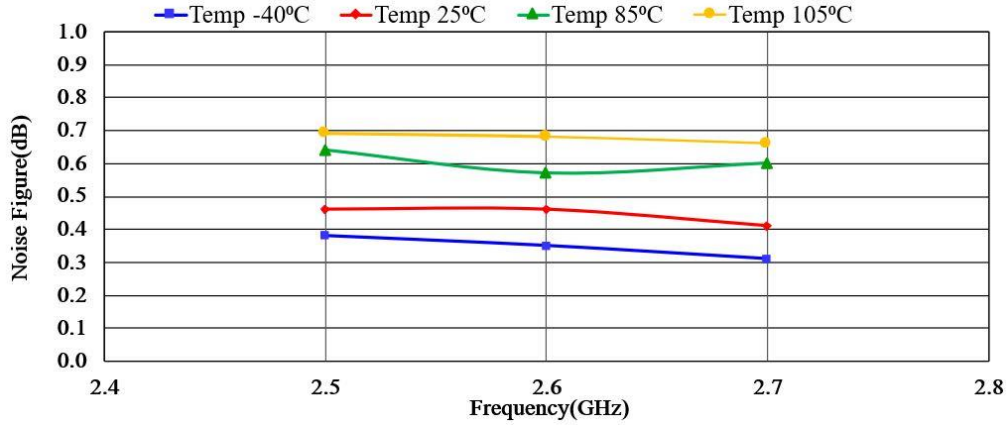

Figure 9.9 Noise Figure (EVB) vs Freq

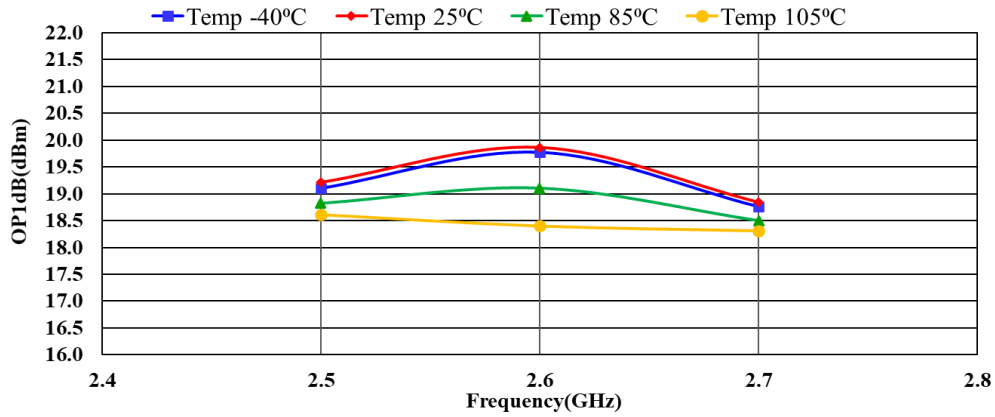

Figure 9.10 Output P1dB vs Freq

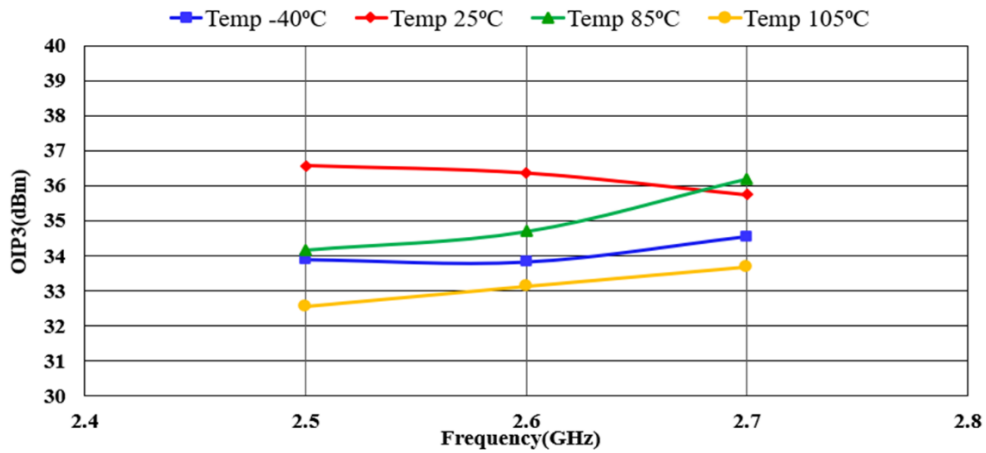

Figure 9.11 Output IP3 vs Freq

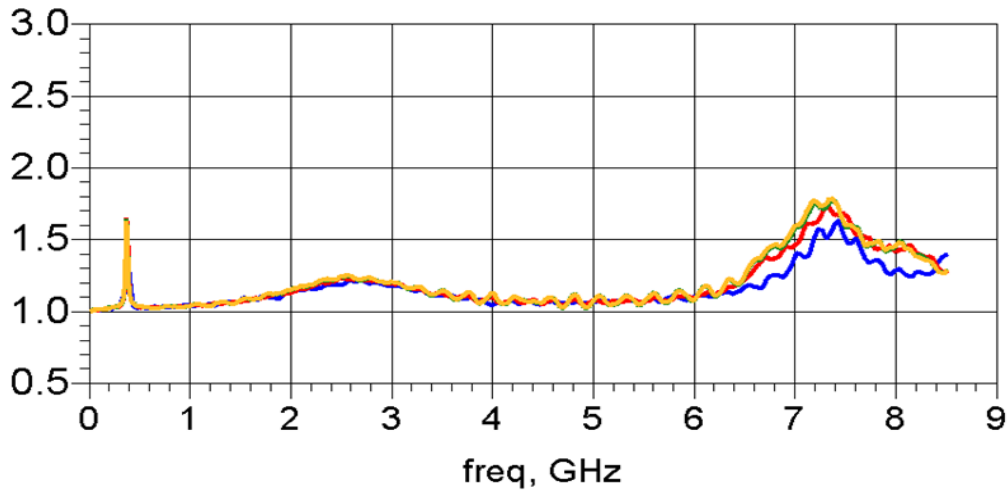

Figure 9.12 Mu1 vs Freq

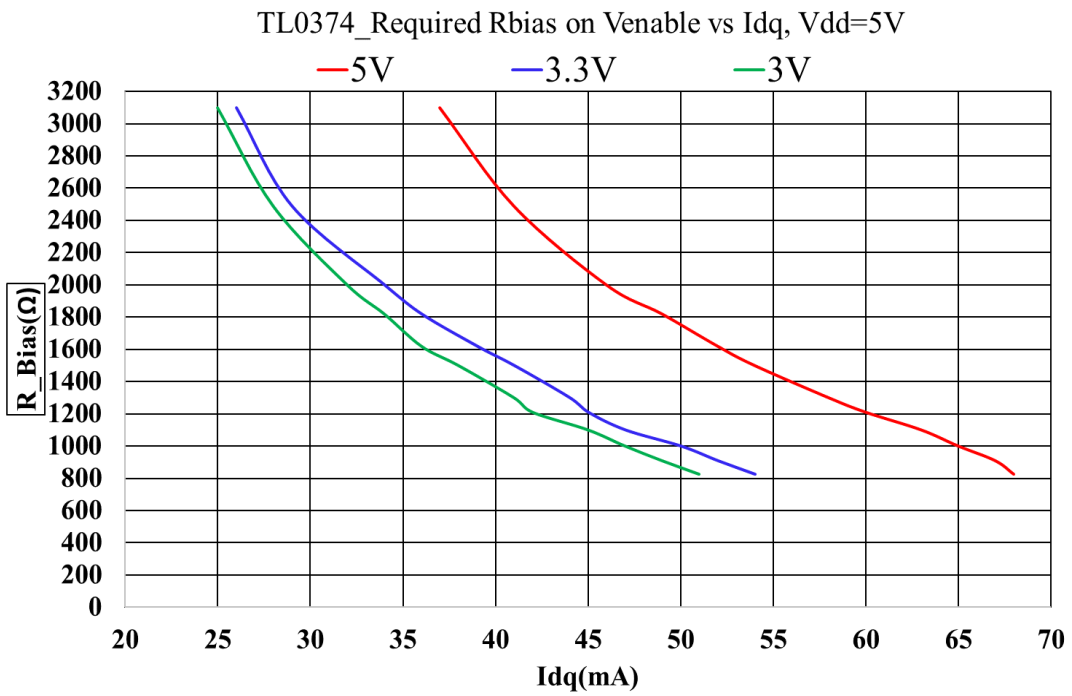

Figure 9.13 Rbias on Venable vs Idq

10.0 Evaluation Boards

10.1 1800 - 2100MHz EVB

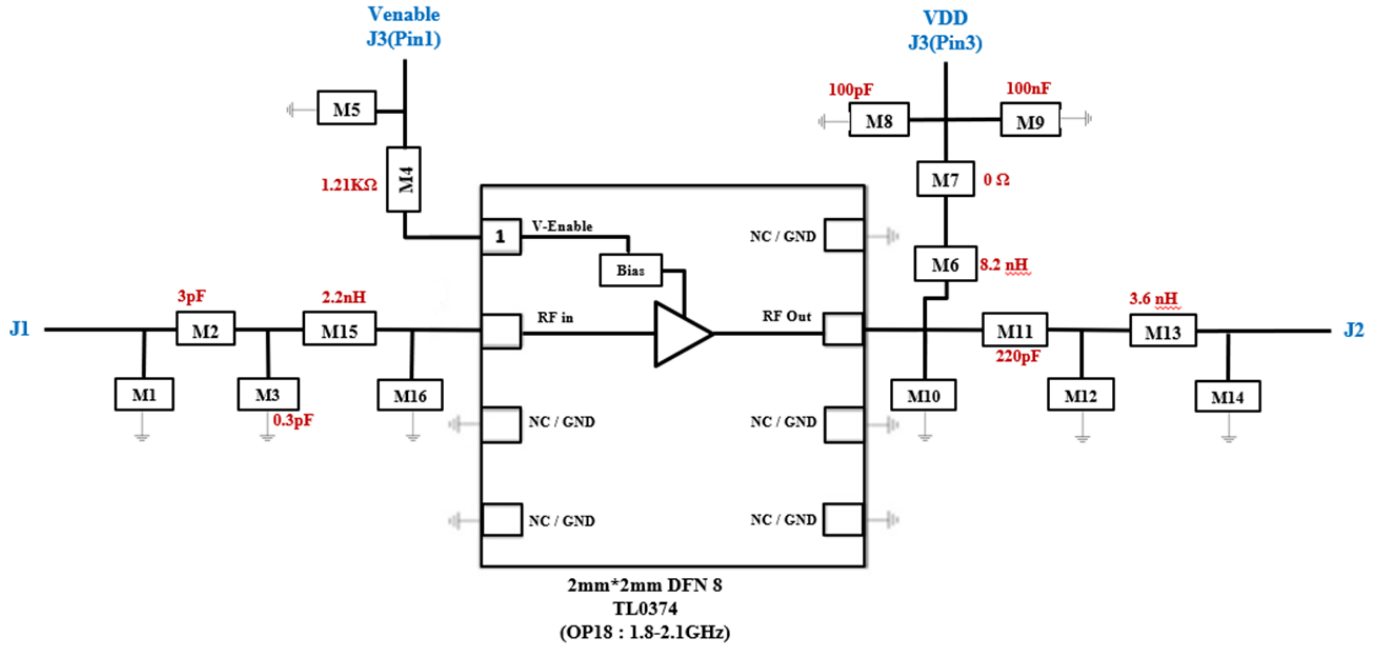

Figure 10.1 Schematic of the 1800 - 2100MHz EVB

Table 10.1 BOM of the 1800 - 2100MHz EVB

Component ID	Value	Manufacturer	Recommended Part Number
M2	3.0pF	Murata	GJM1555C1H3R0BB01
M3	0.3pF	Murata	GJM1555C1HR30BB01
M15	2.2nH	Coilcraft	0402HP-2N2XJE
M4	1.21KΩ	Panasonic	ERJ-2RKF1211X
M8	100pF	AVX	04025A101JAT4A
M9	100nF	TDK	C1005X7R1H104K050BE
M7	0Ω	Panasonic	ERJ-2GE0R00X
M6	8.2nH	Coilcraft	0402HP-8N2XGE
M11	220pF	Kemet	C0402C221K5GACAUTO
M13	3.6nH	Coilcraft	0402HP-3N6XGE
PCB	Rogers RO4350B, 20 mils, 1 oz copper		

10.2 2500 - 2700MHz EVB

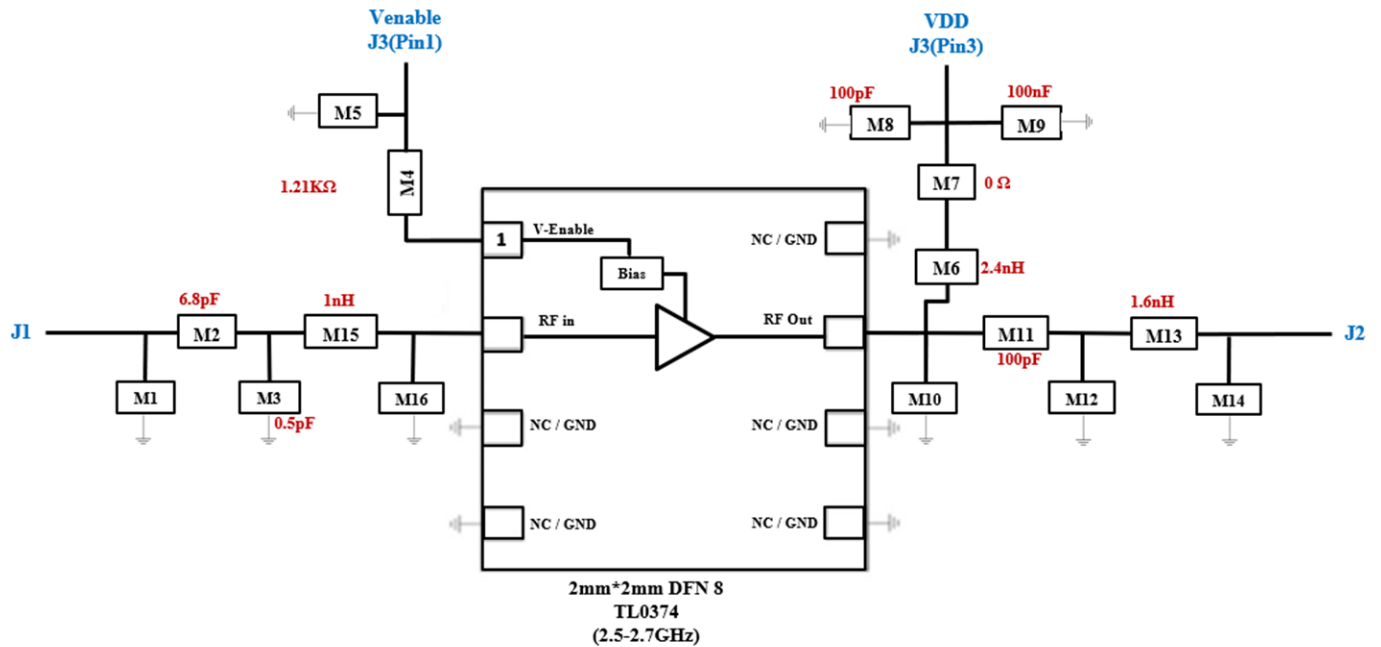

Figure 10.2 Schematic of the 2500 - 2700MHz EVB

Table 10.2 BOM for 2500 - 2700MHz EVB

Component ID	Value	Manufacturer	Recommended Part Number
M1	6.8pF	Murata	GJM1555C1H6R8BB01
M3	0.5pF	Murata	GJM1555C1HR50BB01
M15	1nH	Coilcraft	0402HP-1N0XJE
M4	1.21KΩ	Panasonic	ERJ-2RKF1211X
M8	100pF	AVX	04025A101JAT4A
M9	100nF	TDK	C1005X7R1H104K050BE
M7	0Ω	Panasonic	ERJ-2GE0R00X
M6	2.4nH	Coilcraft	0402HP-2N4XGE
M11	100pF	AVX	04025A101JAT4A
M13	1.6nH	Coilcraft	0603HC-1N6XGLW
PCB	Rogers RO4350B, 20 mils, 1 oz copper		

11.0 Device Package Information

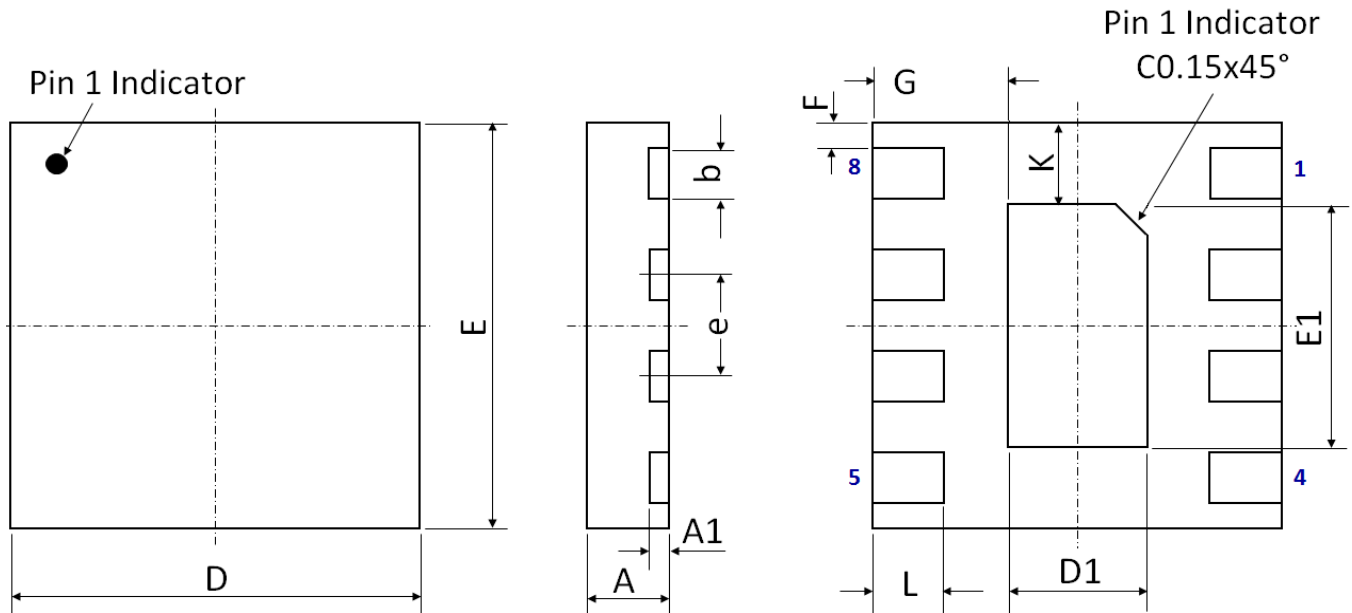

Figure 11.1 Device Package Drawing
(All dimensions are in mm)

Table 11.1 Device Package Dimensions

Dimension (mm)	Value (mm)	Tolerance (mm)	Dimension (mm)	Value (mm)	Tolerance (mm)
A	0.75	±0.05	E	2.00 BSC	±0.05
A1	0.203	±0.02	E1	1.20	±0.05
b	0.25	±0.02	F	0.125	±0.02
D	2.00 BSC	±0.05	G	0.66	±0.03
D1	0.68	±0.03	L	0.35	±0.05
e	0.50 BSC	±0.05	K	0.40	±0.05

Note: Lead finish: Pure Sn without underlayer; Thickness: 7.5µm ~ 20µm (Typical 10µm ~ 12µm)

Attention:

Please refer to application notes *TN-001* and *TN-002* at <http://www.tagoretech.com> for PCB and soldering related guidelines.

12.0 PCB Land Design

Guidelines:

- [1] 2-layer PCB is recommended
- [2] Via diameter is recommended to be 0.3mm to prevent solder wicking inside the vias
- [3] Thermal vias shall only be placed on the center pad and should be filled/plugged with solder or copper
- [4] The maximum via number for the center pad is $1(X) \times 2(Y) = 2$

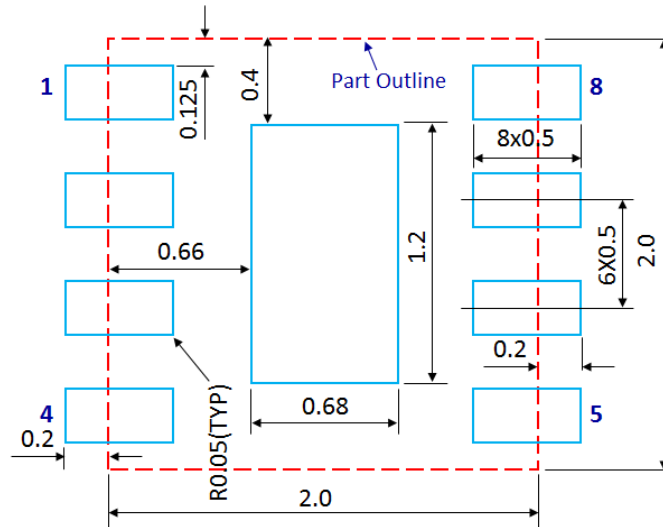

Figure 12.1 PCB Land Pattern
(Dimensions are in mm)

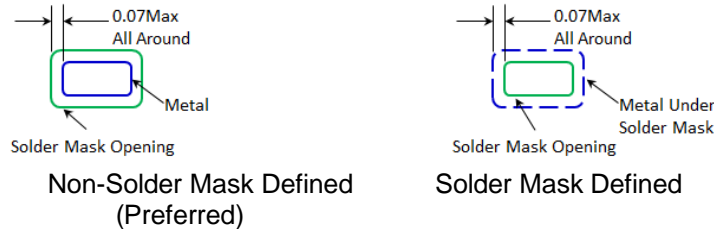

Figure 12.2 Solder Mask Pattern
(Dimensions are in mm)

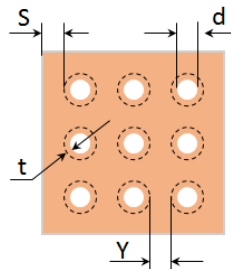

Figure 12.3 Thermal Via Pattern
(Recommended Values: $S \geq 0.15\text{mm}$; $Y \geq 0.20\text{mm}$; $d = 0.3\text{mm}$; Plating Thickness $t = 25\mu\text{m}$ or $50\mu\text{m}$)

13.0 PCB Stencil Design

Guidelines:

[1] Laser-cut, stainless steel stencil is recommended with electro-polished trapezoidal walls to improve the paste release.

[2] Stencil thickness is recommended to be 125µm.

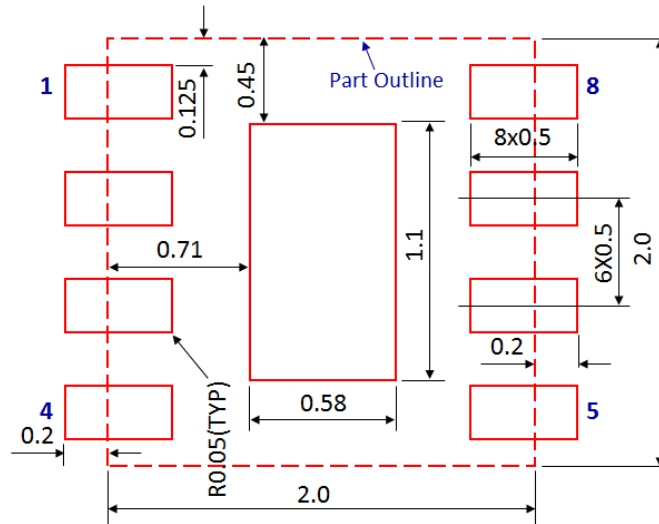

Figure 13.1 Stencil Openings
(Dimensions are in mm)

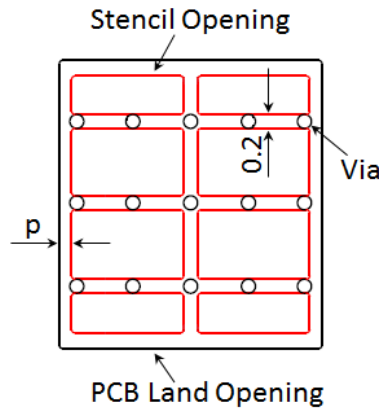

Figure 13.2 Stencil Openings Shall not Cover Via Areas If Possible
(Dimensions are in mm)

14.0 Tape and Reel Information

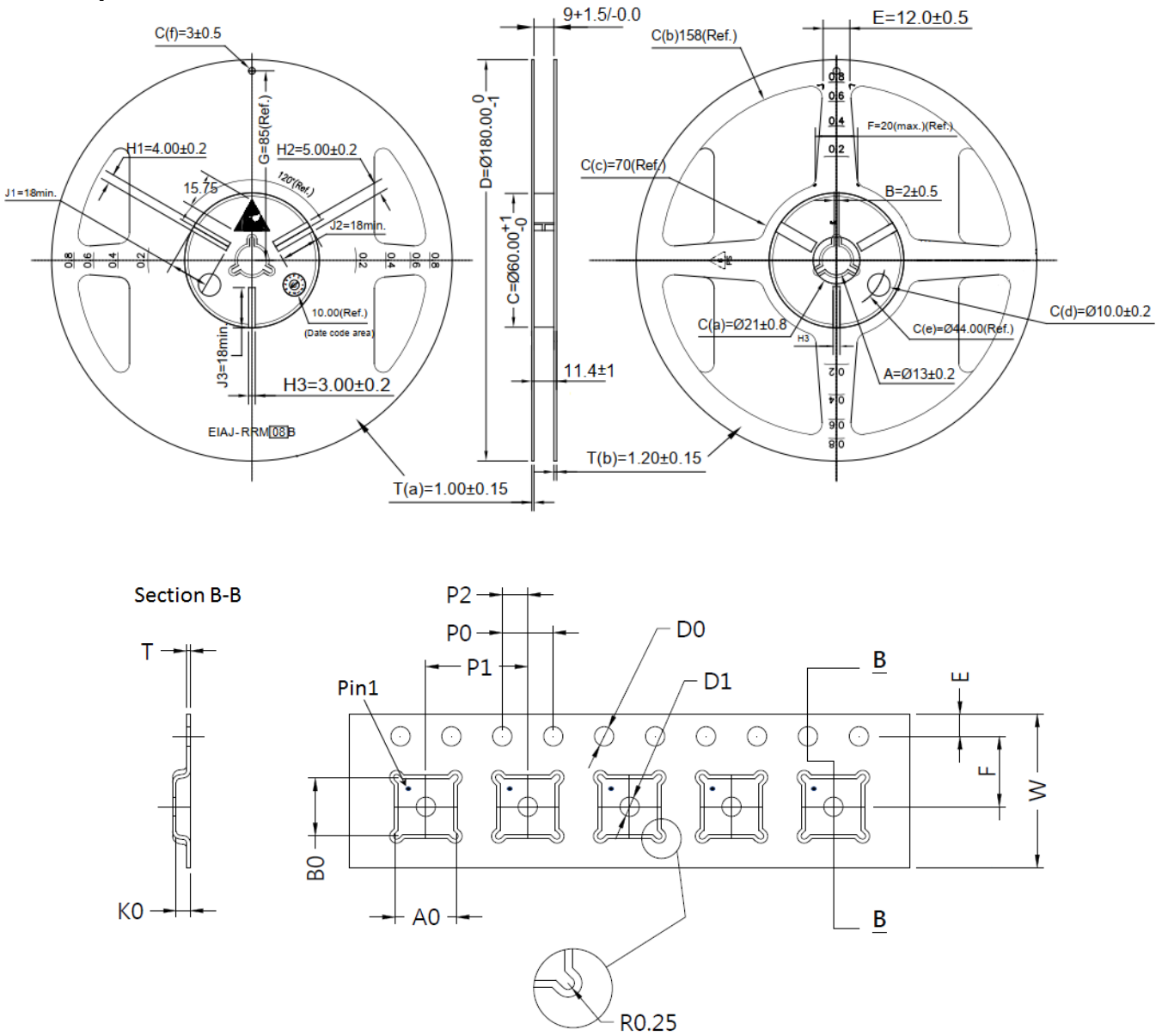

Figure 14.1 Tape and Reel Drawing

Table 14.1 Tape and Reel Dimensions

Dimension (mm)	Value (mm)	Tolerance (mm)	Dimension (mm)	Value (mm)	Tolerance (mm)
A0	2.35	±0.10	K0	1.10	±0.10
B0	2.35	±0.10	P0	4.00	±0.10
D0	1.50	+0.10/-0.00	P1	8.00	±0.10
D1	1.50	+0.10/-0.00	P2	2.00	±0.05
E	1.75	±0.10	T	0.30	±0.05
F	5.50	±0.05	W	12.00	±0.30

Edition Revision 1.3 - 2021-03-09

Published by

Tagore Technology Inc.
5 East College Drive, Suite 200
Arlington Heights, IL 60004, USA

©2020 All Rights Reserved

Legal Disclaimer

The information provided in this document shall in no event be regarded as a guarantee of conditions or characteristics. Tagore Technology assumes no responsibility for the consequences of the use of this information, nor for any infringement of patents or of other rights of third parties which may result from the use of this information. No license is granted by implication or otherwise under any patent or patent rights of Tagore Technology. The specifications mentioned in this document are subject to change without notice.

Information

For further information on technology, delivery terms and conditions and prices, please contact Tagore Technology: support@tagoretech.com.