



NDH8302P Dual P-Channel Enhancement Mode Field Effect Transistor

General Description

These P-Channel enhancement mode power field effect transistors are produced using Fairchild's proprietary, high cell density, DMOS technology. This very high density process is especially tailored to minimize on-state resistance. These devices are particularly suited for low voltage applications such as notebook computer power management and other battery powered circuits where fast high-side switching, and low in-line power loss are needed in a very small outline surface mount package.

Features

- -2 A, -20 V. $R_{DS(ON)} = 0.13 \Omega @ V_{GS} = -4.5 V$
 $R_{DS(ON)} = 0.19 \Omega @ V_{GS} = -2.7 V.$
- Proprietary SuperSOT™-8 package design using copper lead frame for superior thermal and electrical capabilities.
- High density cell design for extremely low $R_{DS(ON)}$.
- Exceptional on-resistance and maximum DC current capability.

2

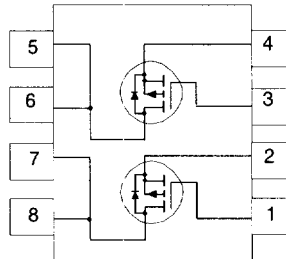
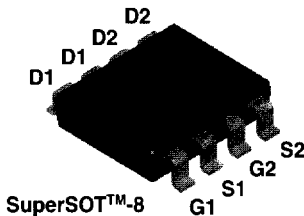

Absolute Maximum Ratings $T_A = 25^\circ C$ unless otherwise noted

Symbol	Parameter	NDH8302P	Units
V_{DS}	Drain-Source Voltage	-20	V
V_{GS}	Gate-Source Voltage	± 8	V
I_D	Drain Current - Continuous	-2	A
	- Pulsed	-10	
P_D	Maximum Power Dissipation	0.8	W
T_J, T_{STG}	Operating and Storage Temperature Range	-55 to 150	$^\circ C$

THERMAL CHARACTERISTICS

$R_{\theta JA}$	Thermal Resistance, Junction-to-Ambient	(Note 1)	156	$^\circ C/W$
$R_{\theta JC}$	Thermal Resistance, Junction-to-Case	(Note 1)	40	$^\circ C/W$

ELECTRICAL CHARACTERISTICS (T _A = 25°C unless otherwise noted)						
Symbol	Parameter	Conditions	Min	Typ	Max	Units
OFF CHARACTERISTICS						
BV _{DS}	Drain-Source Breakdown Voltage	V _{GS} = 0 V, I _D = -250 μA	-20			V
I _{DSS}	Zero Gate Voltage Drain Current	V _{DS} = -16 V, V _{GS} = 0 V			-1	μA
		T _J = 55°C			-10	μA
I _{GSSF}	Gate - Body Leakage, Forward	V _{GS} = 8 V, V _{DS} = 0 V			100	nA
I _{GSSR}	Gate - Body Leakage, Reverse	V _{GS} = -8 V, V _{DS} = 0 V			-100	nA
ON CHARACTERISTICS (Note 2)						
V _{GS(th)}	Gate Threshold Voltage	V _{DS} = V _{GS} , I _D = -250 μA	-0.4	-0.6	-1	V
		T _J = 125°C	-0.3	-0.42	-0.8	
R _{DS(on)}	Static Drain-Source On-Resistance	V _{GS} = -4.5 V, I _D = -2 A		0.102	0.13	Ω
		T _J = 125°C		0.15	0.23	
		V _{GS} = -2.7 V, I _D = -1.7 A		0.147	0.19	
I _{D(on)}	On-State Drain Current	V _{GS} = -4.5 V, V _{DS} = -5 V	-10			A
		V _{GS} = -2.7 V, V _{DS} = -5 V	-4			
g _{FS}	Forward Transconductance	V _{DS} = -5 V, I _D = -2 A		5		S
DYNAMIC CHARACTERISTICS						
C _{iss}	Input Capacitance	V _{DS} = -10 V, V _{GS} = 0 V,		515		pF
C _{oss}	Output Capacitance	f = 1.0 MHz		250		pF
C _{rss}	Reverse Transfer Capacitance			85		pF
SWITCHING CHARACTERISTICS (Note 2)						
t _{D(on)}	Turn - On Delay Time	V _{DD} = -5 V, I _D = -1 A,		10	20	ns
t _r	Turn - On Rise Time	V _{GS} = -4.5 V, R _{GEN} = 6 Ω		27	50	ns
t _{D(off)}	Turn - Off Delay Time			37	65	ns
t _f	Turn - Off Fall Time			39	75	ns
Q _g	Total Gate Charge	V _{DS} = -10 V,		7.8	11	nC
Q _{gs}	Gate-Source Charge	I _D = -2 A, V _{GS} = -4.5 V		1.2		nC
Q _{gd}	Gate-Drain Charge			1.8		nC

ELECTRICAL CHARACTERISTICS (T_A = 25°C unless otherwise noted)

Symbol	Parameter	Conditions	Min	Typ	Max	Units
--------	-----------	------------	-----	-----	-----	-------

DRAIN-SOURCE DIODE CHARACTERISTICS AND MAXIMUM RATINGS

I _S	Maximum Continuous Drain-Source Diode Forward Current				-0.67	A
V _{SD}	Drain-Source Diode Forward Voltage	V _{GS} = 0 V, I _S = -0.67 A (Note 2)		-0.75	-1.2	V

Notes:

1. R_{θJA} is the sum of the junction-to-case and case-to-ambient thermal resistance where the case thermal reference is defined as the solder mounting surface of the drain pins. R_{θJA} is guaranteed by design while R_{θJC} is determined by the user's board design.

$$P_D(t) = \frac{T_J - T_A}{R_{\theta JA}(t)} = \frac{T_J - T_A}{R_{\theta JC} + R_{\theta CA}(t)} = I_D^2(t) \times R_{DS(ON)}@T_J$$

Typical R_{θJA} using the board layouts shown below on 4.5"x5" FR-4 PCB in a still air environment:

156°C/W when mounted on a 0.0025 in² pad of 2oz copper.

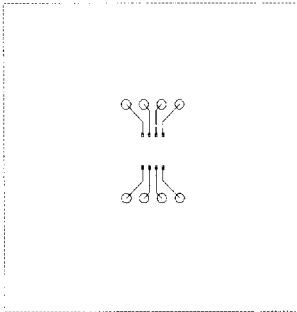

Scale 1 : 1 on letter size paper

2. Pulse Test: Pulse Width ≤ 300μs, Duty Cycle ≤ 2.0%.

Typical Electrical Characteristics

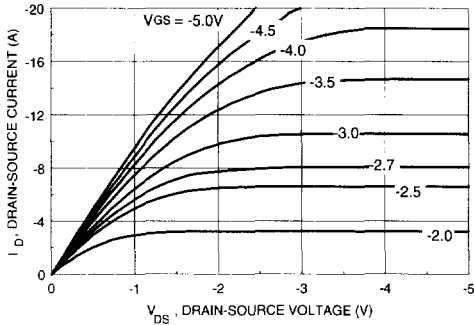

Figure 1. On-Region Characteristics.

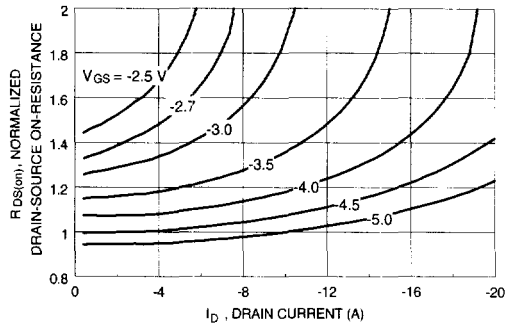

Figure 2. On-Resistance Variation with Gate Voltage and Drain Current.

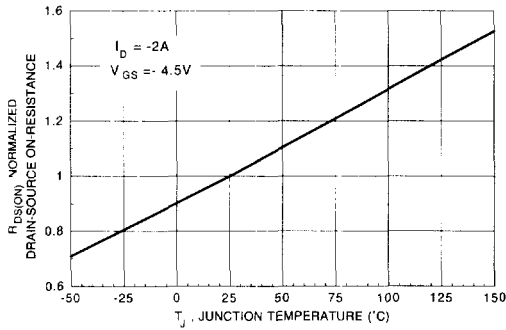

Figure 3. On-Resistance Variation with Temperature.

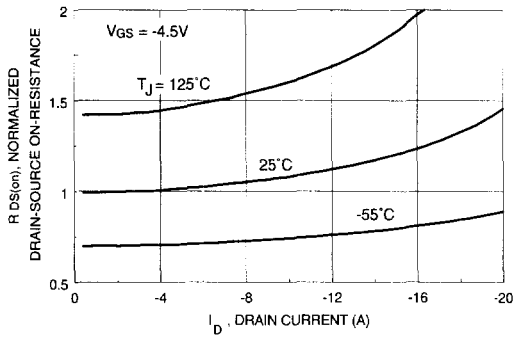

Figure 4. On-Resistance Variation with Drain Current and Temperature.

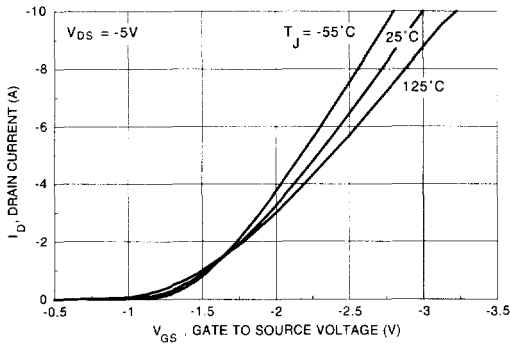

Figure 5. Transfer Characteristics.

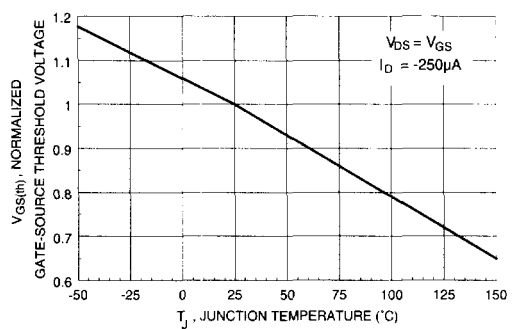

Figure 6. Gate Threshold Variation with Temperature.

Typical Electrical Characteristics

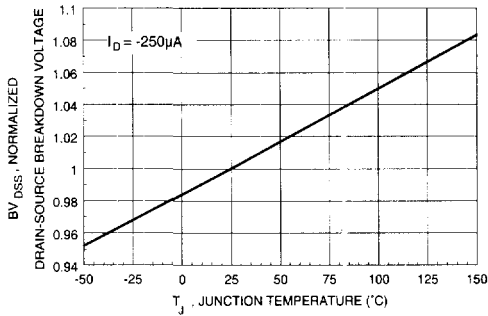

Figure 7. Breakdown Voltage Variation with Temperature.

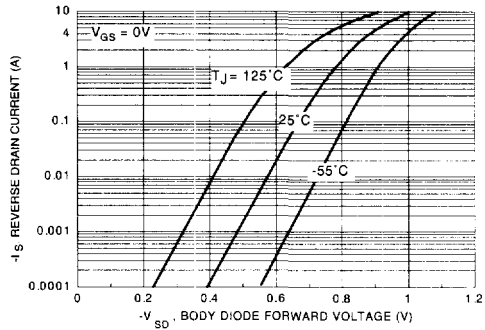

Figure 8. Body Diode Forward Voltage Variation with Current and Temperature.

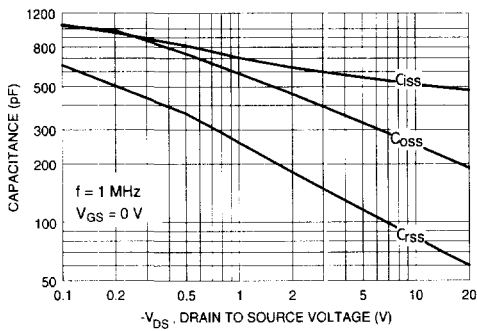

Figure 9. Capacitance Characteristics.

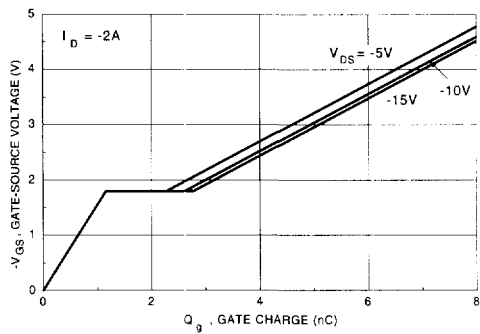

Figure 10. Gate Charge Characteristics.

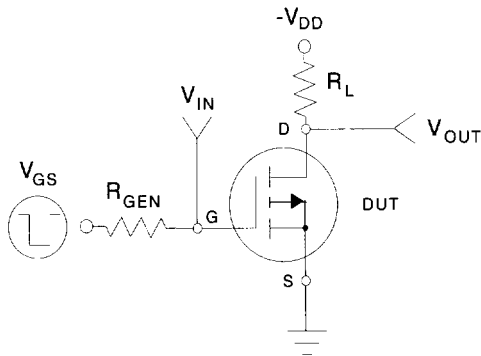

Figure 11. Switching Test Circuit.

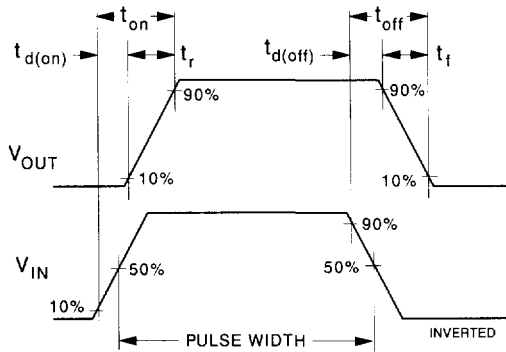

Figure 12. Switching Waveforms.

Typical Electrical and Thermal Characteristics

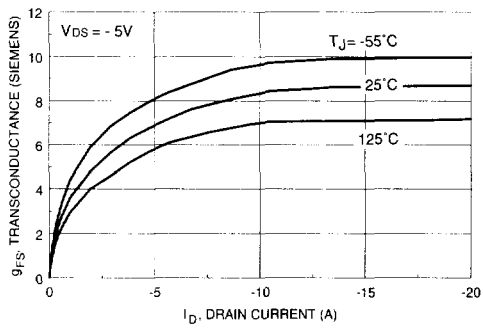

Figure 13. Transconductance Variation with Drain Current and Temperature.

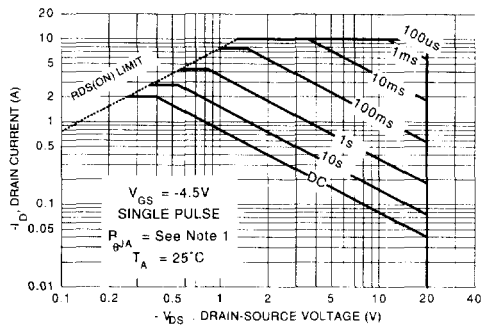

Figure 14. Maximum Safe Operating Area.

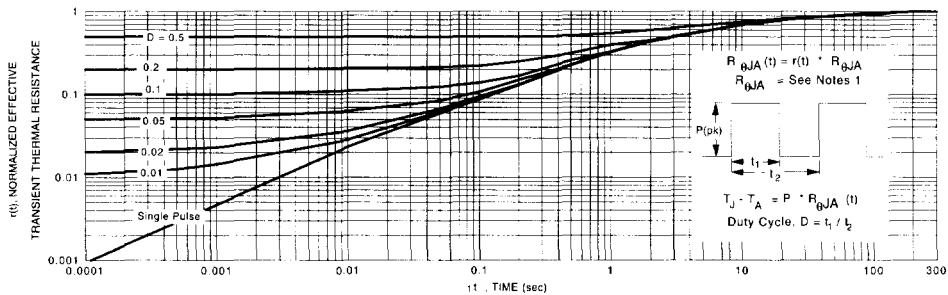

Figure 15. Transient Thermal Response Curve

Note: Thermal characterization performed using the conditions described in note1. Transient thermal response will change depending on the circuit board design.