

INA228, INA229, INA237, INA238, and INA239 EVM User's Guide



ABSTRACT

This user's guide describes the characteristics, operation, and use of the INA228, INA229, INA237, INA238, and INA239 evaluation modules (EVMs). These EVMs are designed to evaluate the performance of the INA228, INA229, INA237, INA238, and INA239. Throughout this document, the terms evaluation board, evaluation module, and EVM are synonymous with the INA228EVM, INA229EVM, INA237EVM, INA238EVM, and INA239EVM. This document includes a schematic, reference printed-circuit board (PCB) layouts, and a complete bill of materials (BOM).

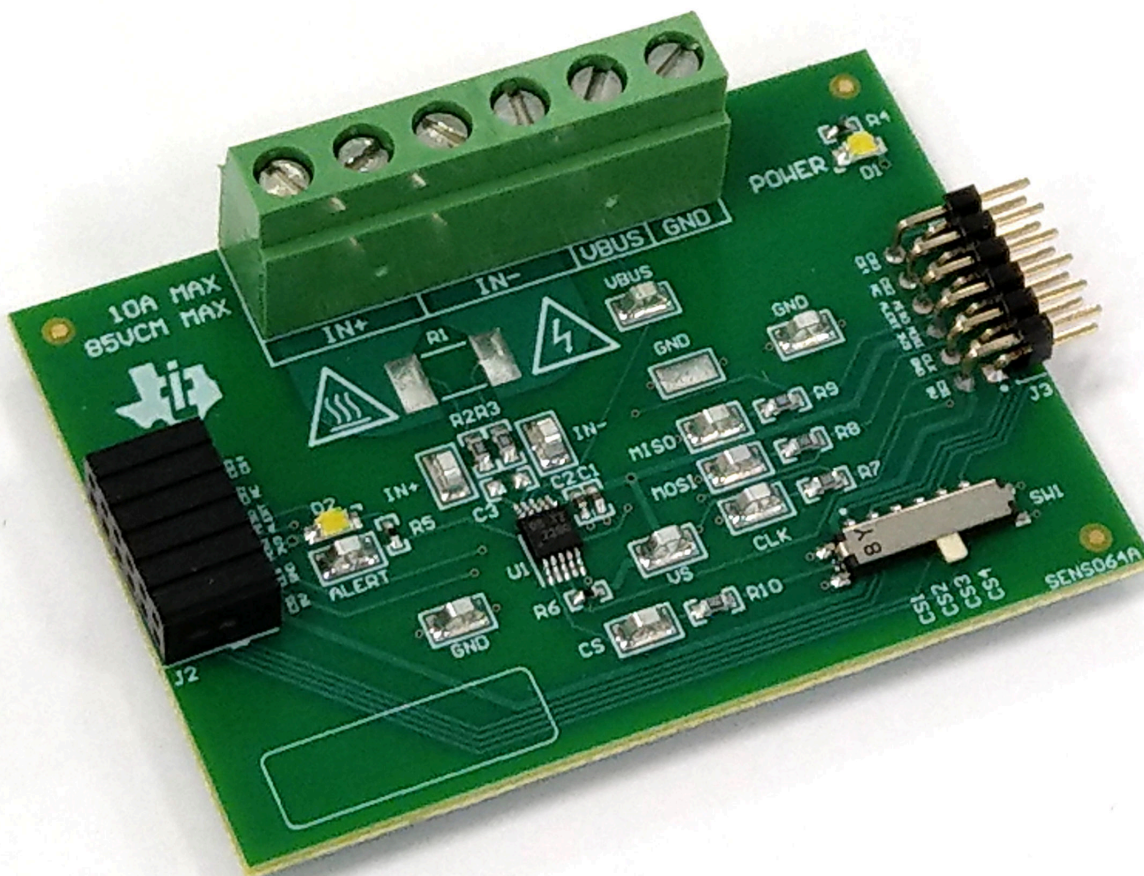

Table of Contents

1 Trademarks	2
General Texas Instruments High Voltage Evaluation (TI HV EVM) User Safety Guidelines	3
2 Overview	5
2.1 Kit Contents.....	5
2.2 Related Documentation From Texas Instruments.....	6
3 Hardware	6
3.1 Features.....	6
4 Operation	7
4.1 Quick Start Setup.....	7
4.2 EVM Operation.....	7
5 Circuitry	22
5.1 Current Sensing IC.....	22
5.2 Input Signal Path.....	22
5.3 Digital Circuitry.....	22
6 Schematics, PCB Layout, and Bill of Materials	23
6.1 Schematics.....	23
6.2 PCB Layout.....	27
6.3 Bill of Materials.....	29
7 Revision History	32

1 Trademarks

All trademarks are the property of their respective owners.

General Texas Instruments High Voltage Evaluation (TI HV EVM) User Safety Guidelines



Always follow TI's set-up and application instructions, including use of all interface components within their recommended electrical rated voltage and power limits. Always use electrical safety precautions to help ensure your personal safety and those working around you. Contact TI's Product Information Center [http://ti.com/customer support](http://ti.com/customer-support) for further information.

Save all warnings and instructions for future reference.

WARNING

Failure to follow warnings and instructions may result in personal injury, property damage or death due to electrical shock and burn hazards.

The term TI HV EVM refers to an electronic device typically provided as an open framed, unenclosed printed circuit board assembly. It is *intended strictly for use in development laboratory environments, solely for qualified professional users having training, expertise and knowledge of electrical safety risks in development and application of high voltage electrical circuits. Any other use and/or application are strictly prohibited by Texas Instruments.* If you are not suitably qualified, you should immediately stop from further use of the HV EVM.

1. Work Area Safety:

- a. Keep work area clean and orderly.
- b. Qualified observer(s) must be present anytime circuits are energized.
- c. Effective barriers and signage must be present in the area where the TI HV EVM and its interface electronics are energized, indicating operation of accessible high voltages may be present, for the purpose of protecting inadvertent access.
- d. All interface circuits, power supplies, evaluation modules, instruments, meters, scopes, and other related apparatus used in a development environment exceeding 50Vrms/75VDC must be electrically located within a protected Emergency Power Off EPO protected power strip.
- e. Use stable and non-conductive work surface.
- f. Use adequately insulated clamps and wires to attach measurement probes and instruments. No freehand testing whenever possible.

2. Electrical Safety:

- a. As a precautionary measure, it is always good engineering practice to assume that the entire EVM may have fully accessible and active high voltages.
- b. De-energize the TI HV EVM and all its inputs, outputs and electrical loads before performing any electrical or other diagnostic measurements. Revalidate that TI HV EVM power has been safely de-energized.
- c. With the EVM confirmed de-energized, proceed with required electrical circuit configurations, wiring, measurement equipment hook-ups and other application needs, while still assuming the EVM circuit and measuring instruments are electrically live.
- d. Once EVM readiness is complete, energize the EVM as intended.

WARNING

While the EVM is energized, never touch the EVM or its electrical circuits, as they could be at high voltages capable of causing electrical shock hazard.

3. Personal Safety

- a. Wear personal protective equipment e.g. latex gloves or safety glasses with side shields or protect EVM in an adequate lucent plastic box with interlocks from accidental touch.

Limitation for safe use:

EVMs are not to be used as all or part of a production unit.

2 Overview

The INA228, INA229, INA237, INA238, and INA239 devices are digital power monitors with integrated 20-bit (INA229 and INA228) and 16-bit (INA237, INA238, and INA239) delta-sigma ADCs specifically designed for current-sensing applications. The devices can measure a selectable full-scale differential input of ± 163.84 mV or ± 40.96 mV across the shunt with common-mode voltage support from -0.3 V to $+85$ V. For the INA228 and INA229, built-in digital accumulation calculates average power, internal die temperature, energy, and charge accumulation. For the INA237, INA238, and INA239, built-in digital accumulation calculates average power and internal die temperature. All devices also have built-in diagnostics to indicate system health accessible through a digital output pin, ALERT. The devices operate from a single supply of 2.7 V to 5.5 V, drawing < 1.1 -mA current during operation and < 5 - μ A current during shutdown. The output can be interfaced with a multitude of microcontrollers (MCUs) with a standard 4-wire SPI interface (INA229 and INA239) or with a standard I2C interface (INA228, INA237, and INA238).

Table 2-1. Device Summary

PRODUCT	DIGITAL PROTOCOL	ADC RESOLUTION	MAX GAIN ERROR	MAX OFFSET VOLTAGE
INA228	I2C	20-bit	0.05%	± 1 μ V
INA229	SPI	20-bit	0.05%	± 1 μ V
INA237	I2C	16-bit	0.3%	± 50 μ V
INA238	I2C	16-bit	0.1%	± 5 μ V
INA239	SPI	16-bit	0.1%	± 5 μ V

2.1 Kit Contents

Table 2-2 lists the contents of the EVM kit. Contact [Texas Instruments Customer Support](#) if any component is missing.

Table 2-2. Kit Contents

ITEM	QUANTITY
INA228EVM, INA229EVM, INA237EVM, INA238EVM, OR INA239EVM test board	1

Note that this EVM requires the TI Sensor Control Board (SCB), which is sold separately.

2.2 Related Documentation From Texas Instruments

This user's guide is available from the TI website under literature number [SBOU241](#). Any letter appended to the literature number corresponds to the document revision that is current at the time of the writing of this document. Newer revisions are available from www.ti.com or the Texas Instruments' Literature Response Center at (800) 477-8924 or the Product Information Center at (972) 644-5580. When ordering, identify the document by both title and literature number. [Table 2-3](#) lists documentation related to the EVM. Click the links in [Table 2-3](#) for further information. The device name links to the product web folder on www.ti.com. The literature number links to the document PDF.

Table 2-3. Related Documentation

DOCUMENT TITLE	DOCUMENT LITERATURE NUMBER
INA228 data sheet	SLYS021
INA228-Q1 data sheet	SLYS022
INA229 data sheet	SLYS023
INA229-Q1 data sheet	SLYS024
INA237 data sheet	SBOSA20
INA237-Q1 data sheet	SBOSA27
INA238 data sheet	SLYS025
INA238-Q1 data sheet	SLYS026
INA239 data sheet	SLYS027
INA239-Q1 data sheet	SLYS028
Getting Started with Digital Power Monitors	SBOA511

3 Hardware

The EVM is an easy-to-use platform for evaluating the main features and performance of the INA228, INA229, INA237, INA238, or INA239. The EVM supports current measurements up to 10 amps through the PCB, and includes a graphical user interface (GUI) used to read and write device registers as well as view and save results data.

The EVM is intended to provide basic functional evaluation of the devices. The layout is not intended to be a model for the target circuit, nor is it laid out for electromagnetic compatibility (EMC) testing. The EVM consists of two printed-circuit boards (PCBs). The larger PCB is referred to as the EVM, and has either the INA228, INA229, INA237, INA238, or INA239 installed. The smaller PCB is referred to as the SCB Controller, and is used to interface the EVM with the GUI.

3.1 Features

- GUI support to read and write device registers as well as view and save results data
- EVM detached from SCB for custom use cases
- Multiple EVM support with single SCB/GUI
- Conveniently powered from a common micro-USB connector through the SCB

4 Operation

4.1 Quick Start Setup

The following instructions describe how to set up and use the EVM.

1. Purchase an SCB if you do not already have one.
 - a. To use a PAMB Controller instead, see [PAMB Compatibility](#).
2. Download this driver and install it **as an administrator**: <https://www.ti.com/lit/zip/sbac253>.
 - a. Follow the download prompts, a myTI account will be required.
 - b. Note that this driver is labeled as a PAMB driver, but is also used for the SCB.
3. Attach the EVM to the SCB Controller as shown in [Figure 4-1](#).
 - a. Refer to [Figure 4-2](#) when connecting multiple EVMs of the same type together.
4. Connect the EVM to the PC using the provided USB cable.
 - a. Insert the micro USB cable into the SCB Controller onboard USB receptacle J2.
 - b. Plug the other end of the USB cable into a PC.
5. Access the GUI from this link in either Chrome, Firefox, or Safari: https://dev.ti.com/gallery/info/CurrentSensing/INA228_229_237_238_239EVM_GUI/.
6. Connect the GND reference of the external system to the GND node of the EVM (pin 1 of J1).
7. Provide a differential input voltage signal to the IN+ and IN- nodes by connecting the signal leads to J1 pin 5 or 6 and J1 pin 3 or 4 on the EVM as explained in [Current Sensing Operation](#).

4.2 EVM Operation

To use the EVM with the SCB Controller (sold separately), connect the EVM as shown in [Figure 4-1](#).

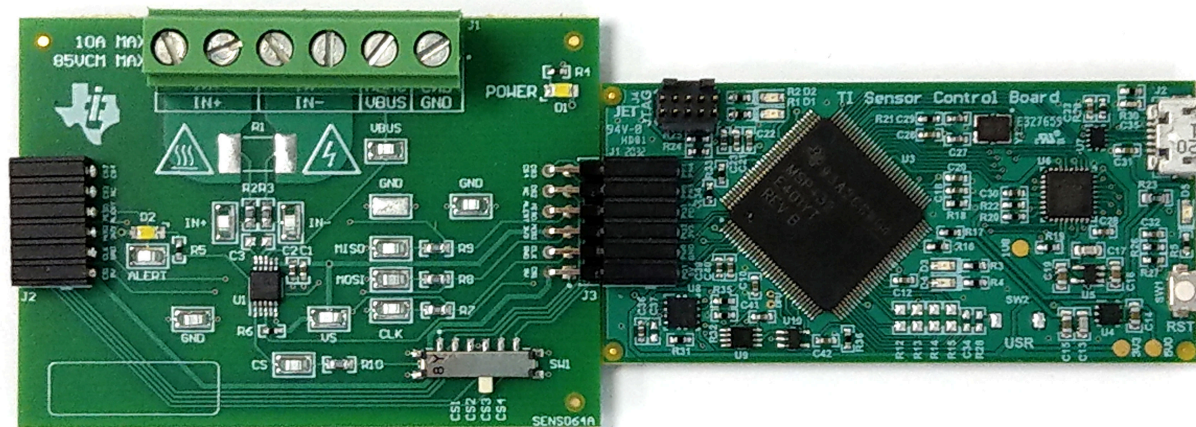

Figure 4-1. EVM (Left) Connected to SCB Controller (Right)

If using multiple EVMs, connect them as shown in [Figure 4-2](#). Make sure to use a different chip select/address for each device. The GUI only supports one EVM/device type at a time, up to 4 EVMs total.

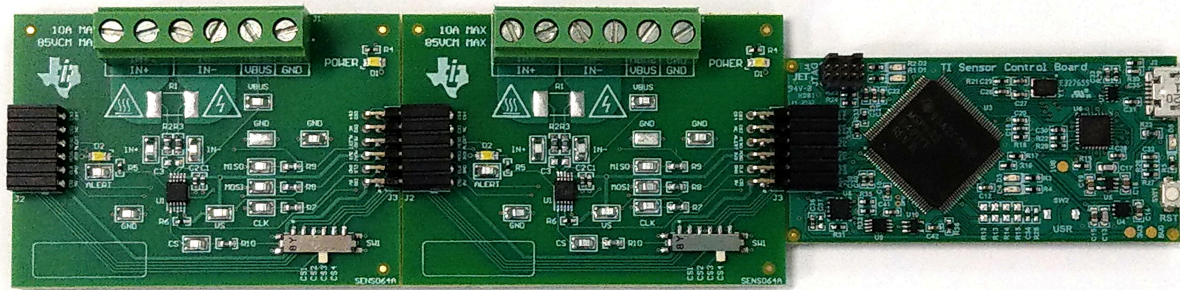

Figure 4-2. Multiple EVMs Connected to SCB Controller

4.2.1 Setup

4.2.1.1 Driver Installation

Download and install this driver: <https://www.ti.com/lit/zip/sbac253>. This is a one-time step per computer, and will require a myTI account. Note that this driver is labeled as a PAMB driver, but is also used for the SCB. Unzip the folder and **run the .exe file with administrator privileges**.

4.2.1.2 Firmware

Firmware updates will be pushed through the GUI if the previous driver was installed. Downloaded offline GUIs will only update the SCB Controller with the latest firmware available at the time of download. To check for the latest GUI or Firmware updates, launch the latest GUI version from the web browser.

4.2.1.2.1 Firmware Debug

If the firmware must be manually reinstalled for any reason, follow these steps to reinstall the firmware. Make sure the EVM is connected to the SCB.

1. First, see if the GUI can program the firmware manually.
 - a. Plug in the SCB controller to the PC
 - b. Launch the GUI
 - c. It is possible that the MCU has already entered Device Firmware Update (DFU) mode. If so, the GUI may notify you and try to update the firmware to the latest version.
 - d. If it does not update automatically, go to *File > Program Device...*
2. If step 1 is unsuccessful (or if the *Program Device* button is grayed out), manually configure the MCU on the SCB Controller to be in DFU Mode. This can be done through either of the below methods with the SCB Controller powered on:
 - a. Through software:
 - Send the command 'bsl' on the SCB's USB Serial (COM) port.
 - b. Though hardware:
 - For safety, **turn off and disconnect all load sources and external voltages**.
 - While shorting the two test points labeled *DFU* (shown in [Figure 4-3](#)) with a pair of tweezers (or wire), press and release the RESET button.

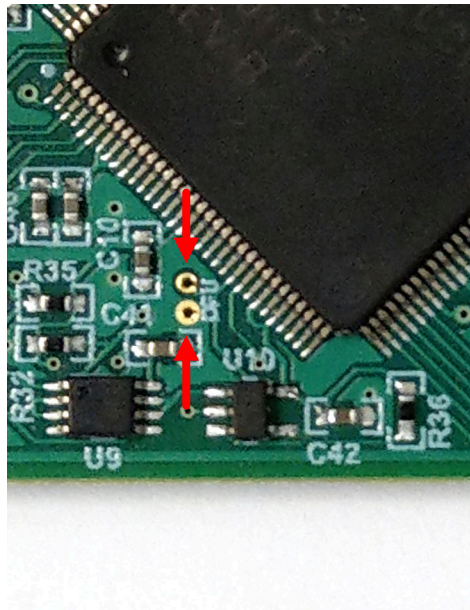

Figure 4-3. Test Points Used to Enter DFU Mode Manually

- If you are using the PAMB board instead, these test points are placed near PK1 and PK2.

With the MCU in DFU mode, the firmware can now be uploaded through the method outlined in [Step 1](#).

4.2.1.3 GUI Setup and Connection

You can access the GUI from this link in either Chrome, Firefox, or Safari: https://dev.ti.com/gallery/info/CurrentSensing/INA228_229_237_238_239EVM_GUI/.

4.2.1.3.1 Initial Setup

To set up the GUI the first time:

1. Make sure that the previously mentioned driver was installed successfully to ensure that everything works properly and that the GUI can update the EVM firmware, if necessary.
2. Check to make sure the EVM/SCB Controller unit is plugged into the PC, then go to the previously-provided GUI link.
3. Open the *GUI Composer* application to launch the GUI from the web browser (see [Figure 4-4](#)).

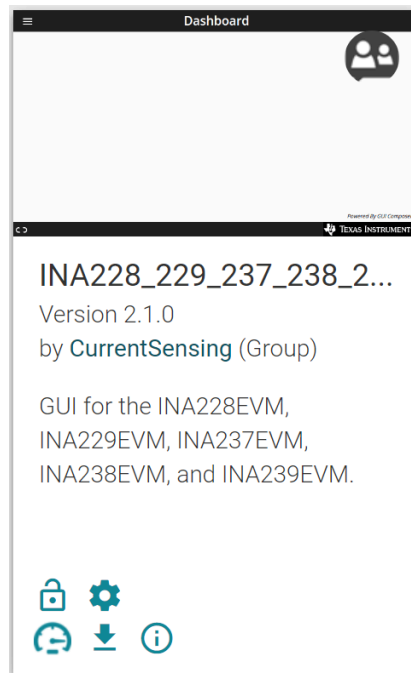

Figure 4-4. GUI Composer Application

- The GUI link will bring up all versions of the GUI. TI recommends to launch the newest version available.
- For first-time GUI Composer setup, follow the prompts to download the *TI Cloud Agent* and browser extension (see [Figure 4-5](#)). These prompts will appear after you close the *README.md* dialog box.

TI Cloud Agent Installation

Hardware interaction requires additional one time set up. Please perform the actions listed below and try your operation again.(What's this?)

- Step 1: **INSTALL** browser extension
- Step 2: **DOWNLOAD** and install the TI Cloud Agent Application
- Help. I already did this

FINISH

Figure 4-5. TI Cloud Agent

- To download the GUI for offline use, click the  icon in the *GUI Composer* application and follow the prompts (see [Figure 4-4](#)).

4.2.1.3.2 GUI to EVM Connection

To connect the GUI to the EVM, follow these steps:

- Setup and launch the GUI as described in [Initial Setup](#).
- Check to make sure that the EVM connected to the GUI, then close the *README.md* file page to initiate the connection. If successful, the text *Hardware Connected* should be visible near the bottom left corner of the GUI.



Figure 4-6. Hardware Connected

- a. A green indicator with the device type and the text *DEVICE CONNECTED* should also be visible near the top left of the GUI.



Figure 4-7. Device Connected

- b. If the text *Hardware Connected* and *DEVICE CONNECTED* do not show in the GUI, long-press the RESET button on the EVM to try again.
 - i. If that option does not work, check different hardware COM ports under *Options > Serial Port*.

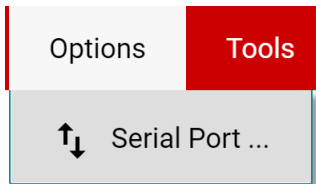

Figure 4-8. Change Serial Port

- c. If the hardware still does not connect, make sure you are using the correct GUI/EVM combination.
 - i. If you are using the correct GUI/EVM combination, you may need to reprogram the firmware of the SCB as described in [Firmware Debug](#).
 - ii. Many connectivity issues can be addressed by doing one of the following:
 1. Long-press the RESET button on the EVM with the EVM and SCB connected to each other.
 - Refreshing the GUI can also sometimes help this.
 2. Connect the EVM to a different USB port.
 - Avoid using long cables and USB hubs.
 - If you are using a desktop PC, try a USB port on the back.

4.2.2 GUI Operation

Setup, launch, and connect the GUI to the EVM per [GUI Setup and Connection](#). Refer to the sections below for a description on how to use each page of the GUI.

4.2.2.1 Homepage Tab

The GUI starts out on the homepage tab. Click the  (Home) icon on the menu to the left to return to the homepage tab at any time.

From the homepage, you can easily confirm successful GUI to EVM connection (see [GUI to EVM Connection](#)), as well as access helpful resources through the buttons on the bottom (see [Figure 4-9](#)).

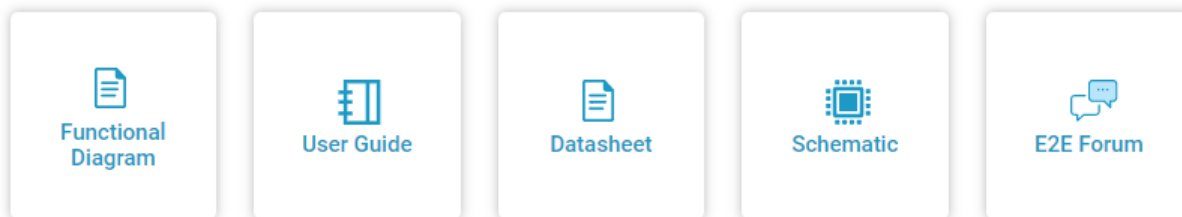



Figure 4-9. Home Tab Links

4.2.2.2 Configuration Tab

To do the initial setup for each connected EVM, click the  (Configuration) icon on the menu to the left. [Figure 4-10](#) shows an example of the configuration tool, which may change based on the device connected.

Number of EVMs: <input type="text" value="2 EVMs"/>	Selected EVM: <input type="text" value="EVM 1"/>
<h3 style="margin: 0;">EVM 1</h3>	
Hardware Switch Settings SW1: <input type="text" value="CS1"/>	
Shunt Full-Scale Differential Range ADCRANGE: <input type="text" value="±163.84 mV"/>	
Shunt/Current Configuration	
RSHUNT:	<input type="text"/> mΩ
Max Expected Current:	<input type="text"/> A
CURRENT_LSB:	<input type="text"/> A
SHUNT_CAL:	<input type="text" value="4096"/>
True CURRENT_LSB:	<input type="text"/> A
True Max Current:	<input type="text"/> A
Required Sensing Range:	<input type="text"/> mV

Figure 4-10. Configuration Tool

From this page you can set the number of EVMs you are using, and then for each EVM you can indicate the physical hardware switch settings and configure your shunt and CURRENT_LSB. Below is a description of each option and field on this page:

- Number of EVMs
 - This setting is used to tell the GUI how many EVMs are connected to the SCB.
 - Note, the SCB and GUI only support up to 4 EVMs at a time with the same device on each EVM.
 - Changing this here also changes the same setting in the Results Data tab.
- Selected EVM
 - This setting indicates which EVM you are currently changing settings for.
 - This also selects the EVM that is connected to the Registers page.
- Hardware Switch Settings
 - Set these settings to match the physical switch settings on the EVM.
 - Note, this setting needs to be set before changing any other settings on this page. The GUI will block the other settings until this is set.
 - Changing this here also changes the same setting in the Results Data tab.
- Shunt Full-Scale Differential Range
 - This is a shortcut to the ADCRANGE setting from the registers page, placed here for convenience.
 - Both this setting and the ADCRANGE setting from the register page change together.
- Shunt/Current Configuration
 - This section is used to input shunt information as well as to help calculate the CURRENT_LSB and set the SHUNT_CAL register. Here is a description of how to use each field:
 - RSHUNT
 - Input the value of the used shunt resistor in mΩ.
 - Max Expected Current
 - Input the value of the maximum expected current across the shunt resistor in Amps.
 - If the Max Expected Current field is left blank, then SHUNT_CAL can be adjusted manually, and the tool will tell you the True Max Current that can be measured with the EVM.
 - CURRENT_LSB
 - This is the calculated CURRENT_LSB value in Amps. This field gets populated automatically from the Max Expected Current field.
 - This field can be changed manually if desired, and changes will filter downward.
 - SHUNT_CAL
 - Calculated value for SHUNT_CAL based off of RSHUNT and CURRENT_LSB. When this field changes, the value is automatically written to the SHUNT_CAL register.
 - When CURRENT_LSB is specified, changing ADCRANGE will adjust this value automatically per data sheet equations.
 - This will happen if ADCRANGE is changed from either the configuration page or the register map.
 - If CURRENT_LSB is not specified, this value will remain unchanged, but the fields below will adjust to the new ADCRANGE.
 - This field can be changed manually if desired, and changes will filter downward.
 - Changing this value from the register map page also changes it here.
 - True CURRENT_LSB
 - This is the actual CURRENT_LSB value in Amps back calculated from the SHUNT_CAL register with the given shunt resistor value.
 - This is the value used for calculations in the Results Data section.
 - True Max Current
 - This is the maximum measurable current in Amps based off of the VSHUNT and CURRENT registers, using RSHUNT and the True CURRENT_LSB for calculations.
 - Required Sensing Range
 - This shows the required sensing range to measure the Max Expected Current with the specified shunt resistor.
 - If a Max Expected Current is not specified, then the True Max Current field will be used instead.

4.2.2.3 Registers Tab

To view and edit the device registers, click the  (Registers) icon on the menu to the left. The registers tab will look similar to the one shown in [Figure 4-11](#), depending on the device connected.

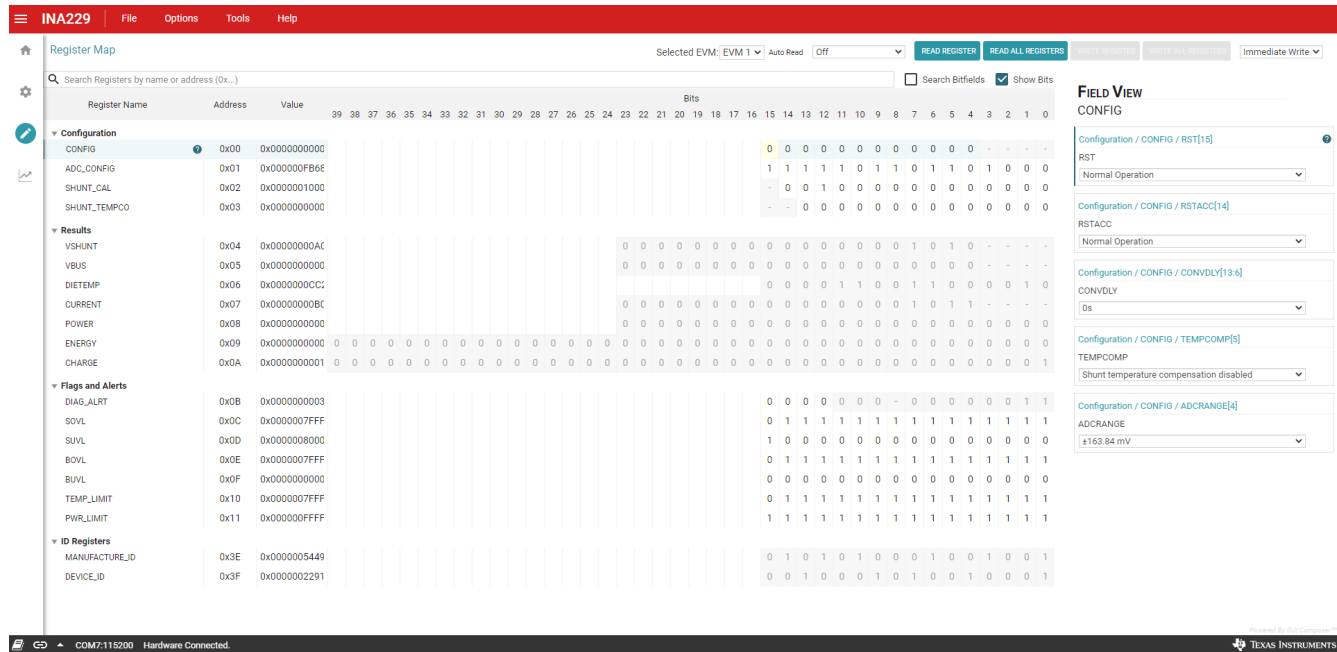



Figure 4-11. GUI Registers Tab

From this page, you can read and write device registers on the EVM. Here are some important notes:

- Use the *Selected EVM* drop-down menu at the top to choose which device to work with on the register map.
 - Note, changing this here also changes the same setting for the *Configuration* tab.
 - Functionally, this button sets the default read/write address in the MCU and then reads all register values back to update the register map. Note that if data is collected at a high frequency, then this may cause a minor delay in the data collection. For optimal performance, set the device settings before you start collecting data.
- By default, all changes are automatically written to the device. If desired, you can change the *Immediate Write* setting to *Deferred Write* to only allow writing when you are ready.
 - You can modify writable register values from any of these methods:
 - Through the widget settings in the *Field View* section on the right.
 - Changing the *Value* directly with either hex or decimal values.
 - Double-clicking on any individual bit.
- Turning on *Auto Read* will only update registers in the register map, and not the plots in the *Results Data* section.
 - Leaving *Auto Read* on while collecting data for plots can interfere with data collection timing.
- For questions about a register or register bit field, click the  icon.
 - For even more questions about registers, check the data sheet.
- For convenience, register settings can be saved and loaded back later to any device with the same register map. To do this, go to *File > Register Data*, as shown in [Figure 4-12](#).

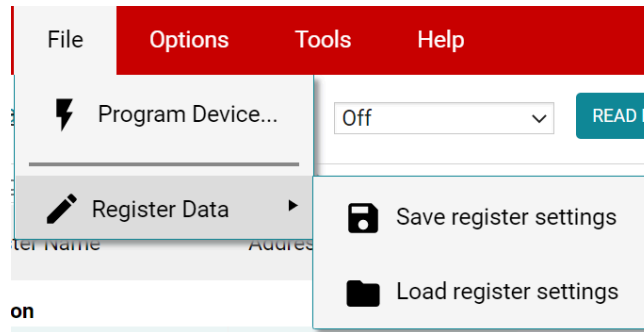

Figure 4-12. Save and Load Register Settings

- TI recommends to press the *Read All Registers* button after loading data to update the register map with the actual device values, in case the loaded registers were not compatible with the connected device.

4.2.2.4 Results Data Tab

To view and collect results data over time, click the (Results Data) icon on the menu to the left. Figure 4-13 shows part of the results data page for reference, which may look different depending on the connected device.

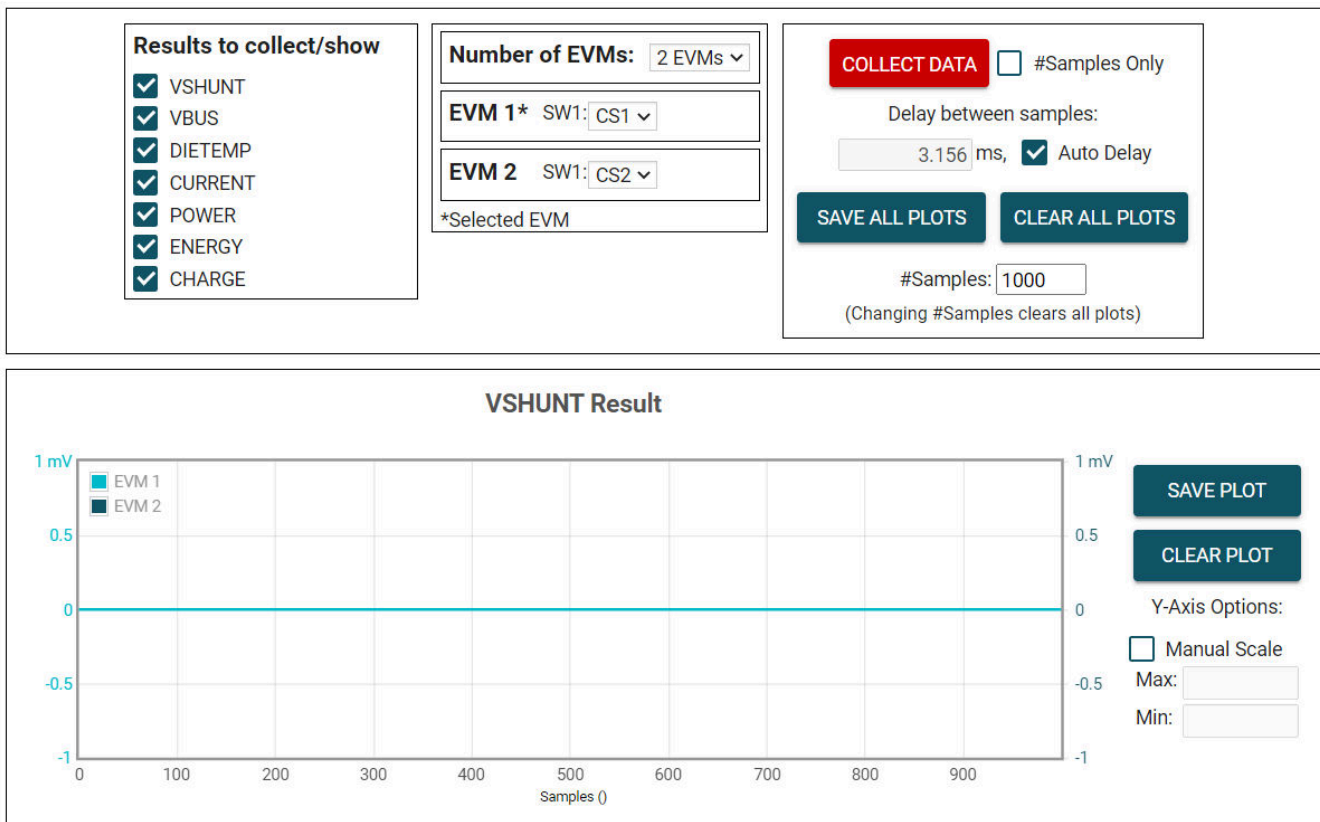

Figure 4-13. Results Page and Settings

Below is a description of how to use the buttons and settings at the top of the results data page and next to each plot:

- Results to collect/show
 - Use this section to select which register values to collect data for. If a results register is unselected before the *COLLECT DATA* button is pressed, then the plot below will be hidden and the EVM will not try to read this register during the collect cycle (even if the conversion is enabled).
 - If you disable one of these settings while the EVM is collecting data, then the plot will not show, but data will still be collected and the plot will update in the background. Simply reselect to show data.

- Number of EVMs
 - Set the *Number of EVMs* drop-down menu to the number of EVMs currently in use.
 - See [Figure 4-2](#) for how to attach multiple EVMs together.
 - Changing this here also changes the same setting in the Configuration tab.
 - The GUI only supports one EVM/device type at a time, up to 4 EVMs total.
 - Switch settings
 - Use the onboard switch(es) to select a different address/chip select for each EVM.
 - Set the switch settings in the GUI to match the setting for each connected EVM.
 - *EVM 1* will automatically populate with the lowest addressed device unless a setting has already been selected.
 - Changing this here also changes the same setting in the Configuration tab.
 - If more than one device is being used, a * symbol will appear next to the selected EVM that is being used on the register map and configuration tabs.
 - Changing the switch settings of any EVM sets that EVM as the selected EVM.
- Collect/Plots settings
 - Collect Data
 - Press the *COLLECT DATA* button to start data collection.
 - In this mode, the MCU reads and sends the selected result values for each device over a USB BULK channel. All results from one device are read before moving on to the next device.
 - All result values from all EVMs together are considered one "sample set".
 - Although you can read and write to other registers through the register map page while collecting data, it is possible that this adds a delay to the data being collected.
 - Press the *STOP COLLECT* button to stop collecting data.
 - #Samples Only
 - If this checkbox is selected, then the GUI will automatically stop collecting data after the number of samples specified in the #Samples box have been collected.
 - If not selected, the GUI will continue collecting data and only store the most recent #Samples.
 - Delay between samples
 - Sets the delay between the start of each sample set.
 - Desired delay time may not be obtainable if it is set faster than the read loop, which depends on the number of results being collected, the number of EVMs, and your CPU.
 - Although you can read and write to other registers through the register map page while collecting data, it is possible that this adds a delay to the data being collected.
 - Auto Delay
 - Sets delay based on conversion times, averaging, and number of channels being converted.
 - If multiple EVMs are being used, the time put in the delay box will be from the EVM with the shortest calculated delay value.
 - Save All Plots
 - Press the *SAVE ALL PLOTS* button to save the data for each currently selected result from the *Results to collect/show* section in a spreadsheet.
 - Press the *SAVE PLOT* button next to each plot to save just the data from that plot in a spreadsheet.
 - Clear All Plots
 - Press the *CLEAR ALL PLOTS* button to clear the data from all plots together.
 - Press the *CLEAR PLOT* button next to each plot to clear the data from just that plot.
 - #Samples
 - Change the number in this box to change the number of samples shown in each plot.
 - Changing this number clears out the plot buffers, so the plots will be cleared on the next read.
 - Y-Axis Options
 - Manual Scale
 - Checking this box will set all EVM results in this plot to the same scale value specified by the Max and Min fields.
 - When this is not selected, each EVM will have it's own Y-axis scale based on the min and max value for that EVM's result values.
 - For the DIETEMP Result, the units can also be toggled between °C and °F.

- This processes the existing data in the plots, and converts new data coming in. If receiving new data while changing units, it is possible that a datapoint gets missed or duplicated.
- Max
 - The maximum Y-axis value to use for all EVMs in this plot.
 - If this field is empty when *Manual Scale* is selected, then it will auto populate with the maximum value currently in the plot.
- Min
 - The minimum Y-axis value to use for all EVMs in this plot.
 - If this field is empty when *Manual Scale* is selected, then it will auto populate with the minimum value currently in the plot.

4.2.3 Current Sensing Operation

The EVM can be used with either an onboard or external shunt resistor. To use the onboard shunt resistor, solder a 2512 surface-mount technology (SMT) shunt resistor across the pads of R1, and connect it in series with the external system and load current through J1. An external shunt can be connected directly across the terminals of J1. There are two terminals each for IN+ (J1 pins 5 and 6) and IN– (J1 pins 3 and 4) for convenience.

4.2.3.1 Detailed Setup

To configure a measurement evaluation, follow these steps:

1. Connect a shunt resistor by doing either of the following:
 - a. Solder a 2512 resistor across the pads of R1 that connects the IN+ and IN– inputs.
 - b. Connect an external shunt across the IN+ and IN– terminals of J1, preferably across pins 4 and 5, as shown in [Figure 4-14](#) and [Figure 4-15](#).
 - i. If an external shunt is being used, make the connections such that the sensing location is across the shunt and there will be no high current on the sensing path. See the [TI Precision Labs - Current Sense Amplifiers: Shunt Resistor Layout](#) video for more information.
2. Connect the IN+ and IN– terminals in series with the load while powered off.
 - a. When measuring more than 10 A, make sure the high current path does not go through the EVM (including the terminal block J1), as shown in [Figure 4-14](#).

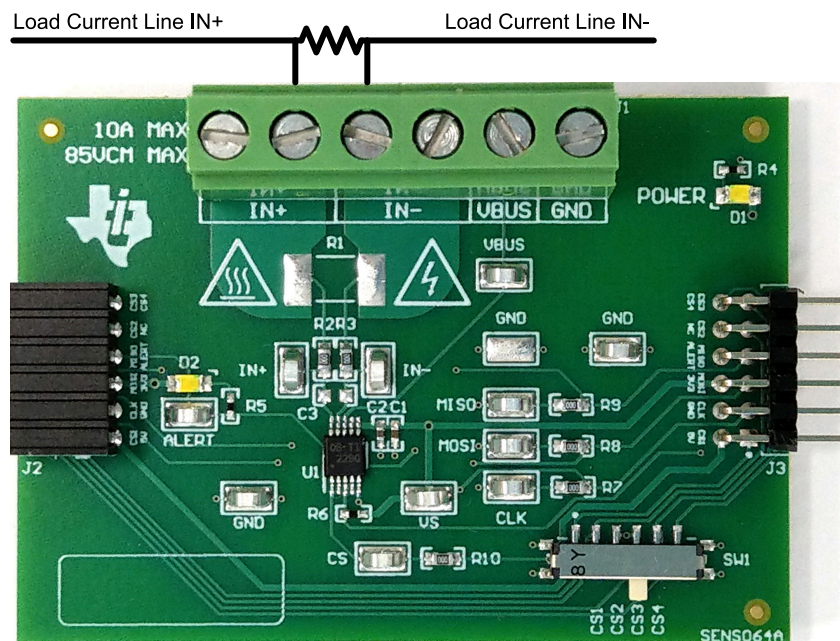

Figure 4-14. IN+ and IN– Wiring for More Than 10A

- b. When using 10 A or less with either an onboard or external shunt, the current path can be passed through the EVM. Figure 4-15 shows a convenient way to use the multiple IN+ and IN- terminals with an external shunt for this use case.

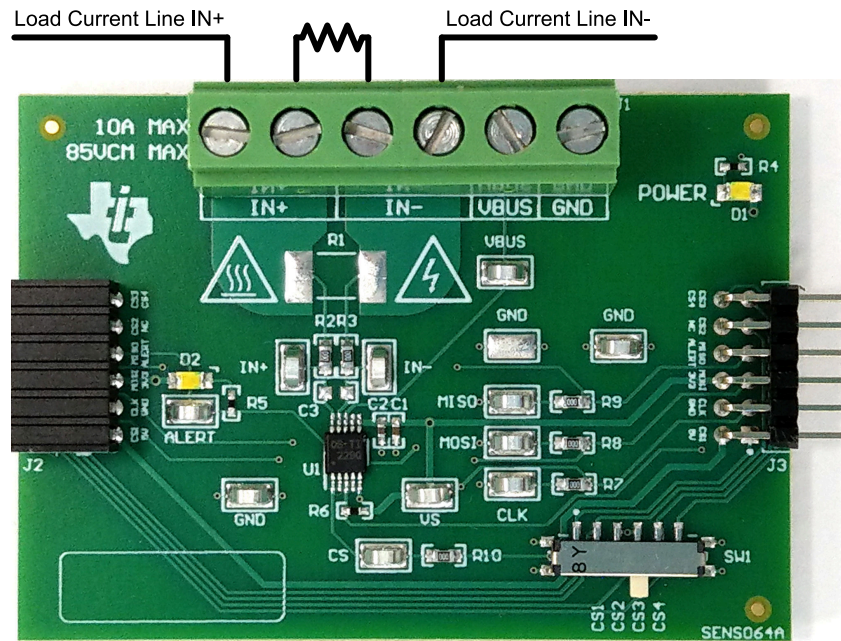

Figure 4-15. IN+ and IN- Wiring for 10A or Less

WARNING

When measuring current, first make sure that the equipment (shunt resistor, wires, connectors, and so on) can support the amperage and power dissipation. Secondly, make sure that the current flowing through J1 does not exceed 10 A. Failure to do so can result in damage to the EVM, or personal injury.

Do not touch high voltage terminals.

The EVM may get hot.

3. Connect the VBUS terminal (J1 pin 2) to the desired bus voltage (likely either IN+ or IN-).
 - a. If VBUS and dependent features are not being used, this channel can be used as an ADC input for another voltage.
4. Connect the system ground to the GND terminal (J1 pin 1).
5. Power on the system, and observe the device states and outputs through the GUI.

4.2.4 Direct EVM USB Communication

If desired, the EVM can be communicated with directly without the use of the GUI through the USB port. This is done by sending the desired command string over the serial COM port and receiving the results either through the COM port or the USB BULK channel, based on the mode. This is useful for interfacing the EVM with custom setups, scripts, or GUIs.

4.2.4.1 Standard USB Read and Write Operations

Use the serial COM port to read and write registers through USB commands using the following format:

- Set device address format: setdevice DEVID
 - Where setdevice is always lower case, and DEVID is defined as:
 - SPI
 - The chip select number. Ex, for chip select of 3, use 3.

- I2C
 - The 4 LSBs of the address in decimal format. Ex, for an address of 0x4A, use 10.
 - Note, when the SCB is reset while one or more EVMs are connected, the address will default to the lowest address/chip select found.
 - The SCB checks for I2C or SPI at start up, if no device is attached, it will default to SPI. Reset the SCB with an I2C EVM connected to use I2C.
 - For example, to set an I2C device with a register address of 0x4A you could send the command:
setdevice 10
 - For this example, the EVM would return the acknowledgment and state ("idle" or "collecting") in JSON format:

```

          {"acknowledge": "setdevice 10"}
          {"evm_state": "idle"}
          
```
- Read register format: rreg ADR
 - Where ADR is the address in hex, and rreg is always lower case.
 - Register addresses can be in upper or lower case, and do not need to be led by '0x'. 0 padding register addresses is also optional. For example, to read register address 0xB, some valid commands include:
 - rreg b
 - rreg 0B
 - rreg 0x0B
 - When '0x' is used, the 'x' must be lower case.
 - For this example, the EVM would return the results and state ("idle" or "collecting") in JSON format:

```

          {"acknowledge": "rreg 0x0B"}
          {"register": {"address": 11, "value": 3}}
          {"evm_state": "idle"}
          
```
- Write register format: wreg ADR VAL
 - Where ADR and VAL are in hex, and wreg is always lower case.
 - Register addresses and values can be in upper or lower case, and do not need to be led by '0x'. 0 padding register addresses and values is also optional. For example, to write register address 0x1 with the value 0xfb69, some valid commands include:
 - wreg 1 fb69
 - wreg 01 0xfb69
 - wreg 0x01 0xFB69
 - When '0x' is used, the 'x' must be lower case.
 - For this example, the EVM would return the results and state ("idle" or "collecting") in JSON format:

```

          {"acknowledge": "wreg 0x01 0xfb69"}
          {"console": "Writing 0xfb69 to ADC_CONFIG register"}
          {"evm_state": "idle"}
          
```

4.2.4.2 Collect Data Through the USB BULK Channel

The *Collect Data* function reads the desired result registers and sends the data based on the specified settings. This function works best with continuous conversion mode and does not configure the EVM or associated register settings for you. Collect mode started and stopped via the serial COM port, however the results will be sent over the USB BULK channel. To use this mode, use the following format:

- Start collecting data format: collect timerPeriod collectFlags channelAddressIDs numDevices
 - Where collect is always lower case, and each parameter is the decimal representation of the value in the following format:
 - timerPeriod
 - The timer delay used in the MCU to allow data collection sample sets (in μ s, unsigned 32-bit value).
 - collectFlags
 - a byte of data that has a 1 to collect and a 0 to not collect each register value type, according to the following definitions (note to only use energy and charge flags when the device supports that, otherwise set to 0):
 - VSHUNT = 0b1000000
 - VBUS = 0b0100000
 - DIETEMP = 0b0010000
 - CURRENT = 0b0001000
 - POWER = 0b0000100
 - ENERGY = 0b0000010
 - CHARGE = 0b0000001
 - channelAddressIDs
 - SPI
 - Each 4 bits is the chip select (CS) value for each EVM chained together starting with the LSBs (each CS can either be 1, 2, 3 or 4).
 - For example, if EVM 1 is on channel 1 and EVM 2 is on channel 3, the value here would be 0b00110001.
 - I2C
 - This is the 4 LSBs of each address chained together, starting with the LSBs.
 - For example, if EVM 1 is on channel 0x41 and EVM 2 is on 0x43, the value here would be 0b00110001
 - NumDevices
 - The number of EVMs chained together (1-4).
 - For example, to start data collection for VSHUNT, VBUS, and DIETEMP every 3.156 ms, for two INA229s with EVM 1 CS = 1 and EVM 2 CS = 3, you would send: collect 3156 112 49 2
 - For this example, the EVM would return the acknowledgment and state in JSON format:

```

              {"acknowledge":"collect 3156 112 49 2"}
              {"evm_state":"collecting"}
              
```
 - The USB BULK channel receives data in the format: frameID deviceNumID address registerSize data
 - Where each parameter is the decimal representation of the value in the following format:
 - frameID (1 byte)
 - Always reads 0. Used to ensure data is aligned.
 - deviceNumID (1 byte)
 - An ID number corresponding to the EVM number.
 - From the above example, this will be 1 if reading from EVM 1 which had CS set to 1, and 2 if reading from EVM 2 which had a CS set to 3.
 - address (1 byte)
 - The register address that was read from the device.
 - registerSize (1 byte)
 - The number of bytes that the following data will have.
 - data (1 byte at a time)
 - The register data value, given in bytes with the most significant byte first.

- Stop collecting data format: stop
 - Where stop is always lower case.
 - The EVM will return the acknowledgment and state in JSON format:

```

{"acknowledge":"stop"}
{"evm_state":"idle"}
  
```

4.2.5 PAMB Compatibility

If desired, this EVM and GUI can be used with the PAMB Controller (DC081A) by jumper wiring the pin headers of the PAMB to the EVM. [Figure 4-16](#) shows which pins on the PAMB correspond to the EVM header pins. Note not to add too much resistance in the jumper wire connection setup or the signal may degrade and cause communication errors.

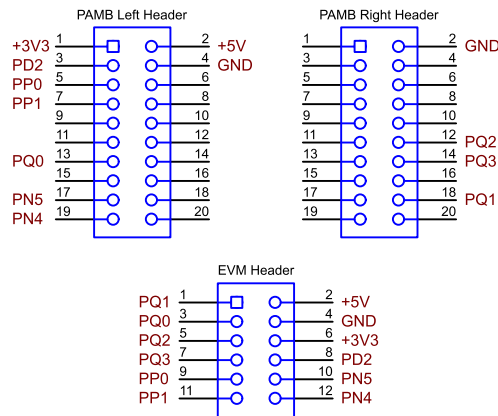

Figure 4-16. EVM to PAMB Connection

The new GUI and firmware can also be used with the SENS063A and SENS064A and PAMB Controller. If the firmware does not update automatically, DFU mode may need to be entered manually. See [Firmware Debug](#).

When using SENS064A on the PAMB with the new GUI/Firmware, only 1 device can be used at a time, with SW1 on the EVM set to CS3, and the GUI switch setting set to CS1.

5 Circuitry

This section summarizes the EVM subsystems and their components.

5.1 Current Sensing IC

This section describes the main INA device and supporting components.

U1 is the main INA current-sensing device (either the INA228, INA229, INA237, INA238, or INA239). C1 and C2 are bypass capacitors that are placed near the sensor to help mitigate power supply noise and provide current quickly to the device when needed. LED D1 with current limiting resistor R4 are used to indicate when the EVM is powered on.

The device pins can be monitored directly through the test points TP1 – TP12. Note that there are two extra test points on GND for convenience.

5.2 Input Signal Path

This section describes the circuitry of the input signal path.

J1 is the main connection terminal. Pin 1 of J1 is used to tie the system ground to the EVM ground. Pin 2 of J1 is used for the VBUS measurement within the sensor. Pins 3 and 4 are tied to IN–, and Pins 5 and 6 are tied to IN+. There are two pins each for IN– and IN+ for convenience.

R1 can be used for an optional onboard shunt resistor with a 2512 footprint. Alternatively, a shunt can be placed across the IN+ and IN– terminals of J1. If desired, a differential voltage can be applied directly for measurement tests.

C3, R2, and R3 combine to make an optional input filter. R2 and R3 are populated with 0-Ω resistors by default. When using input filtering, take into account the input bias current of the device. C3 can also be used without R2 and R3 to reduce noise. See the data sheet for more info on input filtering.

5.3 Digital Circuitry

This section describes the digital circuitry around the device.

5.3.1 I2C (INA228, INA237, INA238)

J2 and J3 are the main header pins that connect the digital and power pins to the SCB Controller or other EVMs. J3 connects to the EVM/SCB on the right, while J2 connects to more EVMs on the left. R5 and R6 are used as pullup resistors for the main digital IO pins.

SW0 and SW1 set the I2C address of the device. This can be useful when using the EVM with a custom controller (other than the SCB Controller), or when connecting multiple EVMs together. Currently the SCB Controller and GUI are set up to use four EVMs at a time.

R8 is used as a pullup resistor for the ALERT pin, which is routed to both J2 and J3. LED D2 and current limiting resistor R7 are used to indicate when the ALERT has triggered.

5.3.2 SPI (INA229, INA239)

J2 and J3 are the main header pins that connect the digital and power pins to the SCB Controller or other EVMs. J3 connects to the EVM/SCB on the right, while J2 connects to more EVMs on the left. R7–R10 are 0-Ω resistors in series with the main digital IO pins. Optionally, these resistor spaces can be used to provide inline filtering on the digital lines, or the resistors can be removed to disconnect the digital pins from the header pins.

SW1 is used to redirect the control signal line (CS) to 1 of 4 pins on J2 and J3. This can be useful when using the EVM with a custom controller (other than the SCB Controller), or when connecting multiple EVMs together. Currently the SCB Controller and GUI are set up to use four EVM at a time. (Note, if using the PAMB Controller and the SENS064A EVM, you can only use one EVM at a time, with SW1 on the EVM set to CS3, and the GUI switch setting set to CS1.)

R6 is used as a pullup resistor for the ALERT pin, which is routed to J2 and J3. LED D2 and current limiting resistor R5 are used to indicate when the ALERT has triggered.

6 Schematics, PCB Layout, and Bill of Materials

Note

Board layouts are not to scale. These figures are intended to show how the board is laid out. The figures are not intended to be used for manufacturing EVM PCBs.

6.1 Schematics

This section shows the schematics separately for the SENS063 and SENS064

6.1.1 SENS063 (INA228EVM, INA237EVM, INA238EVM)

Figure 6-1 and Figure 6-2 show the schematic of the EVM. Figure 6-1 shows the circuitry for the EVM. Figure 6-2 shows the mechanical components included with the EVM.

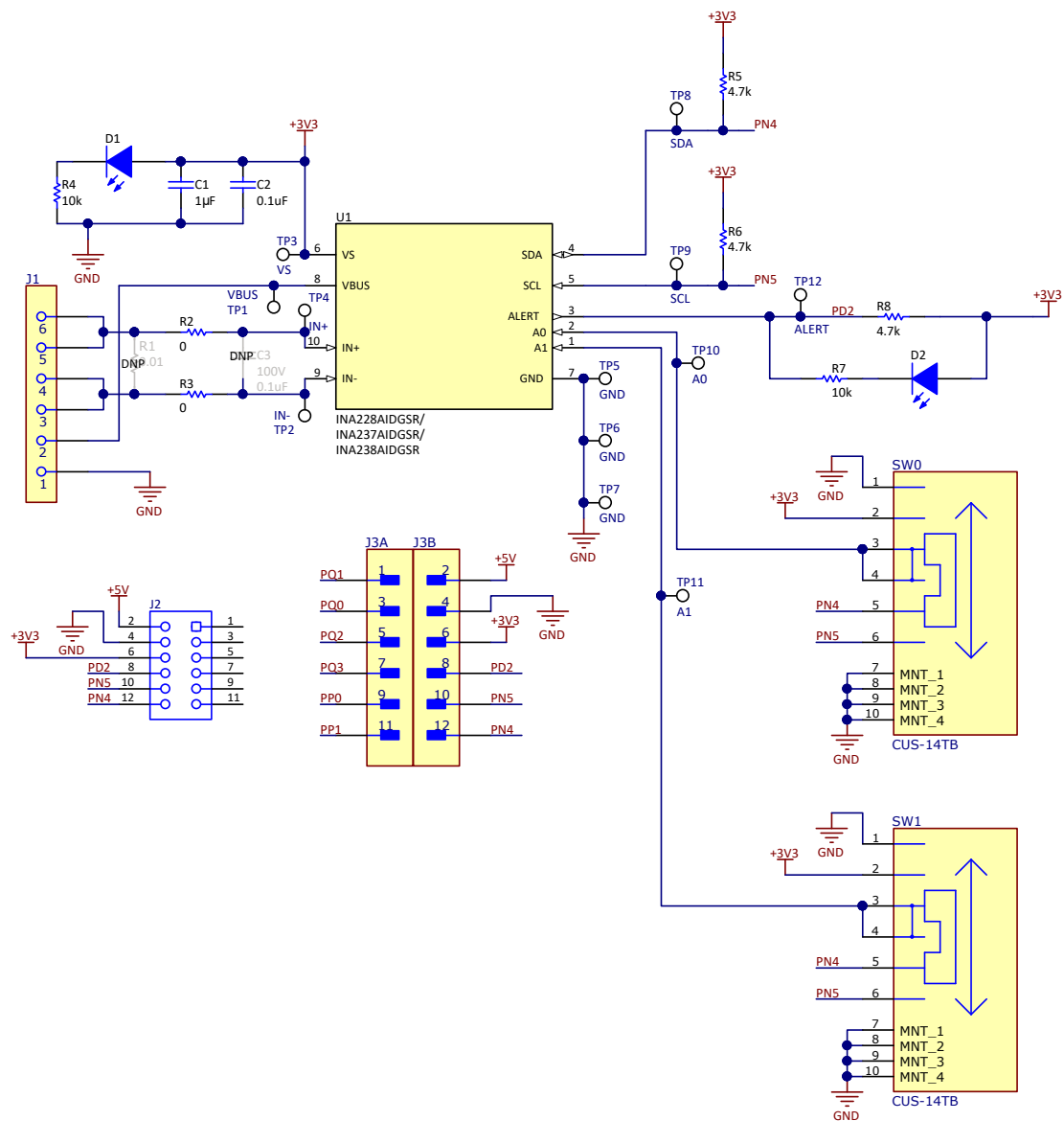

Figure 6-1. SENS063 Schematic



PCB Number: SENS063
PCB Rev: B

PCB LOGO
Texas Instruments



PCB LOGO
FCC disclaimer

PCB LOGO
WEEE logo



LBL1
PCB Label
THT-14-423-10
Size: 0.65" x 0.20 "

ZZ1
Label Assembly Note
This Assembly Note is for PCB labels only

Variant/Label Table	
Variant	Label Text
001	INA228EVM
002	INA237EVM
003	INA238EVM

ZZ2
Assembly Note
These assemblies are ESD sensitive, ESD precautions shall be observed.

ZZ3
Assembly Note
These assemblies must be clean and free from flux and all contaminants. Use of no clean flux is not acceptable.

ZZ4
Assembly Note
These assemblies must comply with workmanship standards IPC-A-610 Class 2, unless otherwise specified.

ZZ5
Assembly Note
Trim the leads under J1 (back of PCB) to give clearance from surface

Figure 6-2. SENS063 Hardware Schematic

6.1.2 SENS064 (INA229EVM, INA239EVM)

Figure 6-3 and Figure 6-4 show the schematic of the EVM. Figure 6-3 shows the circuitry for the EVM. Figure 6-4 shows the mechanical components included with the EVM.

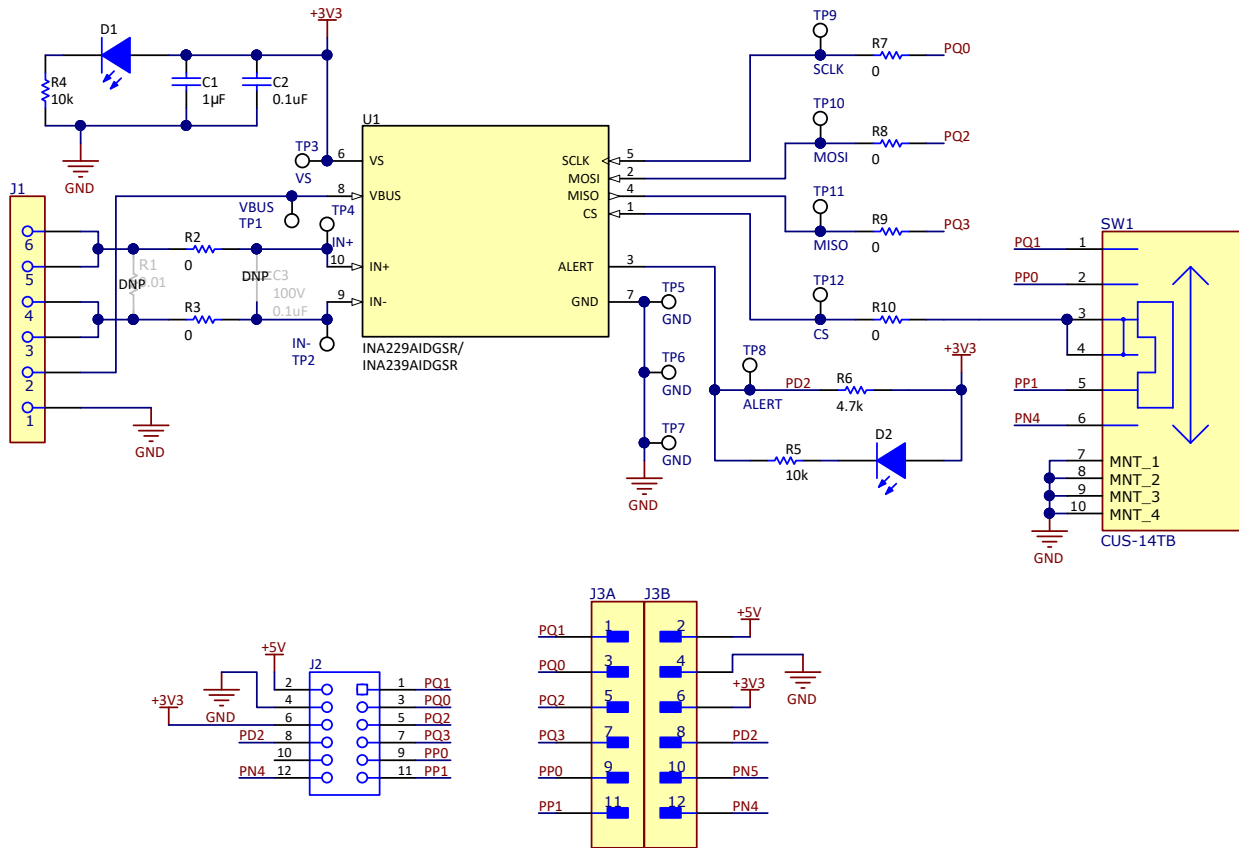

Figure 6-3. SENS064 Schematic



PCB Number: SENS064
PCB Rev: B

PCB LOGO
Texas Instruments



PCB LOGO
FCC disclaimer

PCB LOGO
WEEE logo



DANGER HIGH VOLTAGE



CAUTION HOT SURFACE

LBL1
PCB Label
THT-14-423-10
Size: 0.65" x 0.20 "

ZZ1
Label Assembly Note
This Assembly Note is for PCB labels only

ZZ2
Assembly Note
These assemblies are ESD sensitive, ESD precautions shall be observed.

ZZ3
Assembly Note
These assemblies must be clean and free from flux and all contaminants. Use of no clean flux is not acceptable.

ZZ4
Assembly Note
These assemblies must comply with workmanship standards IPC-A-610 Class 2, unless otherwise specified.

ZZ5
Assembly Note
Trim the leads under J1 (back of PCB) to give clearance from surface

Variant/Label Table	
Variant	Label Text
001	INA229EVM
002	INA239EVM

Figure 6-4. SENS064 Hardware Schematic

6.2 PCB Layout

6.2.1 SENS063 (INA228EVM, INA237EVM, INA238EVM)

Figure 6-5 through Figure 6-8 illustrate the PCB layers of the EVM.

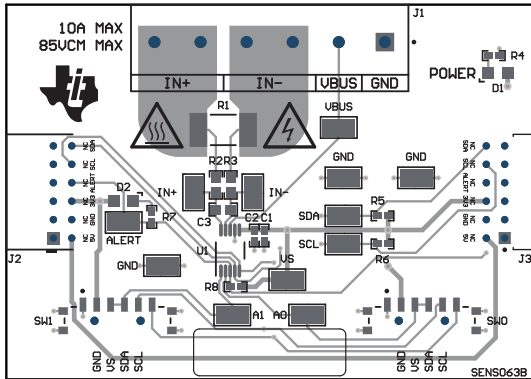

Figure 6-5. SENS063 Top View

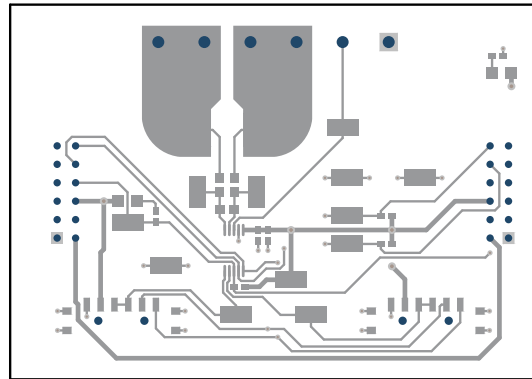

Figure 6-6. SENS063 Top Layer

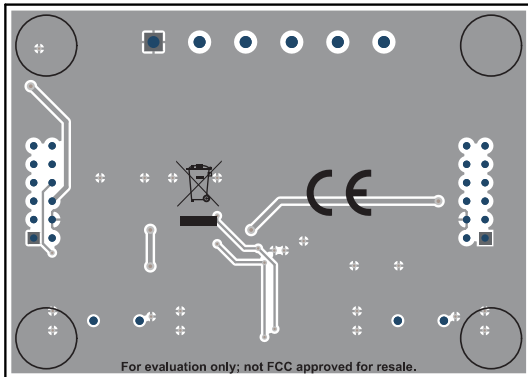

Figure 6-7. SENS063 Bottom View

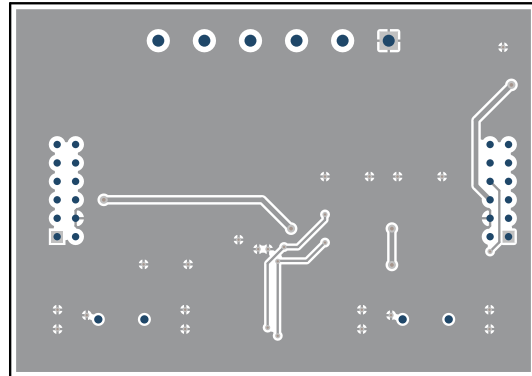

Figure 6-8. SENS063 Bottom Layer

6.2.2 SENS064 (INA229EVM, INA239EVM)

Figure 6-9 through Figure 6-12 illustrate the PCB layers of the EVM.

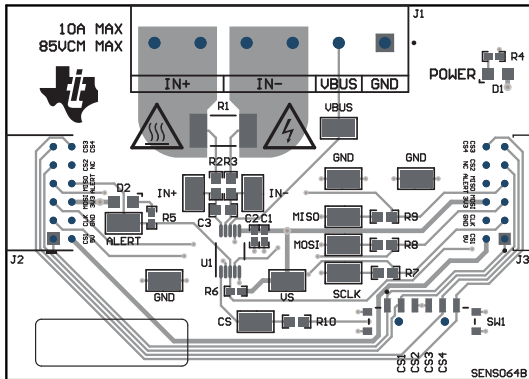

Figure 6-9. SENS064 Top View

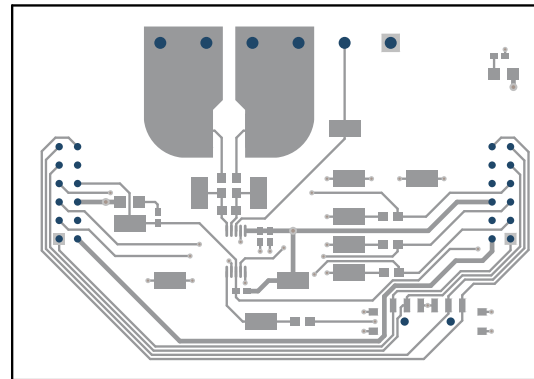

Figure 6-10. SENS064 Top Layer

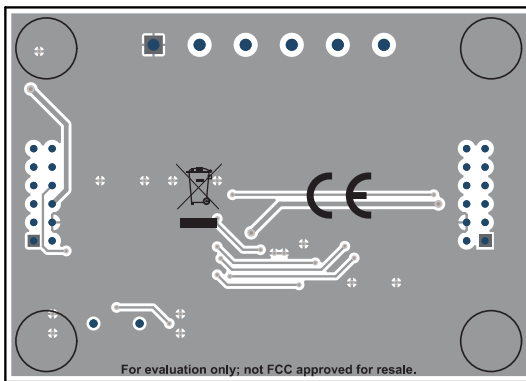

Figure 6-11. SENS064 Bottom View

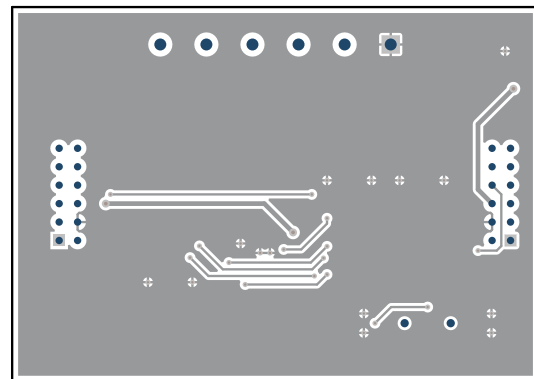

Figure 6-12. SENS064 Bottom Layer

6.3 Bill of Materials

This section shows the bill of materials separately for the SENS063 and SENS064

6.3.1 SENS063 (INA228EVM, INA237EVM, INA238EVM)

Table 6-1 through Table 6-4 provide the parts list for the EVM. Table 6-1 through Table 6-3 are variant specific, while Table 6-4 shows the parts common to all SENS063 variants.

Table 6-1. INA228EVM Exclusive Bill of Materials

Designator	QTY	Value	Description	Package Reference	Part Number	Manufacturer
U1	1		85-V, High-Voltage, Zero-Drift, 20-Bit ADC, I2C, Bidirectional Shunt Current, Bus Voltage, Power, Temperature, Energy and Charge Monitor, DGS0010A (VSSOP-10)	DGS0010A	INA228AIDGSR	Texas Instruments

Table 6-2. INA237EVM Exclusive Bill of Materials

Designator	QTY	Value	Description	Package Reference	Part Number	Manufacturer
U1	1		85-V, High-Voltage, Zero-Drift, 16-Bit ADC, I 2C, Bidirectional Shunt Current, Bus Voltage, Power, and Temperature Monitor	DGS0010A	INA237AIDGSR	Texas Instruments

Table 6-3. INA238EVM Exclusive Bill of Materials

Designator	QTY	Value	Description	Package Reference	Part Number	Manufacturer
U1	1		85-V, High-Voltage, Zero-Drift, 16-Bit ADC, I 2C, Bidirectional Shunt Current, Bus Voltage, Power, and Temperature Monitor	DGS0010A	INA238AIDGSR	Texas Instruments

Table 6-4. SENS063 Variants Bill of Materials

Designator	QTY	Value	Description	Package Reference	Part Number	Manufacturer
!PCB1	1		Printed Circuit Board		SENS063	Any
C1	1	1uF	CAP, CERM, 1 μF, 16 V,+/- 20%, X5R, 0402	0402	GRM155R61C105MA12D	MuRata
C2	1	0.1uF	CAP, CERM, 0.1 uF, 50 V, +/- 20%, X7R, 0402	0402	GRM155R71H104ME14D	MuRata
D1, D2	2	White	LED, White, SMD	0805	VAOL-S8WR4	Visual Communications Company, LLC
H1, H2, H3, H4	4		Bumpon, Hemisphere, 0.25 X 0.075, Clear	75x250 mil	SJ5382	3M
J1	1		TERM BLK 6POS SIDE ENTRY 5MM PCBASSEMBLY NOTE: Trim leads per ZZ5	HDR6	691137710006	Würth Electronics
J2	1		Receptacle, 2mm, 6x2, Gold, R/A, TH	Receptacle, 2mm, 6x2, R/A, TH	NPPN062FJFN-RC	Sullins Connector Solutions
J3	1		'Connector Header Through Hole, Right Angle 12 position 0.079" (2.00mm)	HDR12	NRPN062PARN-RC	Sullins Connector Solutions
LBL1	1		Thermal Transfer Printable Labels, 0.650" W x 0.200" H - 10,000 per roll	PCB Label 0.650 x 0.200 inch	THT-14-423-10	Brady
R2, R3	2	0	RES, 0, 5%, 0.125 W, 0603	0603	MCT06030Z0000ZP500	Vishay/Beyschlag
R4, R7	2	10k	RES, 10 k, 5%, 0.063 W, AEC-Q200 Grade 0, 0402	0402	CRCW040210K0JNED	Vishay-Dale
R5, R6, R8	3	4.7k	RES, 4.7 k, 5%, 0.063 W, AEC-Q200 Grade 0, 0402	0402	CRCW04024K70JNED	Vishay-Dale
SW0, SW1	2		Slide Switch SP4T Surface Mount, Right Angle	SMT_SW_11MM3_4MM1	CUS-14TB	Nidec Copal Electronics

Table 6-4. SENS063 Variants Bill of Materials (continued)

Designator	QTY	Value	Description	Package Reference	Part Number	Manufacturer
TP1, TP2, TP3, TP4, TP5, TP6, TP7, TP8, TP9, TP10, TP11, TP12	12		Test Point, Miniature, SMT	Testpoint_Keystone_Miniatu re	5015	Keystone
C3	0	0.1uF	CAP, CERM, 0.1 uF, 100 V, +/- 10%, X7S, AEC-Q200 Grade 1, 0603	0603	CGA3E3X7S2A104K080AB	TDK
FID1, FID2, FID3	0		Fiducial mark. There is nothing to buy or mount.	N/A	N/A	N/A
R1	0		10 mOhms ±0.5% 2W Chip Resistor 2512 (6432 Metric) Automotive AEC-Q200, Current Sense, Moisture Resistant Metal Film	2512	PCS2512DR0100ET	Ohmite

6.3.2 SENS064 (INA229EVM, INA239EVM)

Table 6-5 through Table 6-7 provide the parts list for the EVM. Table 6-5 and Table 6-6 are variant specific, while Table 6-7 shows the parts common to all SENS064 variants.

Table 6-5. INA229EVM Exclusive Bill of Materials

Designator	QTY	Value	Description	Package Reference	Part Number	Manufacturer
U1	1		85-V, High-Voltage, Zero-Drift, 20-Bit ADC, SPI, Bidirectional Shunt Current, Bus Voltage, Power, and Temperature, Energy and Charge Monitor, DGS0010A (VSSOP-10)	DGS0010A	INA229AIDGSR	Texas Instruments

Table 6-6. INA239EVM Exclusive Bill of Materials

Designator	QTY	Value	Description	Package Reference	Part Number	Manufacturer
U1	1		85-V, High-Voltage, Zero-Drift, 16-Bit ADC, SPI, Bidirectional Shunt Current, Bus Voltage, Power, and Temperature Monitor	DGS0010A	INA239AIDGSR	Texas Instruments

Table 6-7. SENS046 Variants Bill of Materials

Designator	QTY	Value	Description	Package Reference	Part Number	Manufacturer
!PCB1	1		Printed Circuit Board		SENS064	Any
C1	1	1uF	CAP, CERM, 1 uF, 16 V, +/- 20%, X5R, 0402	0402	GRM155R61C105MA12D	MuRata
C2	1	0.1uF	CAP, CERM, 0.1 uF, 50 V, +/- 20%, X7R, 0402	0402	GRM155R71H104ME14D	MuRata
D1, D2	2	White	LED, White, SMD	0805	VAOL-S8WR4	Visual Communications Company, LLC
H1, H2, H3, H4	4		Bumpon, Hemisphere, 0.25 X 0.075, Clear	75x250 mil	SJ5382	3M
J1	1		TERM BLK 6POS SIDE ENTRY 5MM PCBASSEMBLY NOTE: Trim leads per ZZ5	HDR6	691137710006	Würth Electronics
J2	1		Receptacle, 2mm, 6x2, Gold, R/A, TH	Receptacle, 2mm, 6x2, R/A, TH	NPPN062FJFN-RC	Sullins Connector Solutions
J3	1		Connector Header Through Hole, Right Angle 12 position 0.079" (2.00mm)	HDR12	NRPN062PARN-RC	Sullins Connector Solutions
LBL1	1		Thermal Transfer Printable Labels, 0.650" W x 0.200" H - 10,000 per roll	PCB Label 0.650 x 0.200 inch	THT-14-423-10	Brady
R2, R3, R7, R8, R9, R10	6	0	RES, 0, 5%, 0.125 W, 0603	0603	MCT06030Z0000ZP500	Vishay/Beyschlag

Table 6-7. SENS046 Variants Bill of Materials (continued)

Designator	QTY	Value	Description	Package Reference	Part Number	Manufacturer
R4, R5	2	10k	RES, 10 k, 5%, 0.063 W, AEC-Q200 Grade 0, 0402	0402	CRCW040210K0JNED	Vishay-Dale
R6	1	4.7k	RES, 4.7 k, 5%, 0.063 W, AEC-Q200 Grade 0, 0402	0402	CRCW04024K70JNED	Vishay-Dale
SW1	1		Slide Switch SP4T Surface Mount, Right Angle	SMT_SW_11MM3_4MM1	CUS-14TB	Nidec Copal Electronics
TP1, TP2, TP3, TP4, TP5, TP6, TP7, TP8, TP9, TP10, TP11, TP12	12		Test Point, Miniature, SMT	Testpoint_Keystone_Miniature	5015	Keystone
C3	0	0.1uF	CAP, CERM, 0.1 uF, 100 V, +/- 10%, X7S, AEC-Q200 Grade 1, 0603	0603	CGA3E3X7S2A104K080AB	TDK
FID1, FID2, FID3	0		Fiducial mark. There is nothing to buy or mount.	N/A	N/A	N/A
R1	0		10 mOhms ±0.5% 2W Chip Resistor 2512 (6432 Metric) Automotive AEC-Q200, Current Sense, Moisture Resistant Metal Film	2512	PCS2512DR0100ET	Ohmite

7 Revision History

NOTE: Page numbers for previous revisions may differ from page numbers in the current version.

Changes from Revision D (February 2022) to Revision E (August 2022)	Page
<ul style="list-style-type: none"> Changed GUI hyperlinks throughout document..... 	7
Changes from Revision C (July 2021) to Revision D (February 2022)	Page
<ul style="list-style-type: none"> Removed SCB as a kitted item..... 	5
Changes from Revision B (December 2020) to Revision C (July 2021)	Page
<ul style="list-style-type: none"> Updated GUI setup and operation instructions after software update..... 	5
Changes from Revision A (June 2020) to Revision B (December 2020)	Page
<ul style="list-style-type: none"> Updated from preview EVM to full production EVM..... Updated the numbering format for tables, figures, and cross-references throughout the document..... 	1 5
Changes from Revision * (April 2020) to Revision A (June 2020)	Page
<ul style="list-style-type: none"> Updated document to add support for the INA228EVM, INA237EVM, and INA238EVM..... Added Direct EVM Serial Communication section to explain how to communicate with the EVM via direct serial communication..... 	1 18

STANDARD TERMS FOR EVALUATION MODULES

1. *Delivery:* TI delivers TI evaluation boards, kits, or modules, including any accompanying demonstration software, components, and/or documentation which may be provided together or separately (collectively, an "EVM" or "EVMs") to the User ("User") in accordance with the terms set forth herein. User's acceptance of the EVM is expressly subject to the following terms.
 - 1.1 EVMs are intended solely for product or software developers for use in a research and development setting to facilitate feasibility evaluation, experimentation, or scientific analysis of TI semiconductors products. EVMs have no direct function and are not finished products. EVMs shall not be directly or indirectly assembled as a part or subassembly in any finished product. For clarification, any software or software tools provided with the EVM ("Software") shall not be subject to the terms and conditions set forth herein but rather shall be subject to the applicable terms that accompany such Software
 - 1.2 EVMs are not intended for consumer or household use. EVMs may not be sold, sublicensed, leased, rented, loaned, assigned, or otherwise distributed for commercial purposes by Users, in whole or in part, or used in any finished product or production system.
2. *Limited Warranty and Related Remedies/Disclaimers:*
 - 2.1 These terms do not apply to Software. The warranty, if any, for Software is covered in the applicable Software License Agreement.
 - 2.2 TI warrants that the TI EVM will conform to TI's published specifications for ninety (90) days after the date TI delivers such EVM to User. Notwithstanding the foregoing, TI shall not be liable for a nonconforming EVM if (a) the nonconformity was caused by neglect, misuse or mistreatment by an entity other than TI, including improper installation or testing, or for any EVMs that have been altered or modified in any way by an entity other than TI, (b) the nonconformity resulted from User's design, specifications or instructions for such EVMs or improper system design, or (c) User has not paid on time. Testing and other quality control techniques are used to the extent TI deems necessary. TI does not test all parameters of each EVM. User's claims against TI under this Section 2 are void if User fails to notify TI of any apparent defects in the EVMs within ten (10) business days after delivery, or of any hidden defects with ten (10) business days after the defect has been detected.
 - 2.3 TI's sole liability shall be at its option to repair or replace EVMs that fail to conform to the warranty set forth above, or credit User's account for such EVM. TI's liability under this warranty shall be limited to EVMs that are returned during the warranty period to the address designated by TI and that are determined by TI not to conform to such warranty. If TI elects to repair or replace such EVM, TI shall have a reasonable time to repair such EVM or provide replacements. Repaired EVMs shall be warranted for the remainder of the original warranty period. Replaced EVMs shall be warranted for a new full ninety (90) day warranty period.

WARNING

Evaluation Kits are intended solely for use by technically qualified, professional electronics experts who are familiar with the dangers and application risks associated with handling electrical mechanical components, systems, and subsystems.

User shall operate the Evaluation Kit within TI's recommended guidelines and any applicable legal or environmental requirements as well as reasonable and customary safeguards. Failure to set up and/or operate the Evaluation Kit within TI's recommended guidelines may result in personal injury or death or property damage. Proper set up entails following TI's instructions for electrical ratings of interface circuits such as input, output and electrical loads.

NOTE:

EXPOSURE TO ELECTROSTATIC DISCHARGE (ESD) MAY CAUSE DEGRADATION OR FAILURE OF THE EVALUATION KIT; TI RECOMMENDS STORAGE OF THE EVALUATION KIT IN A PROTECTIVE ESD BAG.

3 Regulatory Notices:

3.1 United States

3.1.1 Notice applicable to EVMs not FCC-Approved:

FCC NOTICE: This kit is designed to allow product developers to evaluate electronic components, circuitry, or software associated with the kit to determine whether to incorporate such items in a finished product and software developers to write software applications for use with the end product. This kit is not a finished product and when assembled may not be resold or otherwise marketed unless all required FCC equipment authorizations are first obtained. Operation is subject to the condition that this product not cause harmful interference to licensed radio stations and that this product accept harmful interference. Unless the assembled kit is designed to operate under part 15, part 18 or part 95 of this chapter, the operator of the kit must operate under the authority of an FCC license holder or must secure an experimental authorization under part 5 of this chapter.

3.1.2 For EVMs annotated as FCC – FEDERAL COMMUNICATIONS COMMISSION Part 15 Compliant:

CAUTION

This device complies with part 15 of the FCC Rules. Operation is subject to the following two conditions: (1) This device may not cause harmful interference, and (2) this device must accept any interference received, including interference that may cause undesired operation.

Changes or modifications not expressly approved by the party responsible for compliance could void the user's authority to operate the equipment.

FCC Interference Statement for Class A EVM devices

NOTE: This equipment has been tested and found to comply with the limits for a Class A digital device, pursuant to part 15 of the FCC Rules. These limits are designed to provide reasonable protection against harmful interference when the equipment is operated in a commercial environment. This equipment generates, uses, and can radiate radio frequency energy and, if not installed and used in accordance with the instruction manual, may cause harmful interference to radio communications. Operation of this equipment in a residential area is likely to cause harmful interference in which case the user will be required to correct the interference at his own expense.

FCC Interference Statement for Class B EVM devices

NOTE: This equipment has been tested and found to comply with the limits for a Class B digital device, pursuant to part 15 of the FCC Rules. These limits are designed to provide reasonable protection against harmful interference in a residential installation. This equipment generates, uses and can radiate radio frequency energy and, if not installed and used in accordance with the instructions, may cause harmful interference to radio communications. However, there is no guarantee that interference will not occur in a particular installation. If this equipment does cause harmful interference to radio or television reception, which can be determined by turning the equipment off and on, the user is encouraged to try to correct the interference by one or more of the following measures:

- Reorient or relocate the receiving antenna.
- Increase the separation between the equipment and receiver.
- Connect the equipment into an outlet on a circuit different from that to which the receiver is connected.
- Consult the dealer or an experienced radio/TV technician for help.

3.2 Canada

3.2.1 For EVMs issued with an Industry Canada Certificate of Conformance to RSS-210 or RSS-247

Concerning EVMs Including Radio Transmitters:

This device complies with Industry Canada license-exempt RSSs. Operation is subject to the following two conditions:

(1) this device may not cause interference, and (2) this device must accept any interference, including interference that may cause undesired operation of the device.

Concernant les EVMs avec appareils radio:

Le présent appareil est conforme aux CNR d'Industrie Canada applicables aux appareils radio exempts de licence. L'exploitation est autorisée aux deux conditions suivantes: (1) l'appareil ne doit pas produire de brouillage, et (2) l'utilisateur de l'appareil doit accepter tout brouillage radioélectrique subi, même si le brouillage est susceptible d'en compromettre le fonctionnement.

Concerning EVMs Including Detachable Antennas:

Under Industry Canada regulations, this radio transmitter may only operate using an antenna of a type and maximum (or lesser) gain approved for the transmitter by Industry Canada. To reduce potential radio interference to other users, the antenna type and its gain should be so chosen that the equivalent isotropically radiated power (e.i.r.p.) is not more than that necessary for successful communication. This radio transmitter has been approved by Industry Canada to operate with the antenna types listed in the user guide with the maximum permissible gain and required antenna impedance for each antenna type indicated. Antenna types not included in this list, having a gain greater than the maximum gain indicated for that type, are strictly prohibited for use with this device.

Concernant les EVMs avec antennes détachables

Conformément à la réglementation d'Industrie Canada, le présent émetteur radio peut fonctionner avec une antenne d'un type et d'un gain maximal (ou inférieur) approuvé pour l'émetteur par Industrie Canada. Dans le but de réduire les risques de brouillage radioélectrique à l'intention des autres utilisateurs, il faut choisir le type d'antenne et son gain de sorte que la puissance isotrope rayonnée équivalente (p.i.r.e.) ne dépasse pas l'intensité nécessaire à l'établissement d'une communication satisfaisante. Le présent émetteur radio a été approuvé par Industrie Canada pour fonctionner avec les types d'antenne énumérés dans le manuel d'usage et ayant un gain admissible maximal et l'impédance requise pour chaque type d'antenne. Les types d'antenne non inclus dans cette liste, ou dont le gain est supérieur au gain maximal indiqué, sont strictement interdits pour l'exploitation de l'émetteur.

3.3 Japan

3.3.1 *Notice for EVMs delivered in Japan:* Please see http://www.tij.co.jp/lstds/ti_ja/general/eStore/notice_01.page 日本国内に輸入される評価用キット、ボードについては、次のところをご覧ください。
http://www.tij.co.jp/lstds/ti_ja/general/eStore/notice_01.page

3.3.2 *Notice for Users of EVMs Considered "Radio Frequency Products" in Japan:* EVMs entering Japan may not be certified by TI as conforming to Technical Regulations of Radio Law of Japan.

If User uses EVMs in Japan, not certified to Technical Regulations of Radio Law of Japan, User is required to follow the instructions set forth by Radio Law of Japan, which includes, but is not limited to, the instructions below with respect to EVMs (which for the avoidance of doubt are stated strictly for convenience and should be verified by User):

1. Use EVMs in a shielded room or any other test facility as defined in the notification #173 issued by Ministry of Internal Affairs and Communications on March 28, 2006, based on Sub-section 1.1 of Article 6 of the Ministry's Rule for Enforcement of Radio Law of Japan,
2. Use EVMs only after User obtains the license of Test Radio Station as provided in Radio Law of Japan with respect to EVMs, or
3. Use of EVMs only after User obtains the Technical Regulations Conformity Certification as provided in Radio Law of Japan with respect to EVMs. Also, do not transfer EVMs, unless User gives the same notice above to the transferee. Please note that if User does not follow the instructions above, User will be subject to penalties of Radio Law of Japan.

【無線電波を送信する製品の開発キットをお使いになる際の注意事項】 開発キットの中には技術基準適合証明を受けていないものがあります。技術適合証明を受けていないものご使用に際しては、電波法遵守のため、以下のいずれかの措置を取っていただく必要がありますのでご注意ください。

1. 電波法施行規則第6条第1項第1号に基づく平成18年3月28日総務省告示第173号で定められた電波暗室等の試験設備でご使用いただく。
2. 実験局の免許を取得後ご使用いただく。
3. 技術基準適合証明を取得後ご使用いただく。

なお、本製品は、上記の「ご使用にあたっての注意」を譲渡先、移転先に通知しない限り、譲渡、移転できないものとします。

上記を遵守頂けない場合は、電波法の罰則が適用される可能性があることをご留意ください。日本テキサス・インスツルメンツ株式会社
東京都新宿区西新宿 6 丁目 2 4 番 1 号
西新宿三井ビル

3.3.3 *Notice for EVMs for Power Line Communication:* Please see http://www.tij.co.jp/lstds/ti_ja/general/eStore/notice_02.page 電力線搬送波通信についての開発キットをお使いになる際の注意事項については、次のところをご覧ください。
http://www.tij.co.jp/lstds/ti_ja/general/eStore/notice_02.page

3.4 European Union

3.4.1 *For EVMs subject to EU Directive 2014/30/EU (Electromagnetic Compatibility Directive):*

This is a class A product intended for use in environments other than domestic environments that are connected to a low-voltage power-supply network that supplies buildings used for domestic purposes. In a domestic environment this product may cause radio interference in which case the user may be required to take adequate measures.

-
- 4 *EVM Use Restrictions and Warnings:*
 - 4.1 EVMS ARE NOT FOR USE IN FUNCTIONAL SAFETY AND/OR SAFETY CRITICAL EVALUATIONS, INCLUDING BUT NOT LIMITED TO EVALUATIONS OF LIFE SUPPORT APPLICATIONS.
 - 4.2 User must read and apply the user guide and other available documentation provided by TI regarding the EVM prior to handling or using the EVM, including without limitation any warning or restriction notices. The notices contain important safety information related to, for example, temperatures and voltages.
 - 4.3 *Safety-Related Warnings and Restrictions:*
 - 4.3.1 User shall operate the EVM within TI's recommended specifications and environmental considerations stated in the user guide, other available documentation provided by TI, and any other applicable requirements and employ reasonable and customary safeguards. Exceeding the specified performance ratings and specifications (including but not limited to input and output voltage, current, power, and environmental ranges) for the EVM may cause personal injury or death, or property damage. If there are questions concerning performance ratings and specifications, User should contact a TI field representative prior to connecting interface electronics including input power and intended loads. Any loads applied outside of the specified output range may also result in unintended and/or inaccurate operation and/or possible permanent damage to the EVM and/or interface electronics. Please consult the EVM user guide prior to connecting any load to the EVM output. If there is uncertainty as to the load specification, please contact a TI field representative. During normal operation, even with the inputs and outputs kept within the specified allowable ranges, some circuit components may have elevated case temperatures. These components include but are not limited to linear regulators, switching transistors, pass transistors, current sense resistors, and heat sinks, which can be identified using the information in the associated documentation. When working with the EVM, please be aware that the EVM may become very warm.
 - 4.3.2 EVMs are intended solely for use by technically qualified, professional electronics experts who are familiar with the dangers and application risks associated with handling electrical mechanical components, systems, and subsystems. User assumes all responsibility and liability for proper and safe handling and use of the EVM by User or its employees, affiliates, contractors or designees. User assumes all responsibility and liability to ensure that any interfaces (electronic and/or mechanical) between the EVM and any human body are designed with suitable isolation and means to safely limit accessible leakage currents to minimize the risk of electrical shock hazard. User assumes all responsibility and liability for any improper or unsafe handling or use of the EVM by User or its employees, affiliates, contractors or designees.
 - 4.4 User assumes all responsibility and liability to determine whether the EVM is subject to any applicable international, federal, state, or local laws and regulations related to User's handling and use of the EVM and, if applicable, User assumes all responsibility and liability for compliance in all respects with such laws and regulations. User assumes all responsibility and liability for proper disposal and recycling of the EVM consistent with all applicable international, federal, state, and local requirements.
 5. *Accuracy of Information:* To the extent TI provides information on the availability and function of EVMs, TI attempts to be as accurate as possible. However, TI does not warrant the accuracy of EVM descriptions, EVM availability or other information on its websites as accurate, complete, reliable, current, or error-free.
 6. *Disclaimers:*
 - 6.1 EXCEPT AS SET FORTH ABOVE, EVMS AND ANY MATERIALS PROVIDED WITH THE EVM (INCLUDING, BUT NOT LIMITED TO, REFERENCE DESIGNS AND THE DESIGN OF THE EVM ITSELF) ARE PROVIDED "AS IS" AND "WITH ALL FAULTS." TI DISCLAIMS ALL OTHER WARRANTIES, EXPRESS OR IMPLIED, REGARDING SUCH ITEMS, INCLUDING BUT NOT LIMITED TO ANY EPIDEMIC FAILURE WARRANTY OR IMPLIED WARRANTIES OF MERCHANTABILITY OR FITNESS FOR A PARTICULAR PURPOSE OR NON-INFRINGEMENT OF ANY THIRD PARTY PATENTS, COPYRIGHTS, TRADE SECRETS OR OTHER INTELLECTUAL PROPERTY RIGHTS.
 - 6.2 EXCEPT FOR THE LIMITED RIGHT TO USE THE EVM SET FORTH HEREIN, NOTHING IN THESE TERMS SHALL BE CONSTRUED AS GRANTING OR CONFERRING ANY RIGHTS BY LICENSE, PATENT, OR ANY OTHER INDUSTRIAL OR INTELLECTUAL PROPERTY RIGHT OF TI, ITS SUPPLIERS/LICENSORS OR ANY OTHER THIRD PARTY, TO USE THE EVM IN ANY FINISHED END-USER OR READY-TO-USE FINAL PRODUCT, OR FOR ANY INVENTION, DISCOVERY OR IMPROVEMENT, REGARDLESS OF WHEN MADE, CONCEIVED OR ACQUIRED.
 7. *USER'S INDEMNITY OBLIGATIONS AND REPRESENTATIONS.* USER WILL DEFEND, INDEMNIFY AND HOLD TI, ITS LICENSORS AND THEIR REPRESENTATIVES HARMLESS FROM AND AGAINST ANY AND ALL CLAIMS, DAMAGES, LOSSES, EXPENSES, COSTS AND LIABILITIES (COLLECTIVELY, "CLAIMS") ARISING OUT OF OR IN CONNECTION WITH ANY HANDLING OR USE OF THE EVM THAT IS NOT IN ACCORDANCE WITH THESE TERMS. THIS OBLIGATION SHALL APPLY WHETHER CLAIMS ARISE UNDER STATUTE, REGULATION, OR THE LAW OF TORT, CONTRACT OR ANY OTHER LEGAL THEORY, AND EVEN IF THE EVM FAILS TO PERFORM AS DESCRIBED OR EXPECTED.
-

8. *Limitations on Damages and Liability:*

8.1 *General Limitations.* IN NO EVENT SHALL TI BE LIABLE FOR ANY SPECIAL, COLLATERAL, INDIRECT, PUNITIVE, INCIDENTAL, CONSEQUENTIAL, OR EXEMPLARY DAMAGES IN CONNECTION WITH OR ARISING OUT OF THESE TERMS OR THE USE OF THE EVMS , REGARDLESS OF WHETHER TI HAS BEEN ADVISED OF THE POSSIBILITY OF SUCH DAMAGES. EXCLUDED DAMAGES INCLUDE, BUT ARE NOT LIMITED TO, COST OF REMOVAL OR REINSTALLATION, ANCILLARY COSTS TO THE PROCUREMENT OF SUBSTITUTE GOODS OR SERVICES, RETESTING, OUTSIDE COMPUTER TIME, LABOR COSTS, LOSS OF GOODWILL, LOSS OF PROFITS, LOSS OF SAVINGS, LOSS OF USE, LOSS OF DATA, OR BUSINESS INTERRUPTION. NO CLAIM, SUIT OR ACTION SHALL BE BROUGHT AGAINST TI MORE THAN TWELVE (12) MONTHS AFTER THE EVENT THAT GAVE RISE TO THE CAUSE OF ACTION HAS OCCURRED.

8.2 *Specific Limitations.* IN NO EVENT SHALL TI'S AGGREGATE LIABILITY FROM ANY USE OF AN EVM PROVIDED HEREUNDER, INCLUDING FROM ANY WARRANTY, INDEMNITY OR OTHER OBLIGATION ARISING OUT OF OR IN CONNECTION WITH THESE TERMS, , EXCEED THE TOTAL AMOUNT PAID TO TI BY USER FOR THE PARTICULAR EVM(S) AT ISSUE DURING THE PRIOR TWELVE (12) MONTHS WITH RESPECT TO WHICH LOSSES OR DAMAGES ARE CLAIMED. THE EXISTENCE OF MORE THAN ONE CLAIM SHALL NOT ENLARGE OR EXTEND THIS LIMIT.

9. *Return Policy.* Except as otherwise provided, TI does not offer any refunds, returns, or exchanges. Furthermore, no return of EVM(s) will be accepted if the package has been opened and no return of the EVM(s) will be accepted if they are damaged or otherwise not in a resalable condition. If User feels it has been incorrectly charged for the EVM(s) it ordered or that delivery violates the applicable order, User should contact TI. All refunds will be made in full within thirty (30) working days from the return of the components(s), excluding any postage or packaging costs.

10. *Governing Law:* These terms and conditions shall be governed by and interpreted in accordance with the laws of the State of Texas, without reference to conflict-of-laws principles. User agrees that non-exclusive jurisdiction for any dispute arising out of or relating to these terms and conditions lies within courts located in the State of Texas and consents to venue in Dallas County, Texas. Notwithstanding the foregoing, any judgment may be enforced in any United States or foreign court, and TI may seek injunctive relief in any United States or foreign court.

Mailing Address: Texas Instruments, Post Office Box 655303, Dallas, Texas 75265
Copyright © 2019, Texas Instruments Incorporated

IMPORTANT NOTICE AND DISCLAIMER

TI PROVIDES TECHNICAL AND RELIABILITY DATA (INCLUDING DATA SHEETS), DESIGN RESOURCES (INCLUDING REFERENCE DESIGNS), APPLICATION OR OTHER DESIGN ADVICE, WEB TOOLS, SAFETY INFORMATION, AND OTHER RESOURCES "AS IS" AND WITH ALL FAULTS, AND DISCLAIMS ALL WARRANTIES, EXPRESS AND IMPLIED, INCLUDING WITHOUT LIMITATION ANY IMPLIED WARRANTIES OF MERCHANTABILITY, FITNESS FOR A PARTICULAR PURPOSE OR NON-INFRINGEMENT OF THIRD PARTY INTELLECTUAL PROPERTY RIGHTS.

These resources are intended for skilled developers designing with TI products. You are solely responsible for (1) selecting the appropriate TI products for your application, (2) designing, validating and testing your application, and (3) ensuring your application meets applicable standards, and any other safety, security, regulatory or other requirements.

These resources are subject to change without notice. TI grants you permission to use these resources only for development of an application that uses the TI products described in the resource. Other reproduction and display of these resources is prohibited. No license is granted to any other TI intellectual property right or to any third party intellectual property right. TI disclaims responsibility for, and you will fully indemnify TI and its representatives against, any claims, damages, costs, losses, and liabilities arising out of your use of these resources.

TI's products are provided subject to [TI's Terms of Sale](#) or other applicable terms available either on ti.com or provided in conjunction with such TI products. TI's provision of these resources does not expand or otherwise alter TI's applicable warranties or warranty disclaimers for TI products.

TI objects to and rejects any additional or different terms you may have proposed.

Mailing Address: Texas Instruments, Post Office Box 655303, Dallas, Texas 75265
Copyright © 2022, Texas Instruments Incorporated