

## 150mA LDO REGULATOR

NO.EA-105-220531

### OUTLINE

The R1180x Series are CMOS-based voltage regulator ICs with high output voltage accuracy, extremely low supply current, and low ON-resistance. Each of these ICs consists of a voltage reference unit, an error amplifier, resistor-net for voltage setting, a current limit circuit which prevents the destruction by excess current, and so on. The output voltage of these ICs is fixed with high accuracy. B version has a chip enable pin, therefore ultra-low consumption current standby mode can be realized with the pin.

Since the packages for these ICs are SOT-23-5 (R1180N Series), SC-82AB (R1180Q Series), and SON1612-6 (R1180D Series), therefore high density mounting of the ICs on boards is possible.

### FEATURES

- Supply Current ..... Typ. 1 $\mu$ A  
(Except the current through CE pull-down circuit)
- Standby Mode ..... Typ. 0.1 $\mu$ A
- Dropout Voltage ..... Typ. 0.25V ( $I_{OUT}=150\text{mA}$  3.0V Output type)
- Temperature-Drift Coefficient of Output Voltage ..... Typ.  $\pm 100\text{ppm}/^\circ\text{C}$
- Line Regulation ..... Typ. 0.05%/V
- Output Voltage Accuracy .....  $\pm 2.0\%$
- Packages ..... SON1612-6, SC-82AB, SOT-23-5
- Output Voltage Range ..... 1.2V to 3.6V (0.1V steps)  
(For other voltages, please refer to MARK INFORMATIONS.)
- Built-in Fold Back Protection Circuit ..... Typ. 40mA (Current at short mode)
- Ceramic capacitors are recommended to be used with this IC ..... 0.1 $\mu$ F

### APPLICATIONS

- Stable voltage reference.
- Power source for electrical appliances such as cameras, VCRs and camcorders.
- Power source for battery-powered equipment.

## BLOCK DIAGRAMS

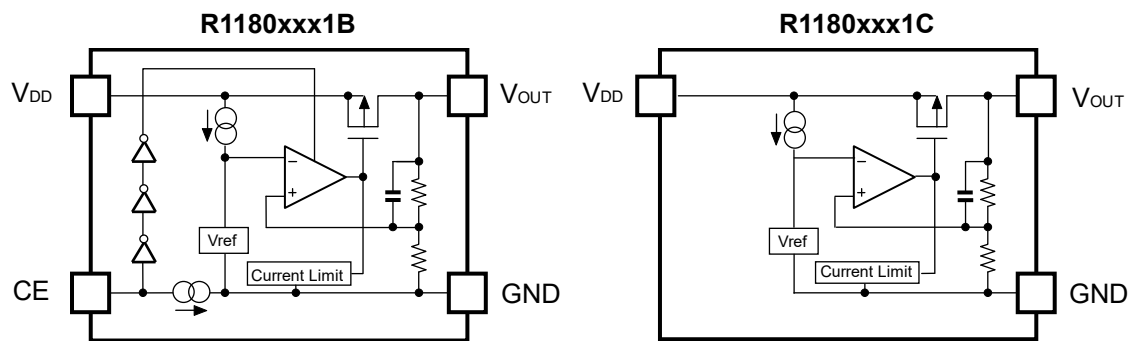

## SELECTION GUIDE

The output voltage, CE pin polarity, package, etc. for the ICs can be selected at the user's request.

Product Name	Package	Quantity per Reel	Pb Free	Halogen Free
R1180Dxx1*-TR-FE	SON1612-6	4,000 pcs	Yes	Yes
R1180Qxx1*-TR-FE	SC-82AB	3,000 pcs	Yes	Yes
R1180Nxx1*-TR-FE	SOT-23-5	3,000 pcs	Yes	Yes

xx: The output voltage can be designated in the range from 1.2V(12) to 3.6V(36) in 0.1V steps.  
(For other voltages, please refer to MARK INFORMATIONS.)

\* : CE pin polarity are options as follows.  
(B) "H" Active  
(C) without CE pin

## PIN CONFIGURATION

### ● SON1612-6

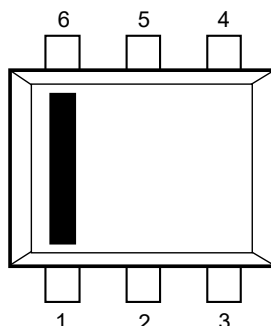

### ● SC-82AB

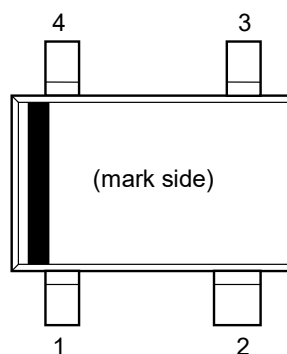

### ● SOT-23-5

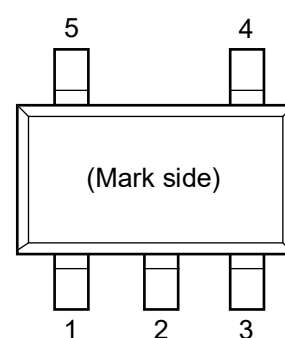

## PIN DESCRIPTIONS

### ● SON1612-6

Pin No	Symbol	Pin Description
1	$V_{DD}$	Input Pin
2	GND	Ground Pin
3	$V_{OUT}$	Output pin
4	NC	No Connection
5	GND	Ground Pin
6	CE or NC	Chip Enable Pin or No Connection

### ● SC-82AB

Pin No	Symbol	Pin Description
1	CE or NC	Chip Enable Pin or No Connection
2	GND	Ground Pin
3	$V_{OUT}$	Output pin
4	$V_{DD}$	Input Pin

### ● SOT-23-5

Pin No	Symbol	Pin Description
1	$V_{DD}$	Input Pin
2	GND	Ground Pin
3	CE or NC	Chip Enable Pin or No Connection
4	NC	No Connection
5	$V_{OUT}$	Output pin

## ABSOLUTE MAXIMUM RATINGS

Symbol	Item	Rating	Unit
$V_{IN}$	Input Voltage	6.5	V
$V_{CE}$	Input Voltage (CE Pin)	6.5	V
$V_{OUT}$	Output Voltage	-0.3 to $V_{IN}+0.3$	V
$I_{OUT}$	Output Current	180	mA
$P_D$	Power Dissipation (SON1612-6)*	500	mW
	Power Dissipation (SC-82AB)*	380	
	Power Dissipation (SOT-23-5)*	420	
$T_{opt}$	Operating Temperature Range	-40 to 85	°C
$T_{stg}$	Storage Temperature Range	-55 to 125	°C

\*) For Power Dissipation, please refer to PACKAGE INFORMATION.

### ABSOLUTE MAXIMUM RATINGS

Electronic and mechanical stress momentarily exceeded absolute maximum ratings may cause the permanent damages and may degrade the life time and safety for both device and system using the device in the field.

The functional operation at or over these absolute maximum ratings is not assured.

### RECOMMENDED OPERATING CONDITIONS (ELECTRICAL CHARACTERISTICS)

All of electronic equipment should be designed that the mounted semiconductor devices operate within the recommended operating conditions. The semiconductor devices cannot operate normally over the recommended operating conditions, even if when they are used over such conditions by momentary electronic noise or surge. And the semiconductor devices may receive serious damage when they continue to operate over the recommended operating conditions.

## ELECTRICAL CHARACTERISTICS

### • R1180xxx1B/C

T<sub>opt</sub>=25°C

Symbol	Item	Conditions	Min.	Typ.	Max.	Unit
V <sub>OUT</sub>	Output Voltage	V <sub>IN</sub> =Set V <sub>OUT</sub> +1V 1μA ≤ I <sub>OUT</sub> ≤ 30mA	×0.980		×1.020	V
I <sub>OUT</sub>	Output Current	V <sub>IN</sub> -V <sub>OUT</sub> =1.0V(V <sub>OUT</sub> ≥ 1.4V) V <sub>IN</sub> =2.4V(V <sub>OUT</sub> <1.4V)	150			mA
ΔV <sub>OUT</sub> /ΔI <sub>OUT</sub>	Load Regulation	V <sub>IN</sub> -V <sub>OUT</sub> =1.0V(V <sub>OUT</sub> ≥ 1.4V) V <sub>IN</sub> =2.4V(V <sub>OUT</sub> <1.4V) 1μA ≤ I <sub>OUT</sub> ≤ 150mA		20	40	mV
V <sub>DIF</sub>	Dropout Voltage	Refer to the ELECTRICAL CHARACTERISTICS by OUTPUT VOLTAGE				
I <sub>SS</sub>	Supply Current	V <sub>IN</sub> -V <sub>OUT</sub> =1.0V, I <sub>OUT</sub> =0mA		1.0	1.5	μA
I <sub>standby</sub>	Supply Current (Standby)	V <sub>IN</sub> -V <sub>OUT</sub> =1.0V, V <sub>CE</sub> =GND		0.1	1.0	μA
ΔV <sub>OUT</sub> /ΔV <sub>IN</sub>	Line Regulation	I <sub>OUT</sub> =30mA V <sub>OUT</sub> +0.5V ≤ V <sub>IN</sub> ≤ 6.0V (V <sub>OUT</sub> ≥ 1.5V) 2.0V ≤ V <sub>IN</sub> ≤ 6.0V (1.2V ≤ V <sub>OUT</sub> ≤ 1.4V)		0.05	0.20	%/V
V <sub>IN</sub>	Input Voltage		1.7		6.0	V
ΔV <sub>OUT</sub> /ΔT <sub>opt</sub>	Output Voltage Temperature Coefficient	I <sub>OUT</sub> =30mA -40°C ≤ T <sub>opt</sub> ≤ 85°C		±100		ppm/°C
I <sub>SC</sub>	Short Current Limit	V <sub>OUT</sub> =0V		40		mA
I <sub>PD</sub>	CE Pull-down Constant Current	(R1180xxx1B)		0.35		μA
V <sub>CEH</sub>	CE Input Voltage "H"	(R1180xxx1B)	1.2		6.0	V
V <sub>CEL</sub>	CE Input Voltage "L"	(R1180xxx1B)	0.0		0.3	V

### • ELECTRICAL CHARACTERISTICS by OUTPUT VOLTAGE

T<sub>opt</sub> = 25°C

Output Voltage V <sub>OUT</sub> (V)	Dropout Voltage V <sub>DIF</sub> (V)		
	Condition	Typ.	Max.
1.2 ≤ V <sub>OUT</sub> < 1.3	I <sub>OUT</sub> =150mA	0.85	1.20
1.3 ≤ V <sub>OUT</sub> < 1.4		0.75	1.10
1.4 ≤ V <sub>OUT</sub> < 1.5		0.65	1.00
1.5 ≤ V <sub>OUT</sub> < 1.7		0.60	0.90
1.7 ≤ V <sub>OUT</sub> < 1.9		0.50	0.75
1.9 ≤ V <sub>OUT</sub> < 2.1		0.40	0.65
2.1 ≤ V <sub>OUT</sub> < 2.8		0.35	0.55
2.8 ≤ V <sub>OUT</sub> ≤ 3.6		0.25	0.40

## TYPICAL APPLICATION

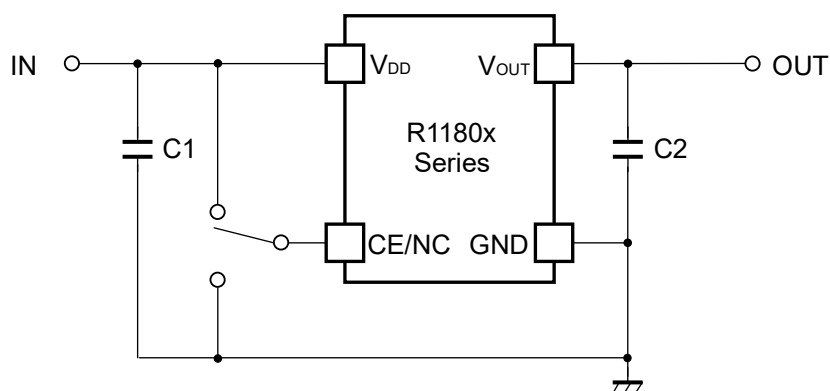

(External Components)

Output Capacitor

Ceramic Capacitor       $0.1\mu\text{F}$

## TECHNICAL NOTES

When using these ICs, consider the following points:

### Phase Compensation

In these ICs, phase compensation is made for securing stable operation even if the load current is varied. For this purpose, use a capacitor C2 with good frequency characteristics and ESR (Equivalent Series Resistance). (Note: If additional ceramic capacitors are connected with parallel to the output pin with an output capacitor for phase compensation, the operation might be unstable. Because of this, test these ICs with as same external components as ones to be used on the PCB.)

### PCB Layout

Make  $V_{DD}$  and GND lines sufficient. If their impedance is high, noise pickup or unstable operation may result. Connect a capacitor C1 with a capacitance value as much as  $0.1\mu\text{F}$  or more between  $V_{DD}$  and GND pin, and as close as possible to the pins.

Set external components, especially the output capacitor C2, as close as possible to the ICs, and make wiring as short as possible.

## PACKAGE INFORMATION

### POWER DISSIPATION (SON1612-6)

Power Dissipation ( $P_D$ ) depends on conditions of mounting on board.

This specification is based on the measurement at the condition below:

#### \* Measurement Conditions

Standard Land Pattern	
Environment	Mounting on Board (Wind velocity 0m/s)
Board Material	Glass cloth epoxy plastic (Double layers)
Board Dimensions	40mm × 40mm × 1.6mm
Copper Ratio	Top side: Approx. 50%, Back side: Approx. 50%
Through - hole	φ 0.5mm × 24pcs

#### \* Measurement Results (Ta=25°C, Tjmax=125°C)

Standard Land Pattern	
Power Dissipation	500mW
Thermal Resistance	$\theta_{ja} = (125-25^\circ\text{C}) / 0.5\text{W} = 200^\circ\text{C/W}$

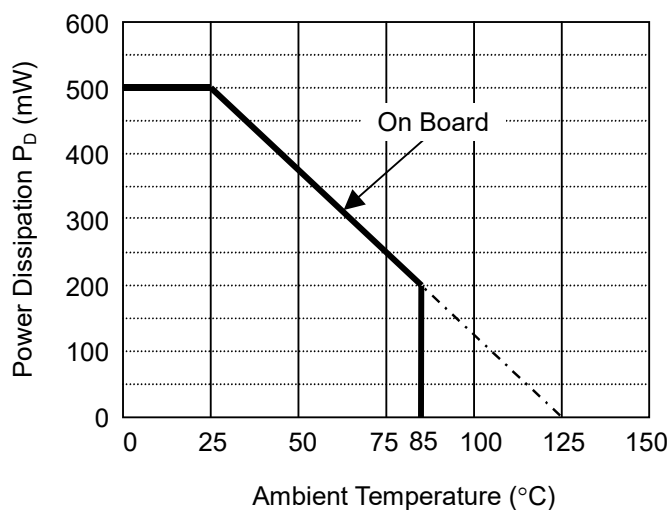

**Power Dissipation**

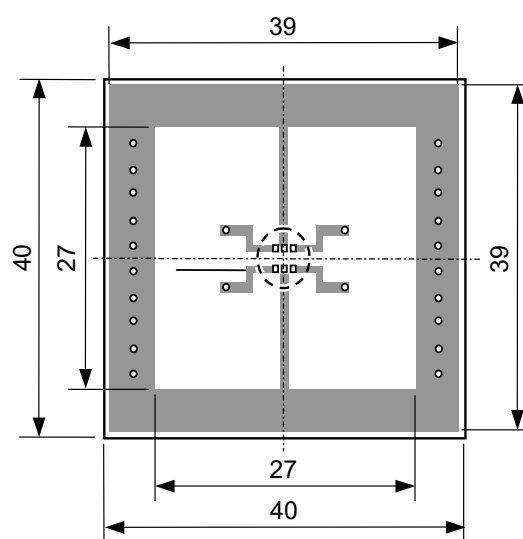

**Measurement Board Pattern**

○ IC Mount Area (Unit: mm)

**PACKAGE DIMENSIONS (SON1612-6)**

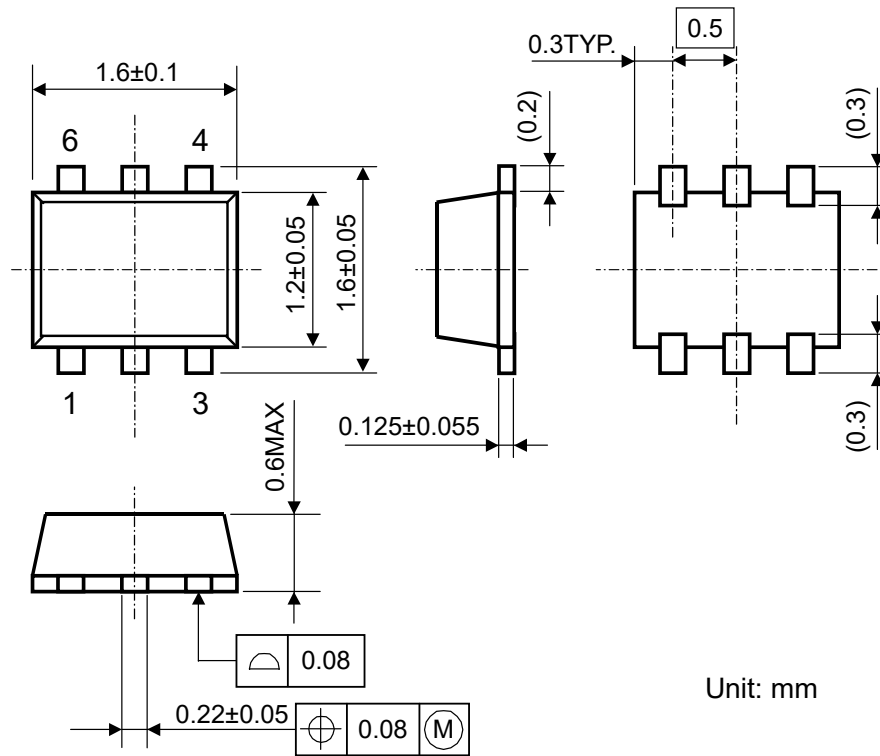

Unit: mm

**MARK SPECIFICATION (SON1612-6)**

- ①②③④ : Product Code ... **Refer to R1180D Series Mark Specification Table**
- ⑤⑥ : Lot Number ... Alphanumeric Serial Number

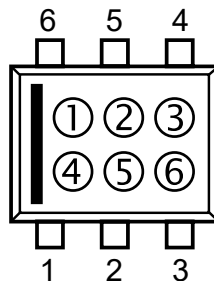



## R1180D MARK SPECIFICATION TABLE (SON1612-6)

R1180Dxx1B Series		R1180Dxx1C Series	
Product Name	①②③④	Product Name	①②③④
R1180D121B	<b>G12B</b>	R1180D121C	<b>G12C</b>
R1180D131B	<b>G13B</b>	R1180D131C	<b>G13C</b>
R1180D141B	<b>G14B</b>	R1180D141C	<b>G14C</b>
R1180D151B	<b>G15B</b>	R1180D151C	<b>G15C</b>
R1180D161B	<b>G16B</b>	R1180D161C	<b>G16C</b>
R1180D171B	<b>G17B</b>	R1180D171C	<b>G17C</b>
R1180D181B	<b>G18B</b>	R1180D181C	<b>G18C</b>
R1180D191B	<b>G19B</b>	R1180D191C	<b>G19C</b>
R1180D201B	<b>G20B</b>	R1180D201C	<b>G20C</b>
R1180D211B	<b>G21B</b>	R1180D211C	<b>G21C</b>
R1180D221B	<b>G22B</b>	R1180D221C	<b>G22C</b>
R1180D231B	<b>G23B</b>	R1180D231C	<b>G23C</b>
R1180D241B	<b>G24B</b>	R1180D241C	<b>G24C</b>
R1180D251B	<b>G25B</b>	R1180D251C	<b>G25C</b>
R1180D261B	<b>G26B</b>	R1180D261C	<b>G26C</b>
R1180D271B	<b>G27B</b>	R1180D271C	<b>G27C</b>
R1180D281B	<b>G28B</b>	R1180D281C	<b>G28C</b>
R1180D291B	<b>G29B</b>	R1180D291C	<b>G29C</b>
R1180D301B	<b>G30B</b>	R1180D301C	<b>G30C</b>
R1180D311B	<b>G31B</b>	R1180D311C	<b>G31C</b>
R1180D321B	<b>G32B</b>	R1180D321C	<b>G32C</b>
R1180D331B	<b>G33B</b>	R1180D331C	<b>G33C</b>
R1180D341B	<b>G34B</b>	R1180D341C	<b>G34C</b>
R1180D351B	<b>G35B</b>	R1180D351C	<b>G35C</b>
R1180D361B	<b>G36B</b>	R1180D361C	<b>G36C</b>
R1180D181B5	<b>G00B</b>	R1180D181C5	<b>G00C</b>
R1180D261B5	<b>G01B</b>	R1180D261C5	<b>G01C</b>

**POWER DISSIPATION (SC-82AB)**

Power Dissipation ( $P_D$ ) depends on conditions of mounting on board. This specification is based on the Measurement Conditions below.

Measurement Conditions

	Standard Land Pattern
Environment	Mounting on Board (Wind Velocity=0m/s)
Board Material	Glass Cloth Epoxy Plastic (Double-layers)
Board Dimensions	40mm × 40mm × 1.6mm
Copper Ratio	Topside: Approx. 50%, Backside: Approx. 50%
Through-hole	φ0.5mm × 44pcs

Measurement Result

( $T_a=25^{\circ}\text{C}$ ,  $T_{jmax}=125^{\circ}\text{C}$ )

	Standard Land Pattern	Free Air
Power Dissipation	380mW	150mW
Thermal Resistance	$\theta_{ja} = (125-25^{\circ}\text{C})/0.38\text{W} = 263^{\circ}\text{C/W}$	667 $^{\circ}\text{C/W}$

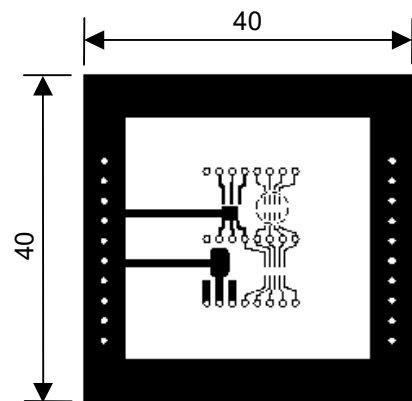
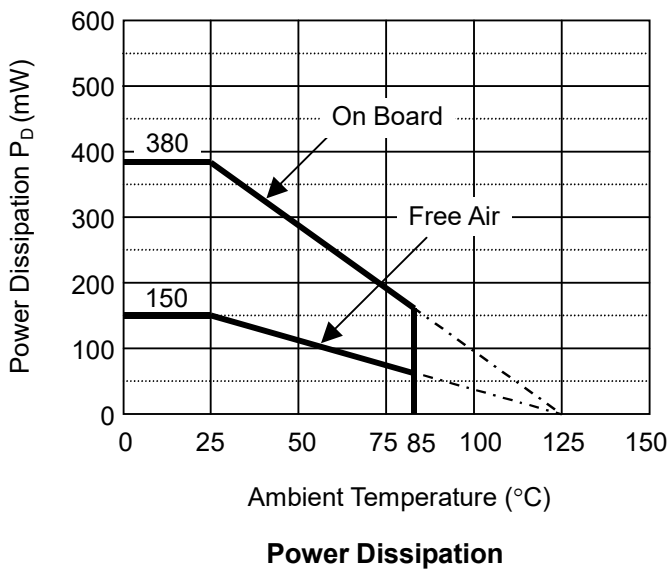

Measurement Board Pattern

○ IC Mount Area (Unit : mm)

PACKAGE DIMENSIONS (SC-82AB)

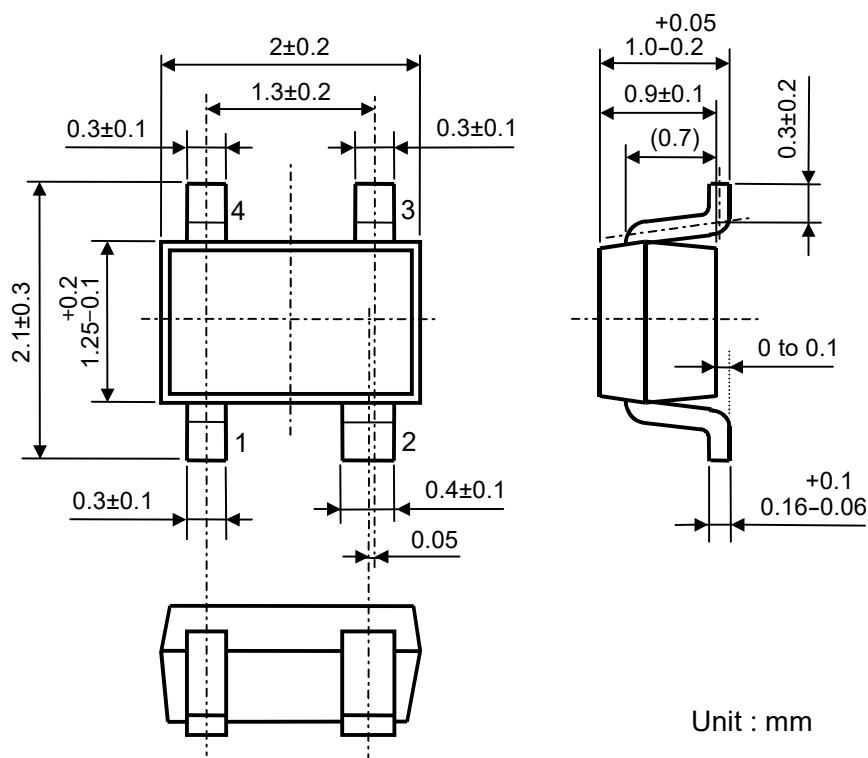

MARK SPECIFICATION (SC-82AB)

- ①②: Product Code ... **Refer to R1180Q Series Mark Specification Table**
- ③④: Lot Number ... Alphanumeric Serial Number

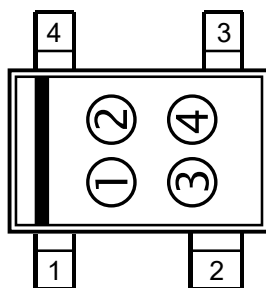

## R1180Q MARK SPECIFICATION TABLE (SC-82AB)

## R1180Qxx1B Series

Product Name	①②
R1180Q121B	A2
R1180Q131B	A3
R1180Q141B	A4
R1180Q151B	A5
R1180Q161B	A6
R1180Q171B	A7
R1180Q181B	A8
R1180Q191B	A9
R1180Q201B	B0
R1180Q211B	B1
R1180Q221B	B2
R1180Q231B	B3
R1180Q241B	B4
R1180Q251B	B5
R1180Q261B	B6
R1180Q271B	B7
R1180Q281B	B8
R1180Q291B	B9
R1180Q301B	C0
R1180Q311B	C1
R1180Q321B	C2
R1180Q331B	C3
R1180Q341B	C4
R1180Q351B	C5
R1180Q361B	C6
R1180Q181B5	C7
R1180Q261B5	C8

## R1180Qxx1C Series

Product Name	①②
R1180Q121C	D2
R1180Q131C	D3
R1180Q141C	D4
R1180Q151C	D5
R1180Q161C	D6
R1180Q171C	D7
R1180Q181C	D8
R1180Q191C	D9
R1180Q201C	E0
R1180Q211C	E1
R1180Q221C	E2
R1180Q231C	E3
R1180Q241C	E4
R1180Q251C	E5
R1180Q261C	E6
R1180Q271C	E7
R1180Q281C	E8
R1180Q291C	E9
R1180Q301C	F0
R1180Q311C	F1
R1180Q321C	F2
R1180Q331C	F3
R1180Q341C	F4
R1180Q351C	F5
R1180Q361C	F6
R1180Q181C5	F7
R1180Q261C5	F8

**POWER DISSIPATION (SOT-23-5)**

Power Dissipation ( $P_D$ ) depends on conditions of mounting on board. This specification is based on the measurement at the condition below:

(Power Dissipation (SOT-23-5) is substitution of SOT-23-6.)

**\* Measurement Conditions**

	Standard Test Land Pattern
Environment	Mounting on Board (Wind velocity=0m/s)
Board Material	Glass cloth epoxy plastic (Double sided)
Board Dimensions	40mm*40mm*1.6mm
Copper Ratio	Top side: Approx. 50%, Back side: Approx. 50%
Through-holes	$\phi$ 0.5mm * 44pcs

**\* Measurement Result:**

( $T_a=25^\circ\text{C}$ ,  $T_{j\text{max}}=125^\circ\text{C}$ )

	Standard Land Pattern	Free Air
Power Dissipation	420mW	250mW
Thermal Resistance	$\theta_{ja} = (125-25^\circ\text{C})/0.42\text{W} = 238^\circ\text{C/W}$	$400^\circ\text{C/W}$

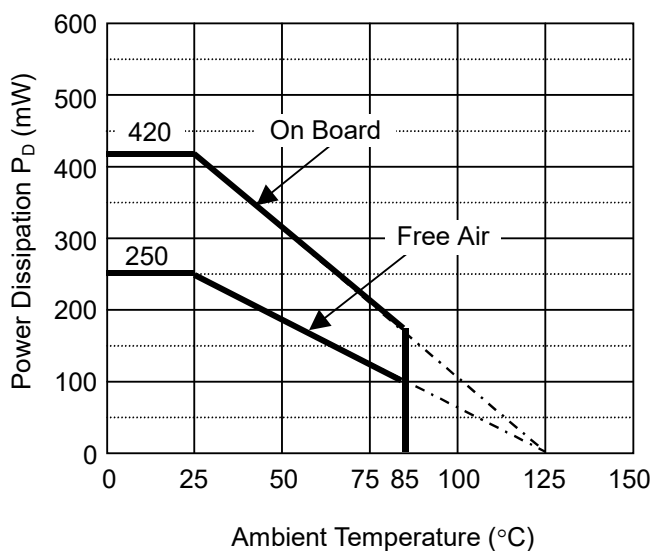
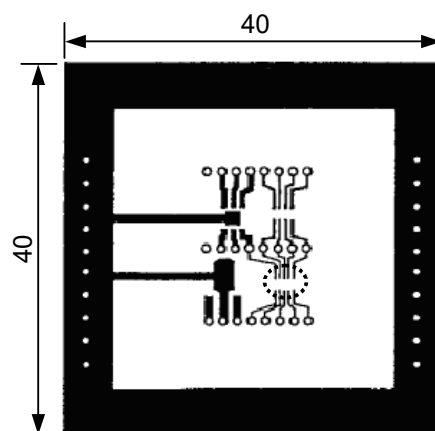
**Power Dissipation****Measurement Board Pattern**

 IC Mount Area (Unit: mm)

**PACKAGE DIMENSIONS (SOT-23-5)**

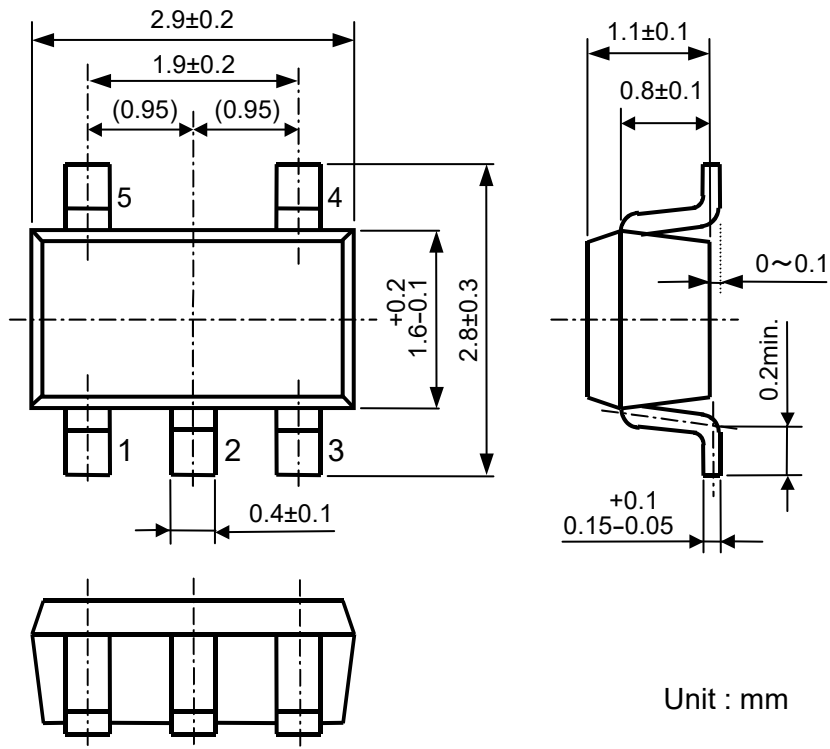

**MARK SPECIFICATION (SOT-23-5)**

- ①②③ : Product Code ... **Refer to R1180N Series Mark Specification Table**
- ④⑤ : Lot Number ... Alphanumeric Serial Number

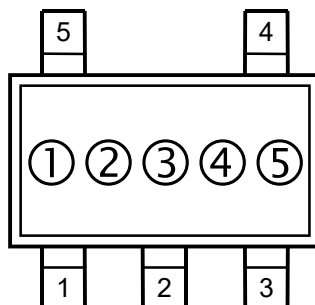

## R1180N MARK SPECIFICATION TABLE (SOT-23-5)

R1180Nxx1B Series		R1180Nxx1C Series	
Product Name	①②③	Product Name	①②③
R1180N121B	C12	R1180N121C	D12
R1180N131B	C13	R1180N131C	D13
R1180N141B	C14	R1180N141C	D14
R1180N151B	C15	R1180N151C	D15
R1180N161B	C16	R1180N161C	D16
R1180N171B	C17	R1180N171C	D17
R1180N181B	C18	R1180N181C	D18
R1180N191B	C19	R1180N191C	D19
R1180N201B	C20	R1180N201C	D20
R1180N211B	C21	R1180N211C	D21
R1180N221B	C22	R1180N221C	D22
R1180N231B	C23	R1180N231C	D23
R1180N241B	C24	R1180N241C	D24
R1180N251B	C25	R1180N251C	D25
R1180N261B	C26	R1180N261C	D26
R1180N271B	C27	R1180N271C	D27
R1180N281B	C28	R1180N281C	D28
R1180N291B	C29	R1180N291C	D29
R1180N301B	C30	R1180N301C	D30
R1180N311B	C31	R1180N311C	D31
R1180N321B	C32	R1180N321C	D32
R1180N331B	C33	R1180N331C	D33
R1180N341B	C34	R1180N341C	D34
R1180N351B	C35	R1180N351C	D35
R1180N361B	C36	R1180N361C	D36
R1180N181B5	C37	R1180N181C5	D37
R1180N261B5	C38	R1180N261C5	D38

**TEST CIRCUITS**

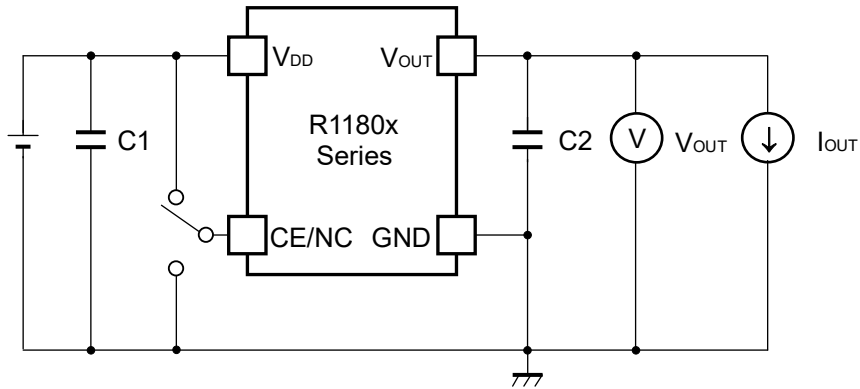

C1=Ceramic 1.0 $\mu$ F  
C2=Ceramic 0.1 $\mu$ F

**Standard test Circuit**

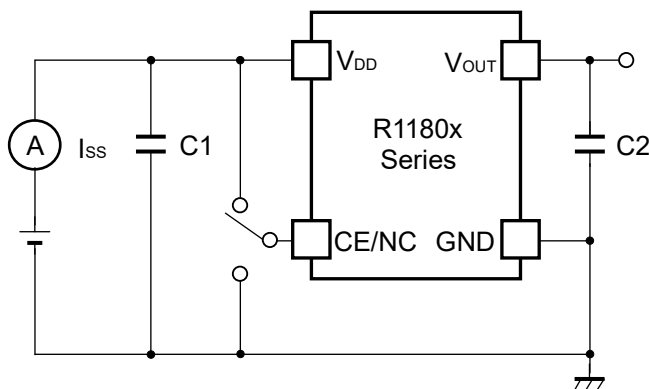

C1=Ceramic 1.0 $\mu$ F  
C2=Ceramic 0.1 $\mu$ F

**Supply Current Test Circuit**

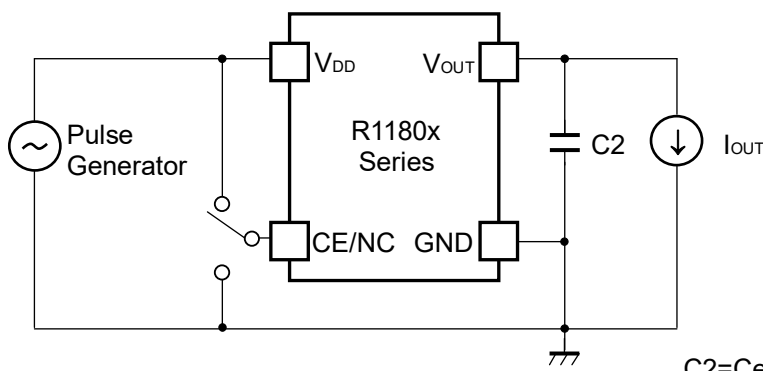

C2=Ceramic 0.1 $\mu$ F

**Ripple Rejection, Line Transient Response Test Circuit**



## TYPICAL CHARACTERISTICS

### 1) Output Voltage vs. Output Current (T<sub>opt</sub>=25°C)

R1180x121x

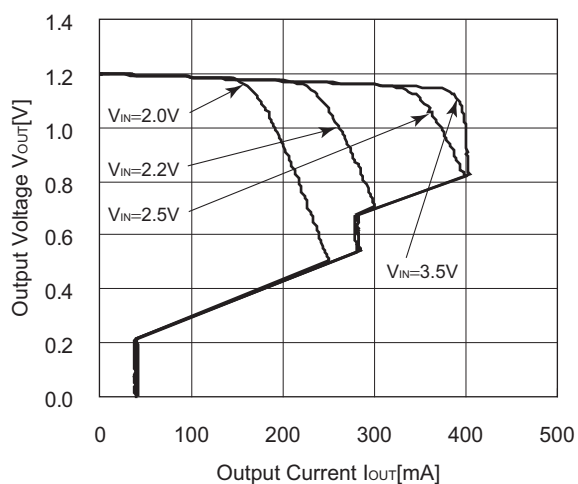

R1180x281x

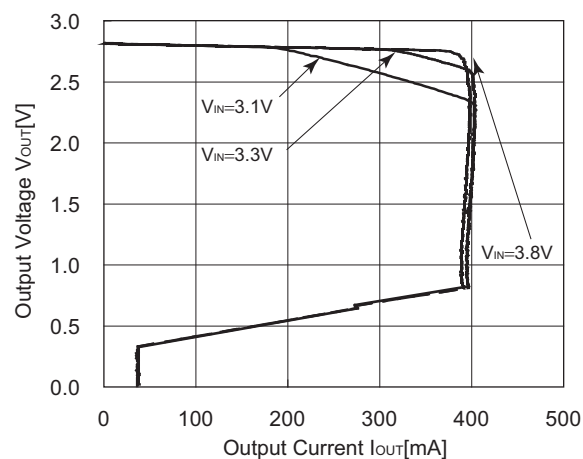

R1180x361x

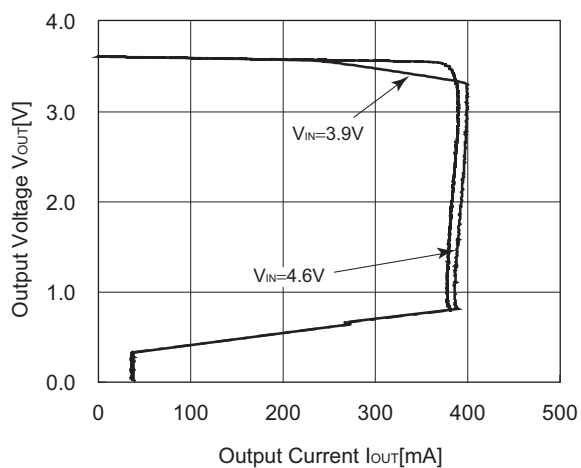

### 2) Output Voltage vs. Input Voltage (T<sub>opt</sub>=25°C)

R1180x121x

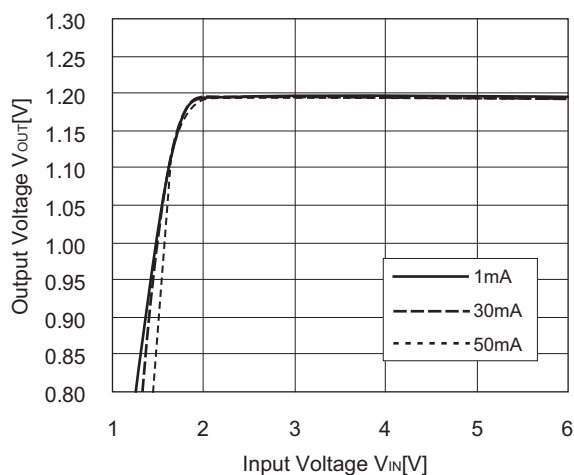

R1180x281x

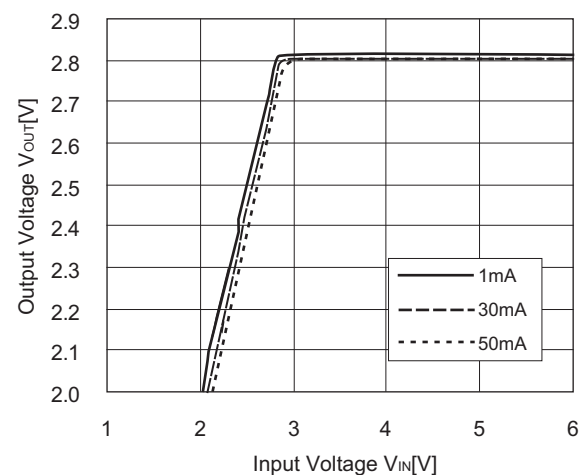

**R1180x361x**

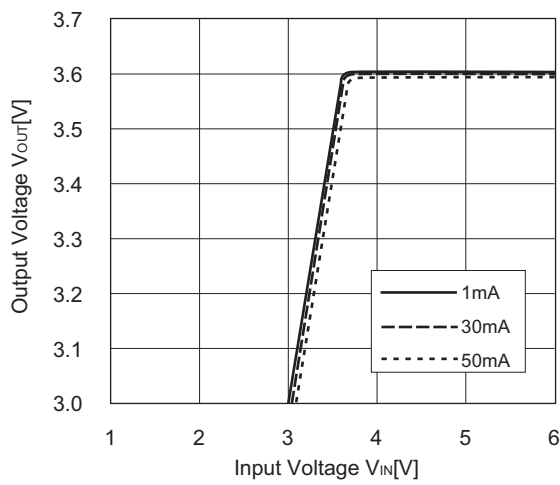

3) Dropout Voltage vs. Output Current

**R1180x121x**

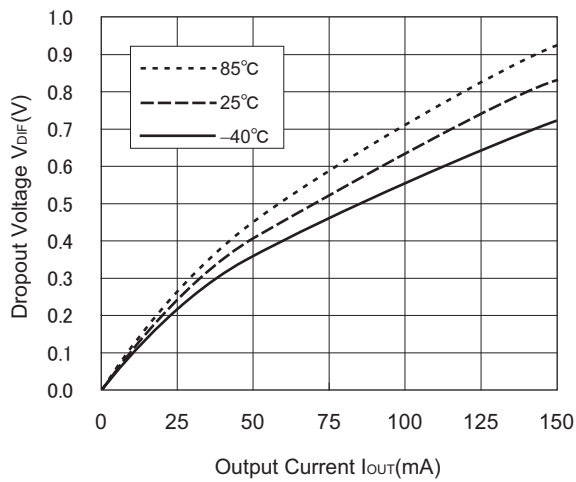

**R1180x281x**

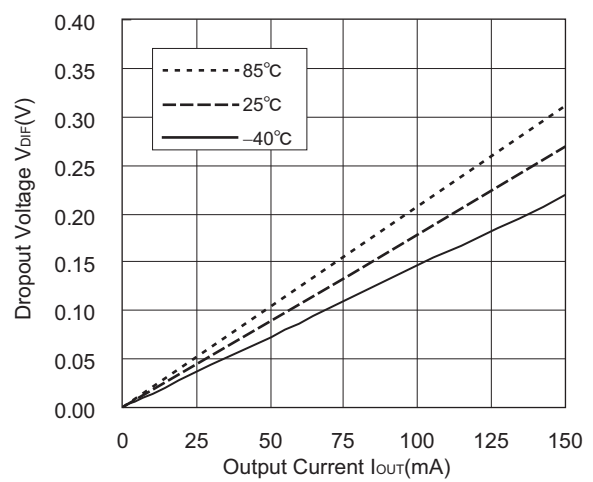

**R1180x361x**

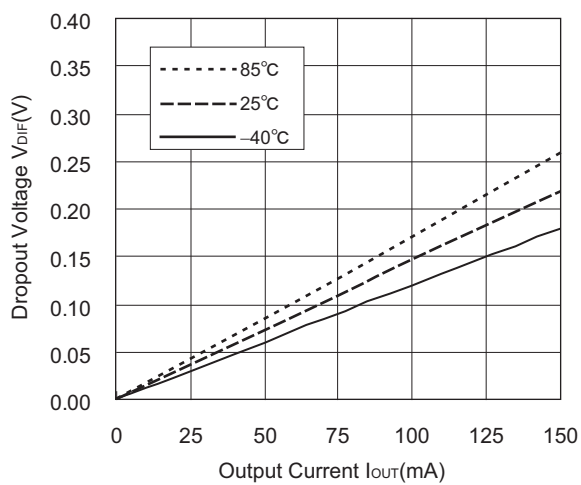

4) Output Voltage vs. Temperature ( $I_{OUT}=30mA$ )

**R1180x121x ( $V_{IN}=2.2V$ )**

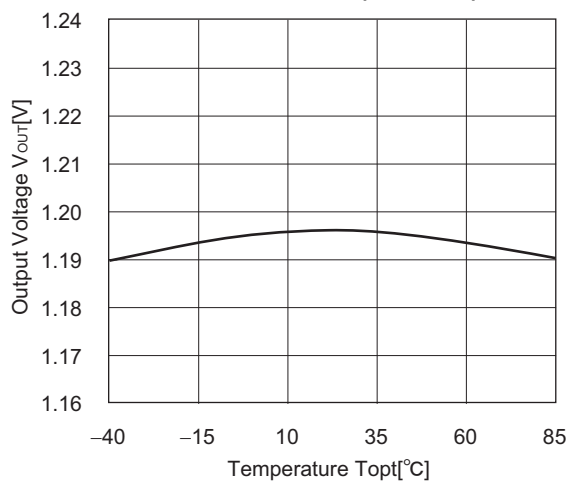

**R1180x281x ( $V_{IN}=3.8V$ )**

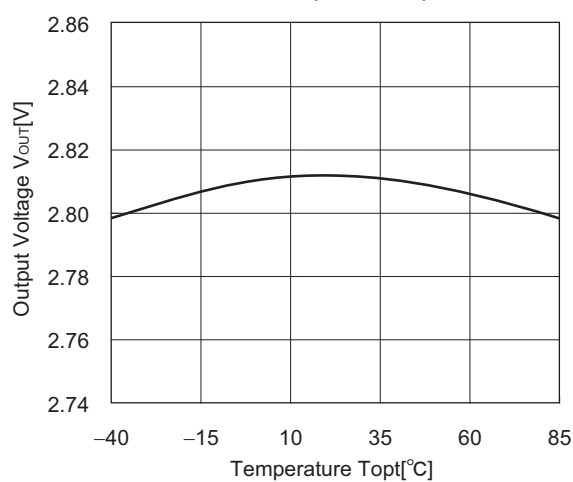

**R1180x361x ( $V_{IN}=4.6V$ )**

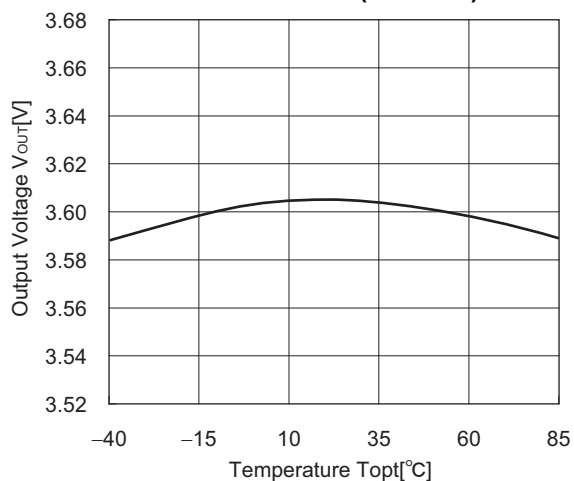

5) Supply Current vs. Input Voltage ( $T_{opt}=25^{\circ}C$ )

**R1180x121x**

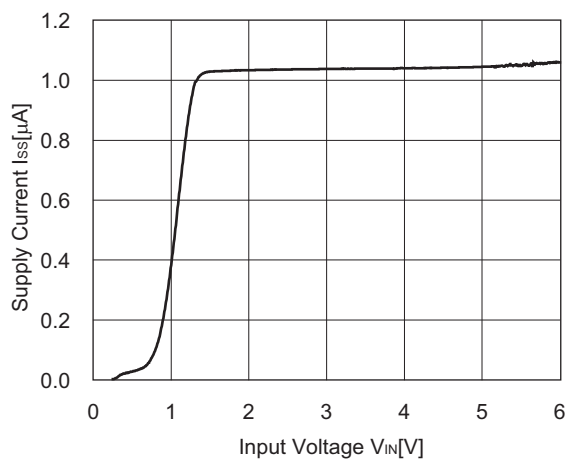

**R1180x281x**

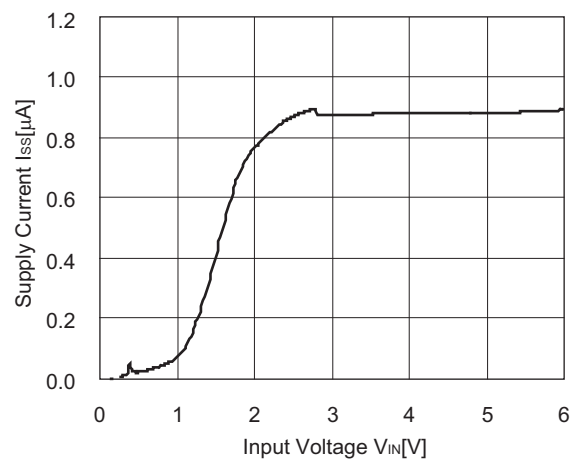

**R1180x361x**

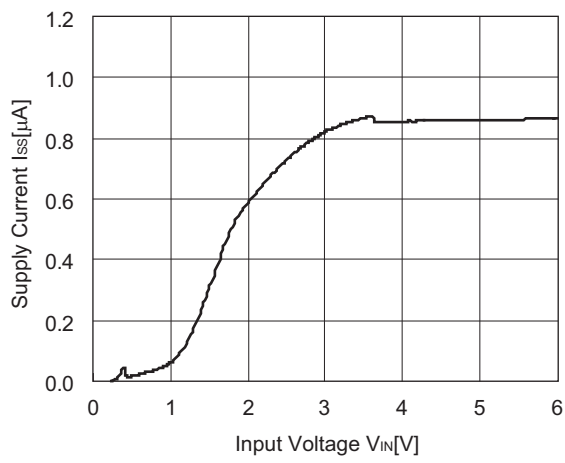

6) Supply Current vs. Temperature

**R1180x121x ( $V_{IN}=2.2V$ )**

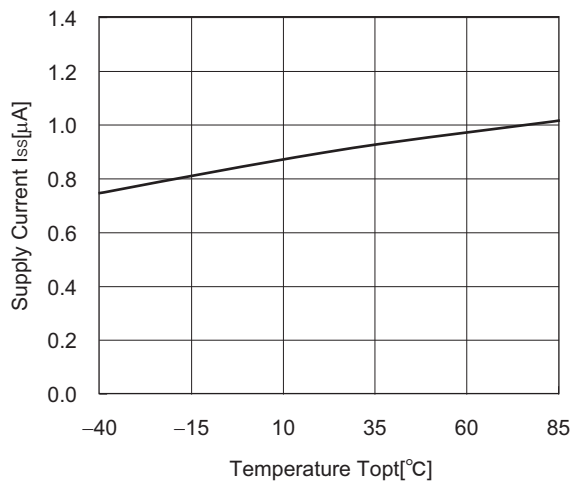

**R1180x281x ( $V_{IN}=3.8V$ )**

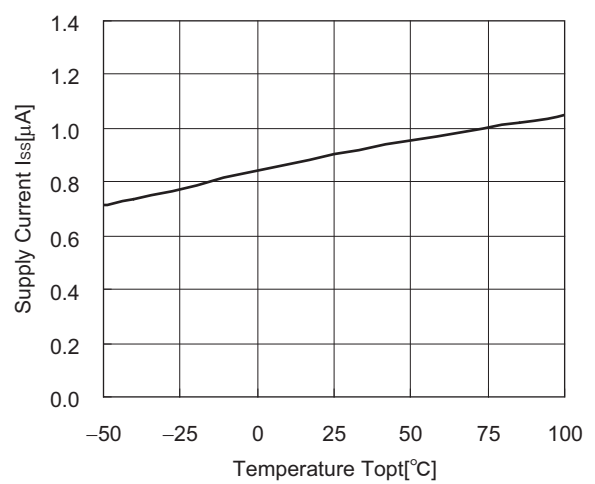

**R1180x361x ( $V_{IN}=4.6V$ )**

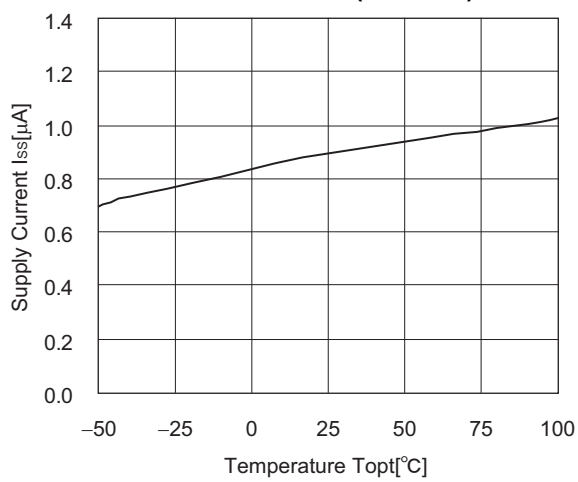

7) Dropout Voltage vs. Set Output Voltage ( $T_{opt}=25^{\circ}C$ )

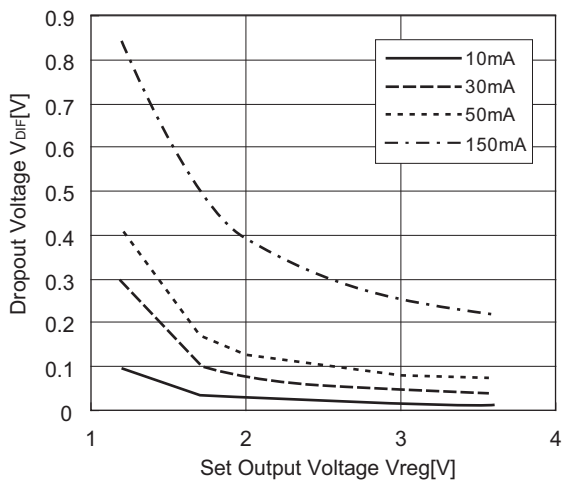

8) Ripple Rejection vs. Frequency ( $C_{IN}=none$ )

R1180x121x

$V_{IN}=2.4V_{DC}+0.5p-p$   
 $C_{OUT}=Ceramic0.1\mu F$

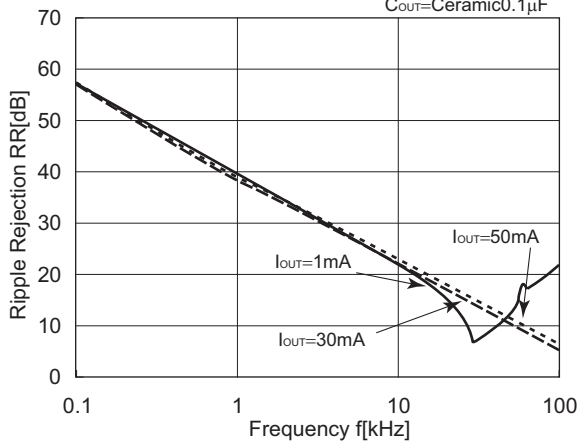

R1180x121x

$V_{IN}=2.4V_{DC}+0.5p-p$   
 $C_{OUT}=Ceramic1\mu F$

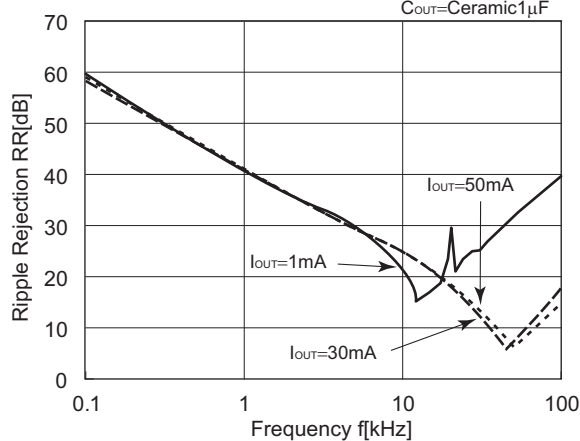

R1180x281x

$V_{IN}=3.8V_{DC}+0.5p-p$   
 $C_{OUT}=Ceramic0.1\mu F$

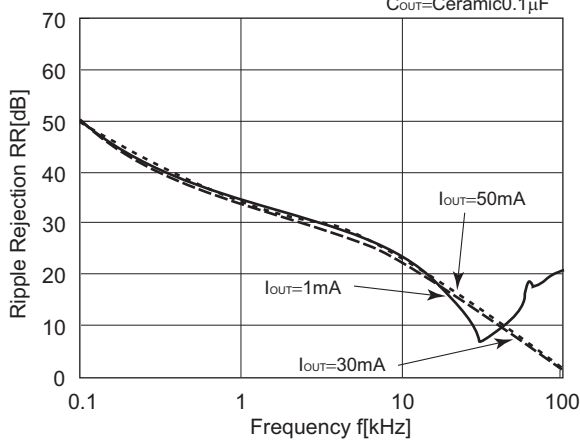

R1180x281x

$V_{IN}=3.8V_{DC}+0.5p-p$   
 $C_{OUT}=Ceramic1\mu F$

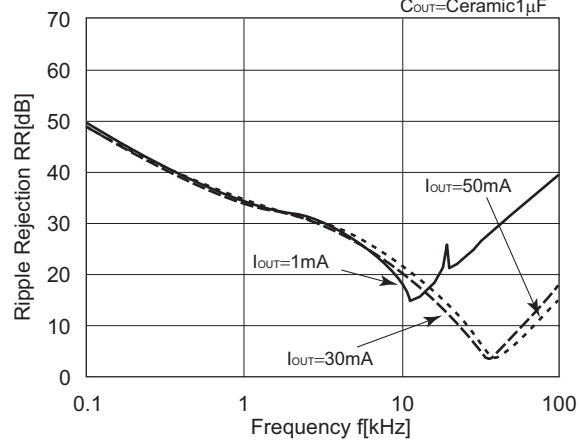

**R1180x361x**

$V_{IN}=4.6V_{DC}+0.5p-p$   
 $C_{OUT}=\text{Ceramic}0.1\mu F$

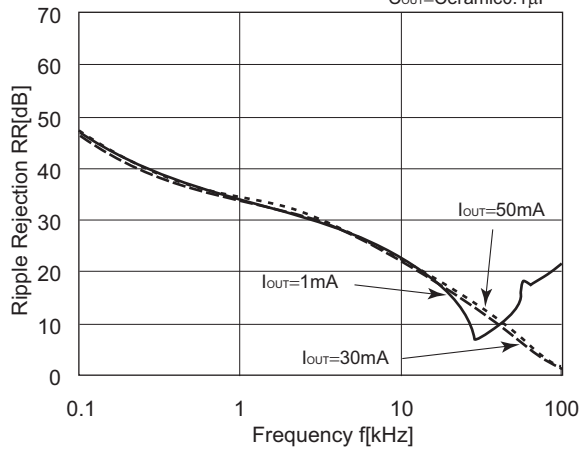

**R1180x361x**

$V_{IN}=4.6V_{DC}+0.5p-p$   
 $C_{OUT}=\text{Ceramic}1\mu F$

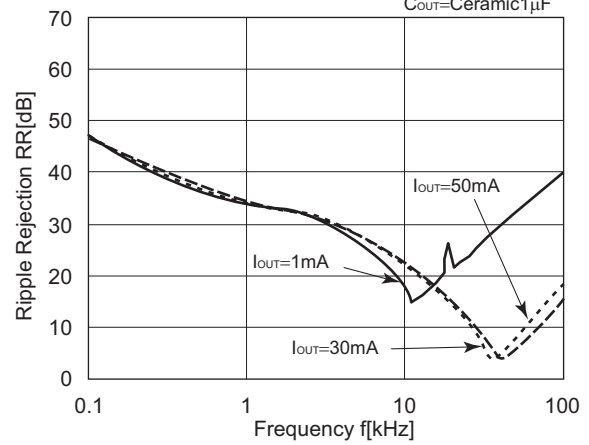

9) Ripple Rejection vs. Input Bias Voltage ( $T_{opt}=25^{\circ}C$ ,  $C_{IN}=\text{none}$ ,  $C_{OUT}=\text{Ceramic}0.1\mu F$ )

**R1180x281x( $I_{OUT}=1mA$ )**

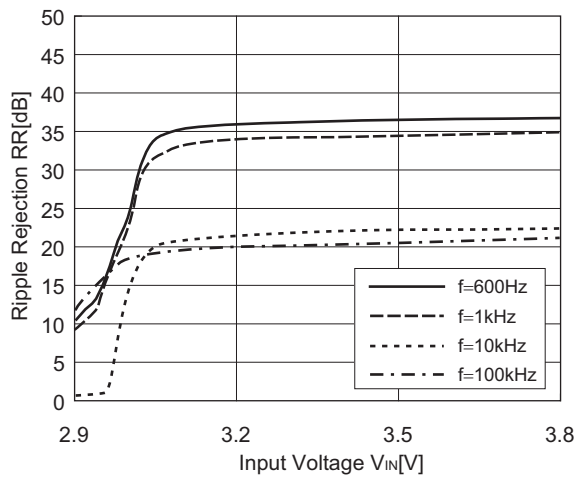

**R1180x281x( $I_{OUT}=30mA$ )**

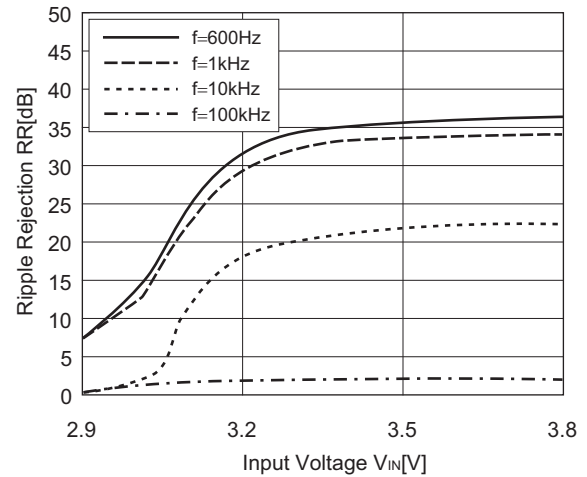

**R1180x281x( $I_{OUT}=50mA$ )**

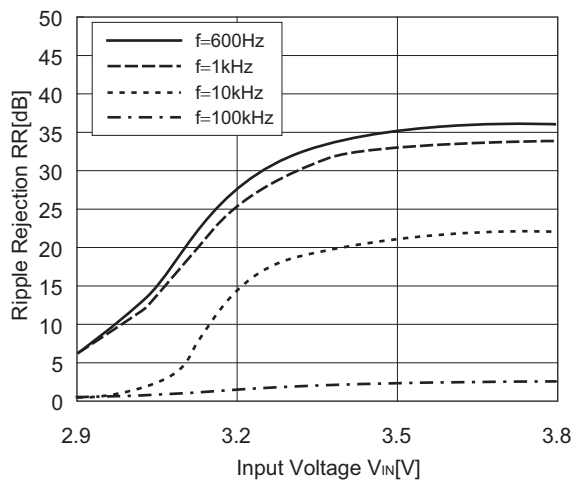

10) Input Transient Response ( $C_{IN}=none, tr=tf=5\mu s$ )

R1180x281x

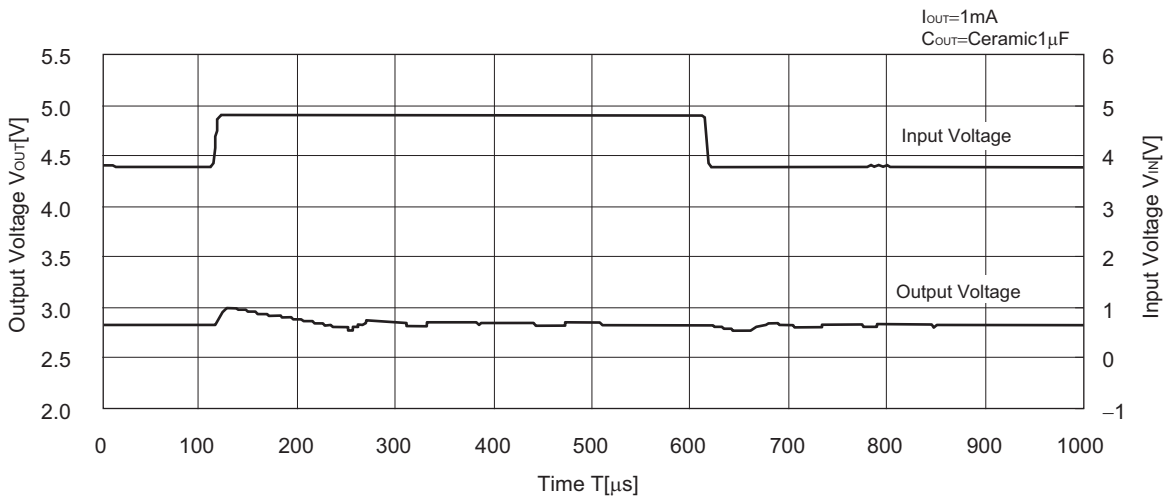

R1180x281x

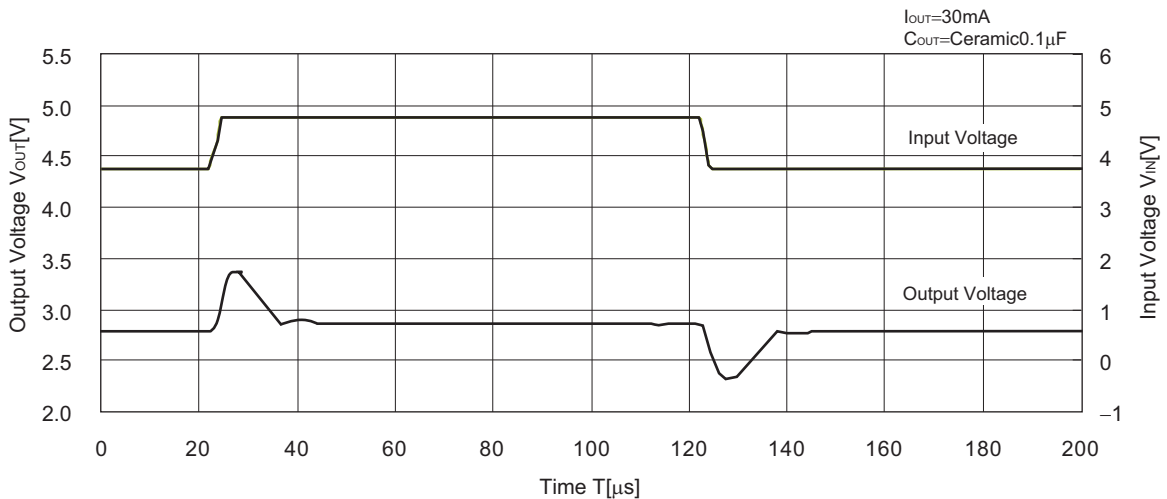

R1180x281x

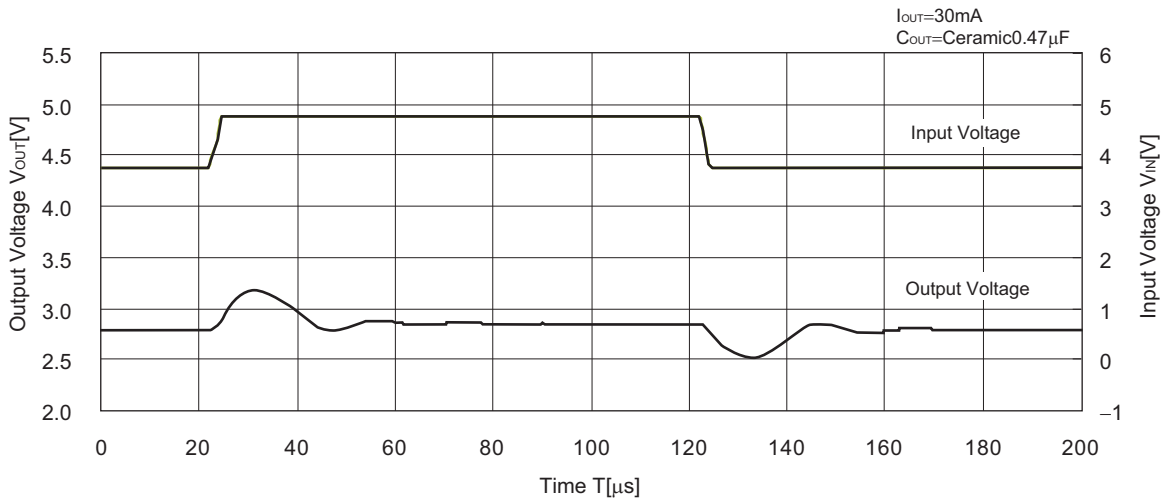

R1180x281x

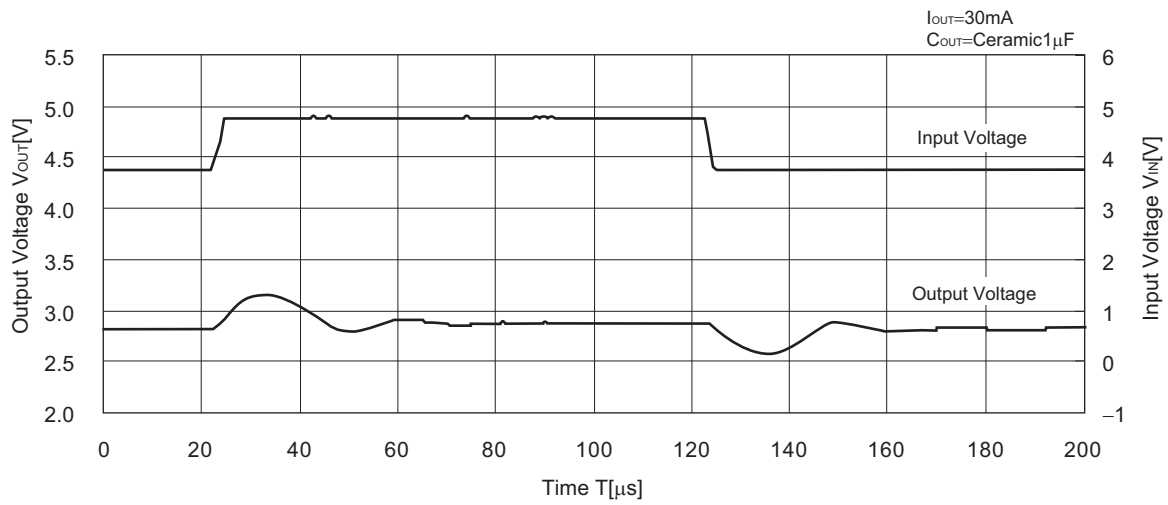

11) Load Transient Response ( $t_r=t_f=0.5\mu s$   $V_{IN}=3.8V$ )

R1180x281x

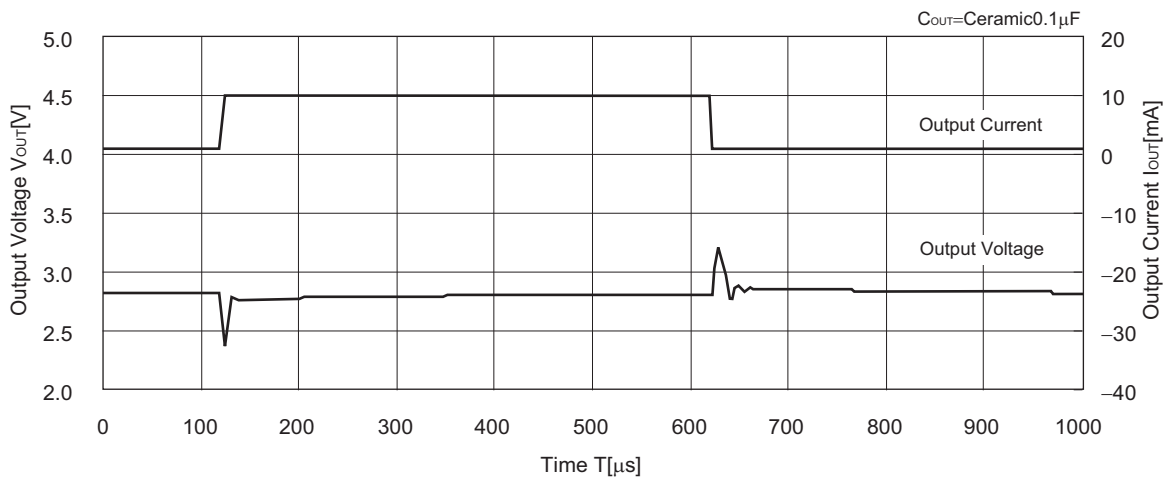

R1180x281x

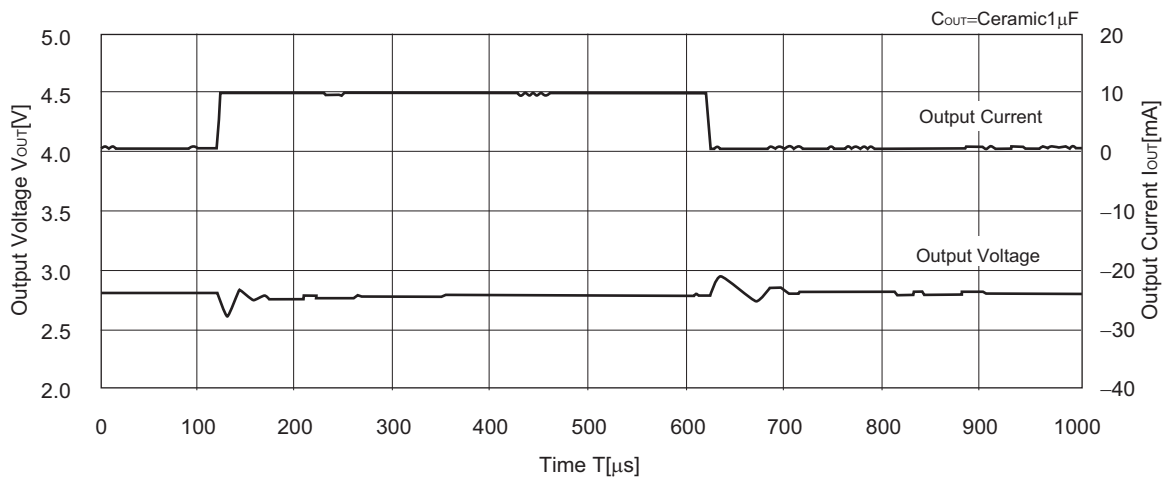



R1180x281x

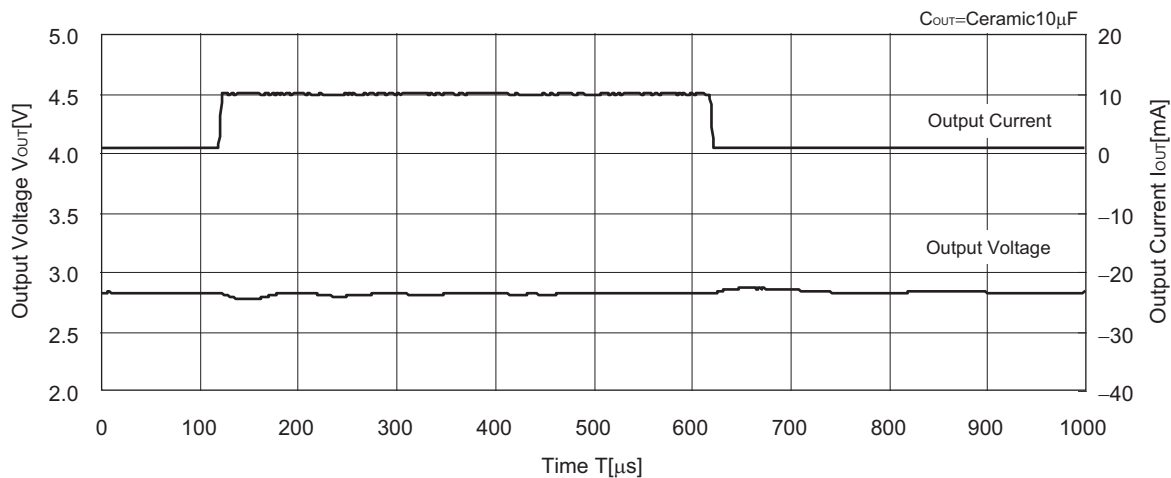

R1180x281x

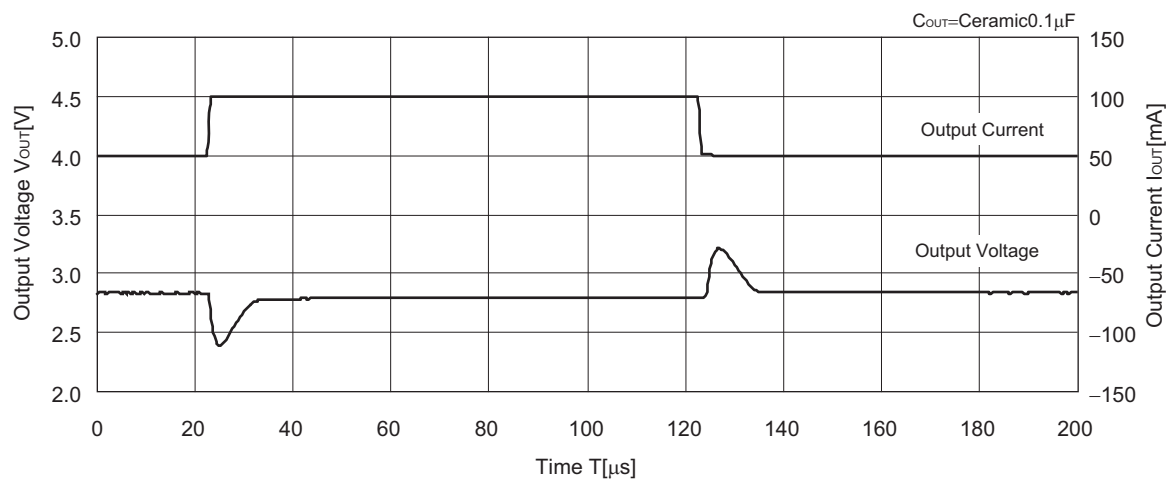

R1180x281x

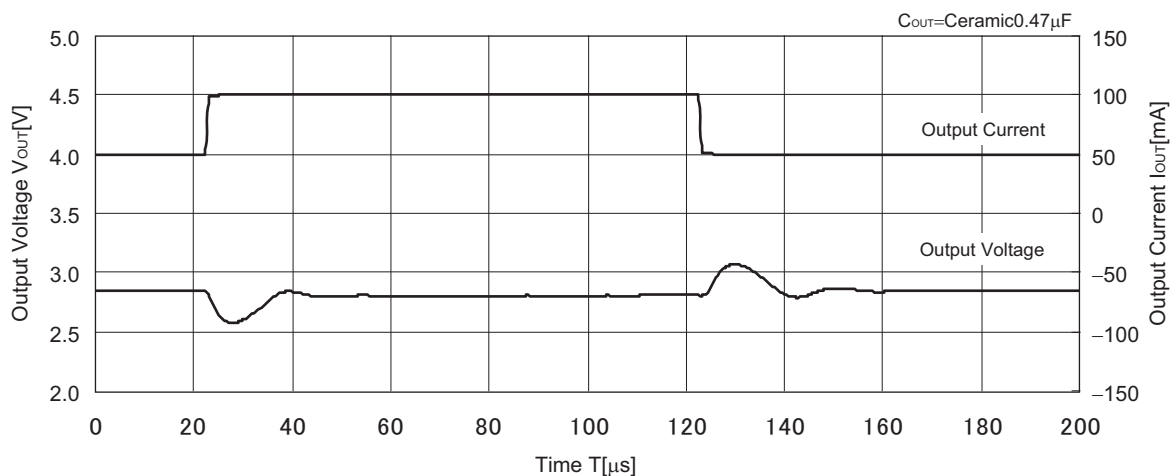

R1180x281x

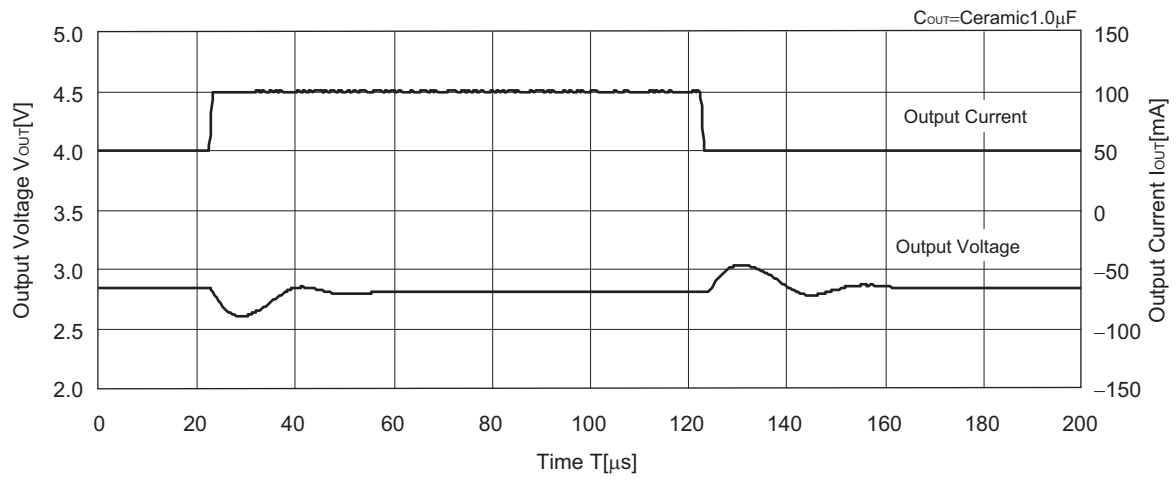

## ESR vs. Output Current

The relations between  $I_{OUT}$  (Output Current) and ESR of an output capacitor are shown above. The conditions when the white noise level is under  $40\mu V$  (Avg.) are marked as the hatched area in the graph.

<Measurement conditions>

- (1)  $V_{IN}=V_{OUT}+1V$
- (2) Frequency Band: 10Hz to 2MHz (BW=30Hz)
- (3) Temperature:  $-40^{\circ}C$  to  $85^{\circ}C$

**R1180x121x**

$C_{IN}$  =Ceramic  $1.0\mu A$ ,  $C_{OUT}$  =Ceramic  $0.1\mu F$

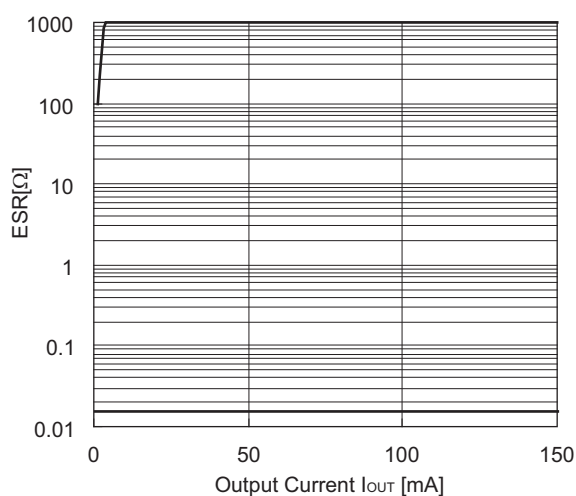

**R1180x281x**

$C_{IN}$  =Ceramic  $1.0\mu A$ ,  $C_{OUT}$  =Ceramic  $0.1\mu F$

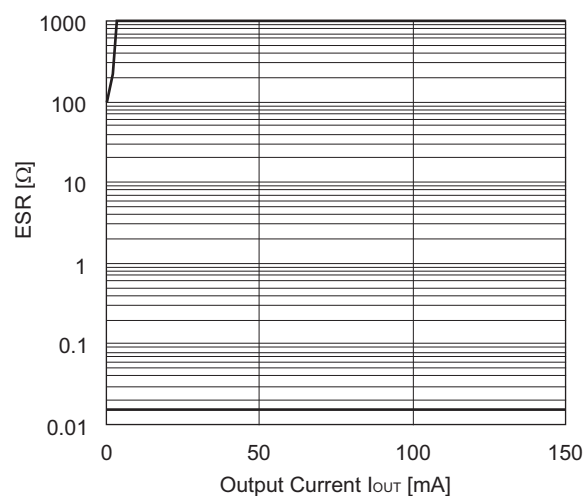

1. The products and the product specifications described in this document are subject to change or discontinuation of production without notice for reasons such as improvement. Therefore, before deciding to use the products, please refer to our sales representatives for the latest information thereon.
2. The materials in this document may not be copied or otherwise reproduced in whole or in part without the prior written consent of us.
3. This product and any technical information relating thereto are subject to complementary export controls (so-called KNOW controls) under the Foreign Exchange and Foreign Trade Law, and related politics ministerial ordinance of the law. (Note that the complementary export controls are inapplicable to any application-specific products, except rockets and pilotless aircraft, that are insusceptible to design or program changes.) Accordingly, when exporting or carrying abroad this product, follow the Foreign Exchange and Foreign Trade Control Law and its related regulations with respect to the complementary export controls.
4. The technical information described in this document shows typical characteristics and example application circuits for the products. The release of such information is not to be construed as a warranty of or a grant of license under our or any third party's intellectual property rights or any other rights.
5. The products listed in this document are intended and designed for use as general electronic components in standard applications (office equipment, telecommunication equipment, measuring instruments, consumer electronic products, amusement equipment etc.). Those customers intending to use a product in an application requiring extreme quality and reliability, for example, in a highly specific application where the failure or misoperation of the product could result in human injury or death should first contact us.
  - Aerospace Equipment
  - Equipment Used in the Deep Sea
  - Power Generator Control Equipment (nuclear, steam, hydraulic, etc.)
  - Life Maintenance Medical Equipment
  - Fire Alarms / Intruder Detectors
  - Vehicle Control Equipment (automotive, airplane, railroad, ship, etc.)
  - Various Safety Devices
  - Traffic control system
  - Combustion equipment

In case your company desires to use this product for any applications other than general electronic equipment mentioned above, make sure to contact our company in advance. Note that the important requirements mentioned in this section are not applicable to cases where operation requirements such as application conditions are confirmed by our company in writing after consultation with your company.

6. We are making our continuous effort to improve the quality and reliability of our products, but semiconductor products are likely to fail with certain probability. In order to prevent any injury to persons or damages to property resulting from such failure, customers should be careful enough to incorporate safety measures in their design, such as redundancy feature, fire containment feature and fail-safe feature. We do not assume any liability or responsibility for any loss or damage arising from misuse or inappropriate use of the products.
7. The products have been designed and tested to function within controlled environmental conditions. Do not use products under conditions that deviate from methods or applications specified in this datasheet. Failure to employ the products in the proper applications can lead to deterioration, destruction or failure of the products. We shall not be responsible for any bodily injury, fires or accident, property damage or any consequential damages resulting from misuse or misapplication of the products.
8. **Quality Warranty**
  - 8-1. **Quality Warranty Period**

In the case of a product purchased through an authorized distributor or directly from us, the warranty period for this product shall be one (1) year after delivery to your company. For defective products that occurred during this period, we will take the quality warranty measures described in section 8-2. However, if there is an agreement on the warranty period in the basic transaction agreement, quality assurance agreement, delivery specifications, etc., it shall be followed.
  - 8-2. **Quality Warranty Remedies**

When it has been proved defective due to manufacturing factors as a result of defect analysis by us, we will either deliver a substitute for the defective product or refund the purchase price of the defective product.

Note that such delivery or refund is sole and exclusive remedies to your company for the defective product.
  - 8-3. **Remedies after Quality Warranty Period**

With respect to any defect of this product found after the quality warranty period, the defect will be analyzed by us. On the basis of the defect analysis results, the scope and amounts of damage shall be determined by mutual agreement of both parties. Then we will deal with upper limit in Section 8-2. This provision is not intended to limit any legal rights of your company.
9. Anti-radiation design is not implemented in the products described in this document.
10. The X-ray exposure can influence functions and characteristics of the products. Confirm the product functions and characteristics in the evaluation stage.
11. WLCSP products should be used in light shielded environments. The light exposure can influence functions and characteristics of the products under operation or storage.
12. Warning for handling Gallium and Arsenic (GaAs) products (Applying to GaAs MMIC, Photo Reflector). These products use Gallium (Ga) and Arsenic (As) which are specified as poisonous chemicals by law. For the prevention of a hazard, do not burn, destroy, or process chemically to make them as gas or power. When the product is disposed of, please follow the related regulation and do not mix this with general industrial waste or household waste.
13. Please contact our sales representatives should you have any questions or comments concerning the products or the technical information.



**Nisshinbo Micro Devices Inc.**

**Official website**

<https://www.nisshinbo-microdevices.co.jp/en/>

**Purchase information**

<https://www.nisshinbo-microdevices.co.jp/en/buy/>