

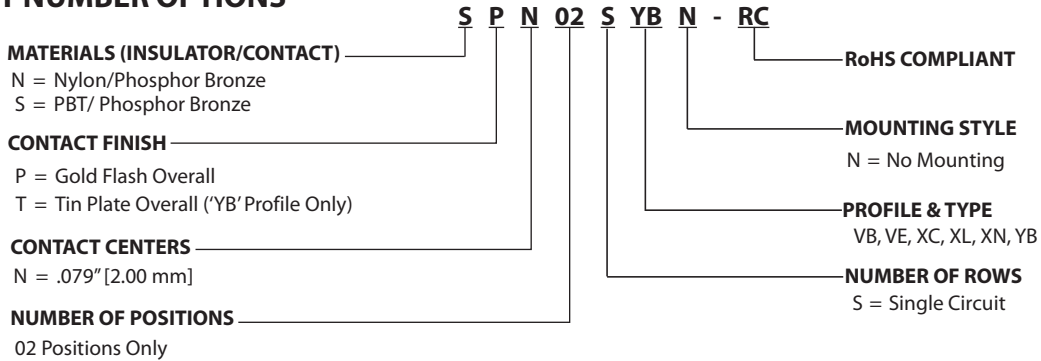

### SPECIFICATIONS

- Insulator Material: Nylon/PBT
- Contact Material: Phosphor Bronze
- Plating: Gold Flash Overall
- 1, 2 or 3 Amps current rating
- UL Flammability Rating: 94V-0/94V-2
- Dual Beam Contacts

### PART NUMBER OPTIONS



### DIMENSIONS Dimensions in [ ] are in millimeters, all others are in inches.

#### OPEN TOP - SINGLE CIRCUIT

##### STANDARD

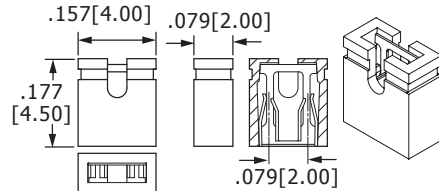
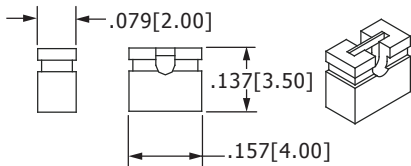

##### SPN02SYBN-RC STN02SYBN-RC

##### SPN02SXCN-RC

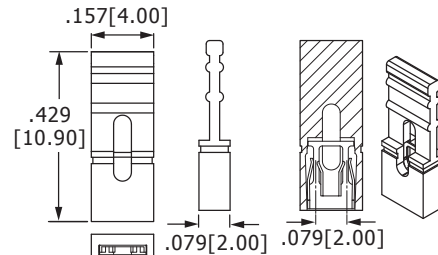
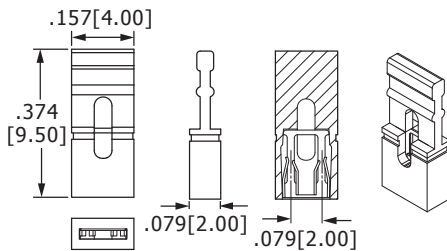

##### NPN02SXLN-RC

##### NPN02SXNN-RC

#### CLOSED TOP - SINGLE CIRCUIT

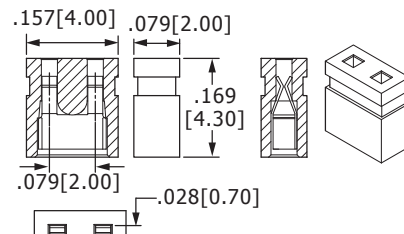
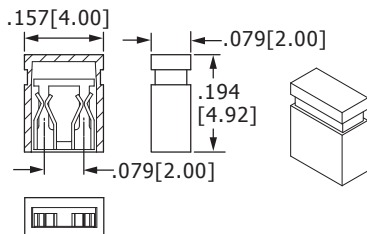

##### SPN02SVEN-RC

##### SPN02SVBN-RC