

# Emitter common (dual transistors)

## UMW1N / FMW1

●Features

- 1) Two 2SC2412K chips in a UMT or SMT package.
- 2) Mounting cost and area can be cut in half.

●Structure

Epitaxial planar type  
NPN silicon transistor

The following characteristics apply to both Tr<sub>1</sub> and Tr<sub>2</sub>.

●External dimensions (Units: mm)

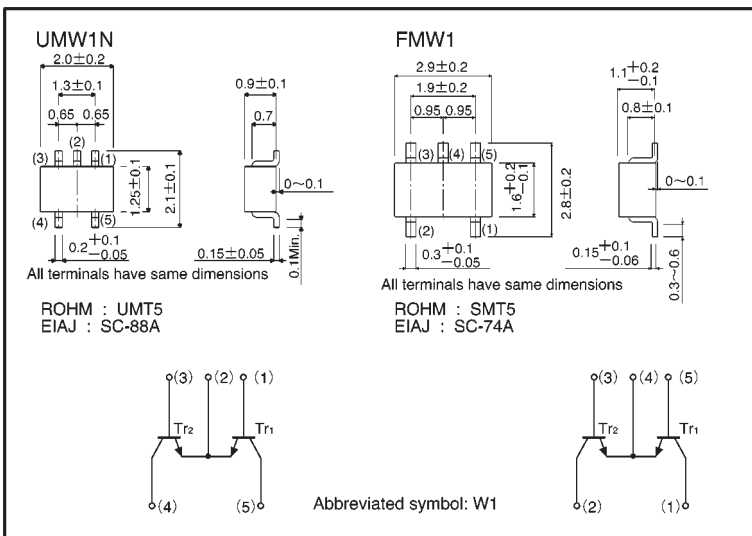

●Absolute maximum ratings (Ta = 25°C)

Parameter	Symbol	Limits	Unit
Collector-base voltage	V <sub>CB0</sub>	60	V
Collector-emitter voltage	V <sub>CE0</sub>	50	V
Emitter-base voltage	V <sub>EB0</sub>	7	V
Collector current	I <sub>c</sub>	150	mA
Power dissipation	UMW1N	150 (TOTAL)	mW *1
	FMW1	300 (TOTAL)	
Junction temperature	T <sub>j</sub>	150	°C
Storage temperature	T <sub>stg</sub>	-55~+150	°C

\*1 120mW per element must not be exceeded.

\*2 200mW per element must not be exceeded.

●Electrical characteristics (Ta = 25°C)

Parameter	Symbol	Min.	Typ.	Max.	Unit	Conditions
Collector-base breakdown voltage	$BV_{CBO}$	60	—	—	V	$I_C=50\mu A$
Collector-emitter breakdown voltage	$BV_{CEO}$	50	—	—	V	$I_C=1mA$
Emitter-base breakdown voltage	$BV_{EBO}$	7	—	—	V	$I_E=50\mu A$
Collector cutoff current	$I_{CBO}$	—	—	0.1	$\mu A$	$V_{CB}=60V$
Emitter cutoff current	$I_{EBO}$	—	—	0.1	$\mu A$	$V_{EB}=7V$
Collector-emitter saturation voltage	$V_{CE(sat)}$	—	—	0.4	V	$I_C/I_B=50mA/5mA$
DC current transfer ratio	$h_{FE}$	120	—	560	—	$V_{CE}=6V, I_C=1mA$
Transition frequency	$f_r$	—	180	—	MHz	$V_{CE}=12V, I_E=2mA, f=100MHz$
Output capacitance	$C_{ob}$	—	2	3.5	pF	$V_{CB}=12V, I_E=0A, f=1MHz$

●Packaging specifications

Part No.	Packaging type	Taping	
	Code	TR	T148
	Basic ordering unit (pieces)	3000	3000
UMW1N		○	—
FMW1		—	○

●Electrical characteristic curves

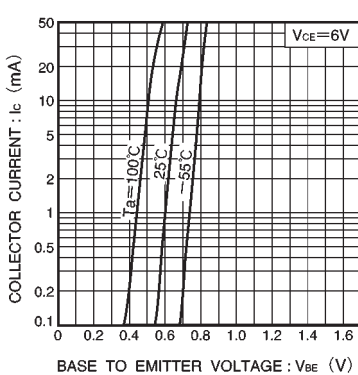

Fig.1 Grounded emitter propagation characteristics

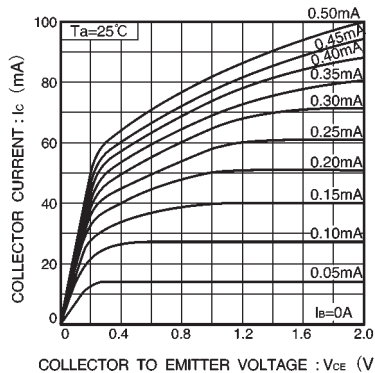

Fig.2 Grounded emitter output characteristics ( I )

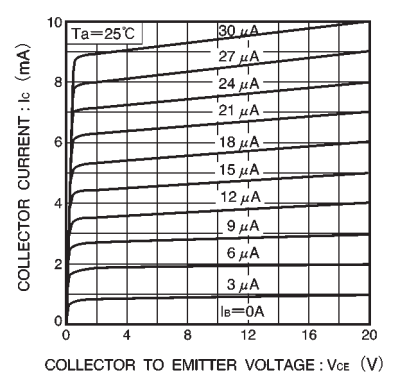

Fig.3 Grounded emitter output characteristics ( II )

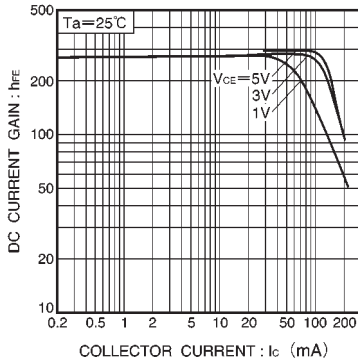

Fig.4 DC current gain vs. collector current ( I )

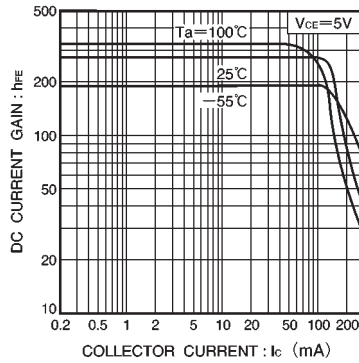

Fig.5 DC current gain vs. collector current ( II )

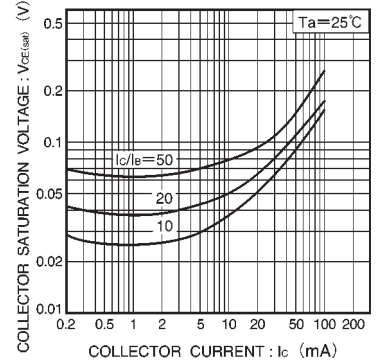

Fig.6 Collector-emitter saturation voltage vs. collector current

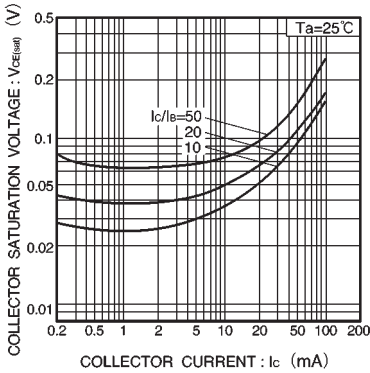

Fig.7 Collector-emitter saturation voltage vs. collector current ( I )

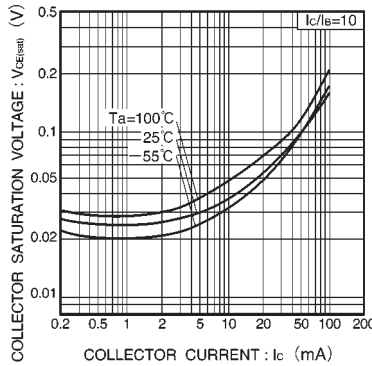

Fig.8 Collector-emitter saturation voltage vs. collector current ( II )

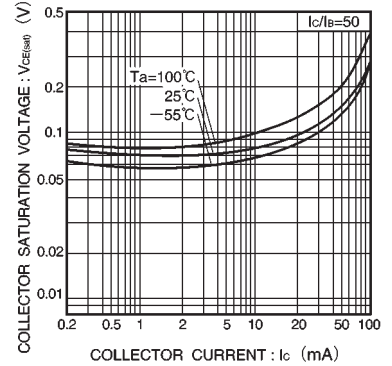

Fig.9 Collector-emitter saturation voltage vs. collector current ( III )

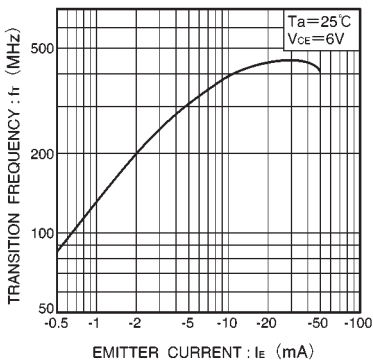

Fig.10 Gain bandwidth product vs. emitter current

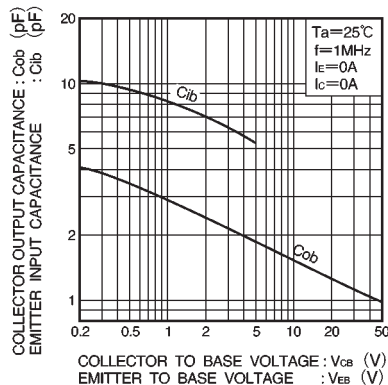

Fig.11 Collector output capacitance vs. collector-base voltage  
Emitter input capacitance vs. emitter-base voltage

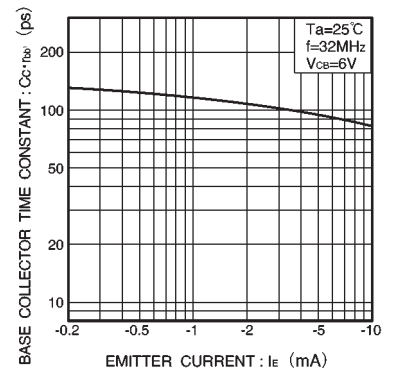

Fig.12 Base-collector time constant vs. emitter current