

Evaluation Board for Dual High Speed Operational Amplifiers (16-Lead, 4 mm × 4 mm LFCSP with Dedicated Feedback Pin)

FEATURES

- Enables quick breadboarding/prototyping**
- User-defined circuit configuration**
- Edge-mounted SMA connector provisions**
- Easy connection to test equipment and other circuits**
- Two independent circuits enhance flexibility**

GENERAL DESCRIPTION

The EB-O16CP44-2Z is designed to aid in the evaluation of dual high speed operational amplifiers. The EB-O16CP44-2Z is a bare board (that is, there are no components soldered to the board) that enables users to quickly prototype a variety of operational amplifier circuits, which minimizes risk and reduces time to market. The EB-O16CP44-2Z evaluation board supports any of the Analog Devices, Inc., dual high speed operational amplifiers in 16-lead, 4 mm × 4 mm lead frame chip scale packages (LFCSP) with dedicated feedback pins.

Figure 1 and Figure 2 show the component side and the circuit side of the evaluation board, respectively. Figure 3 shows the evaluation board schematic.

The 4-layer evaluation board accepts edge-mounted SMA connectors on both inputs and outputs, which allows efficient and quick connection to test equipment or other circuitry.

The board ground plane, component placement, and power supply bypassing are optimized for maximum circuit flexibility and performance. The evaluation board uses a variety of SMT component case sizes: 0402, 0508, 0603, and 7343.

Figure 4 and Figure 6 show the evaluation board assembly drawings. The metal layout pattern for connecting the board to the op amp and to the supporting circuitry is shown in Figure 5 and Figure 7.

EVALUATION BOARD COMPONENT AND CIRCUIT SIDE DIAGRAMS

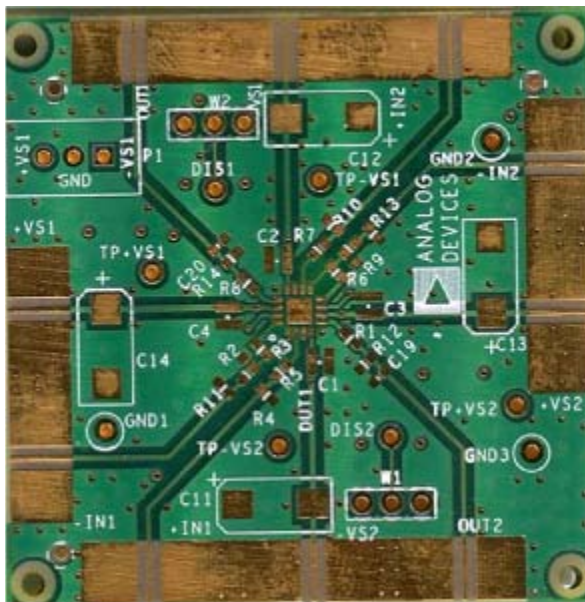

NOTES

1. THE EVALUATION BOARD SILKSCREEN PART NUMBER LABELING ON YOUR BOARD MAY BE DIFFERENT FROM WHAT IS SHOWN HERE.

Figure 1. EB-O16CP44-2Z Component Side of PCB

081776-001

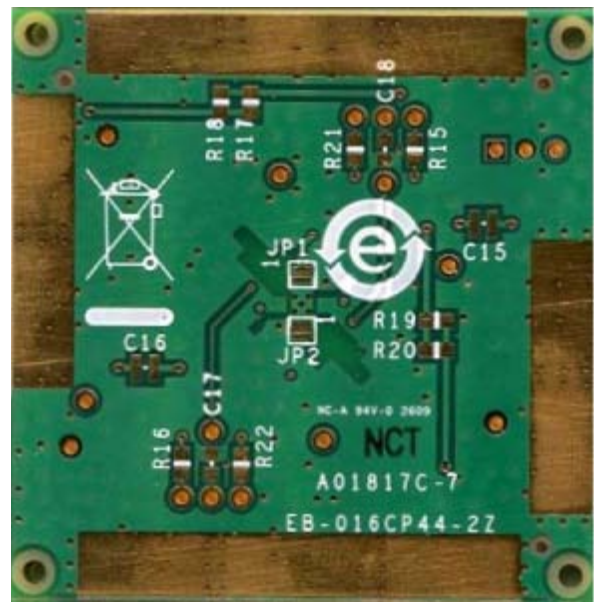

NOTES

1. THE EVALUATION BOARD SILKSCREEN PART NUMBER LABELING ON YOUR BOARD MAY BE DIFFERENT FROM WHAT IS SHOWN HERE.

Figure 2. EB-O16CP44-2Z Circuit Side of PCB

081776-007

TABLE OF CONTENTS

Features	1	Evaluation Board Schematic	3
General Description	1	Assembly Drawing and Board Layout	4
Evaluation Board Component and Circuit Side Diagrams.....	1	Ordering Information.....	5
Revision History	2	Bill of Materials.....	5

REVISION HISTORY

5/10—Rev. 0 to Rev. A

Changes to Figure 1.....	1
Added Figure 2; Renumbered Sequentially	1
Added Table 1.....	5

1/10—Revision 0: Initial Version

EVALUATION BOARD SCHEMATIC

08776-002

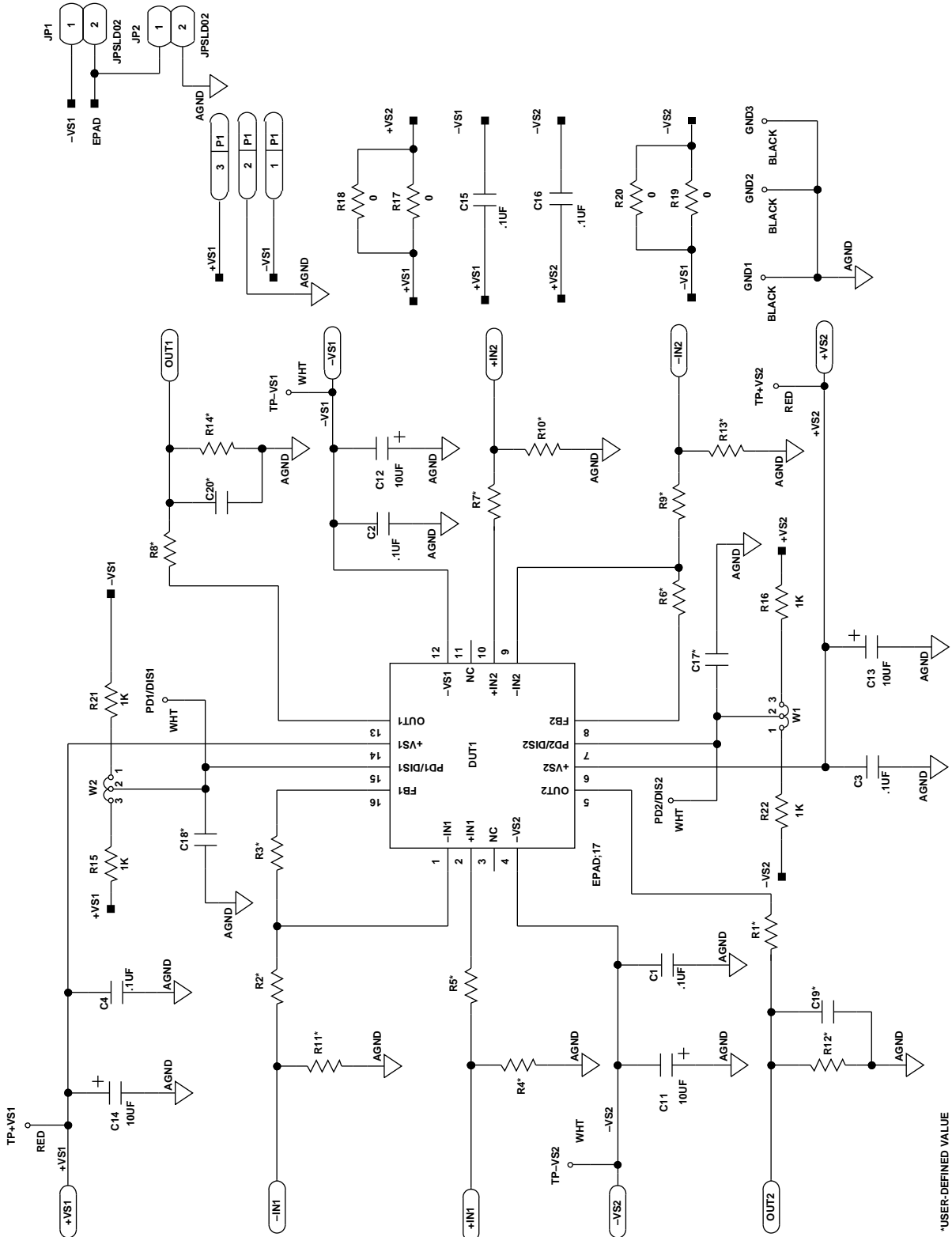

Figure 3. Universal Evaluation Board Schematic

*USER-DEFINED VALUE

ASSEMBLY DRAWING AND BOARD LAYOUT

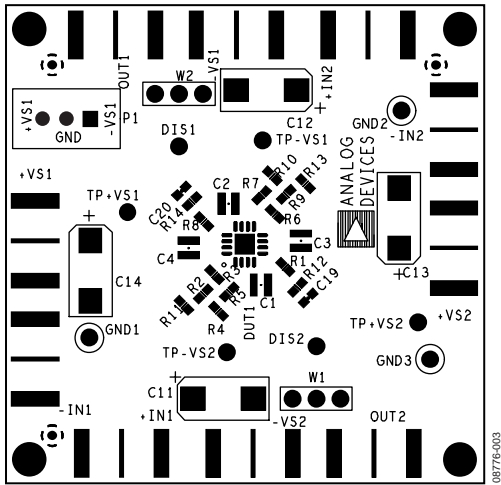

Figure 4. Board Assembly Drawing, Component Side

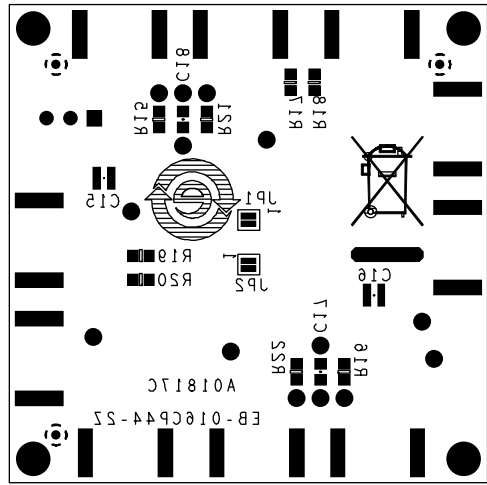

Figure 6. Board Assembly Drawing, Circuit Side

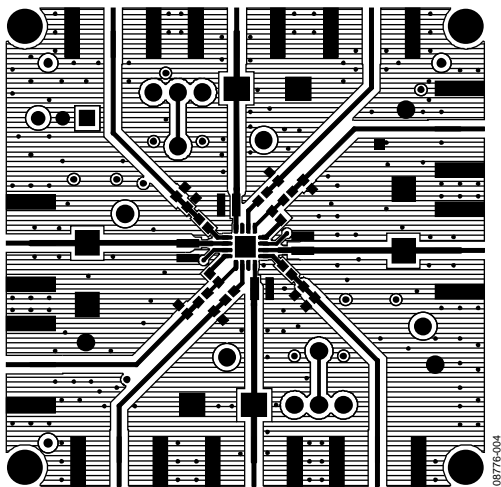

Figure 5. Board Layout Pattern, Component Side

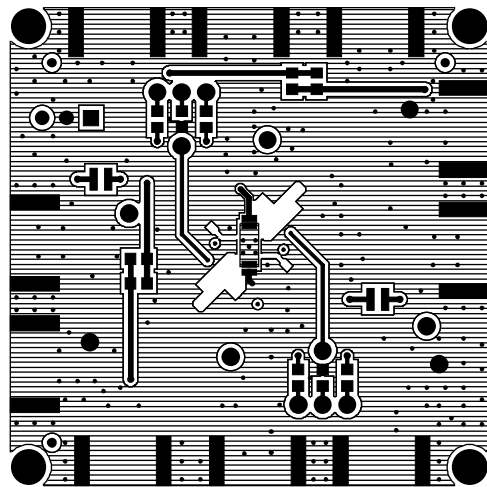

Figure 7. Board Layout Pattern, Circuit Side

ORDERING INFORMATION**BILL OF MATERIALS**

Table 1.

Quantity	Reference Designator	Description	Package
6	+IN1, +IN2, -IN1, -IN2, OUT1, OUT2	SMA/SMT	SMA/SMT
6	C1, C2, C3, C4, C15, C16	0.1 μ F capacitor	C0508
2	C17, C18	User-defined capacitor	C0603
2	C19, C20	User-defined capacitor	C0402
4	C11, C12, C13, C14	10 μ F capacitor	C6032
14	R1, R2, R3, R4, R5, R6, R7, R8, R9, R10, R11, R12, R13, R14	User-defined resistor	R0402
4	R17, R18, R19, R20	0 Ω , short the two supplies together	R0603
4	R15, R16, R21, R22	1 k Ω	R0603
9	PD1/DIS1, PD2/DIS2, GND1 to GND3, +VS1, -VS1, +VS2, -VS2	Test point	TP
1	P1	Header 3-position	Molex 22-23-2031
2	W1, W2	3-pin straight header	Molex 22-03-2031
2	JP1, JP2	User-defined jumper	Solder jumper
1	U1	Amplifier	SOIC

NOTES

NOTES

NOTES

**ESD Caution**

ESD (electrostatic discharge) sensitive device. Charged devices and circuit boards can discharge without detection. Although this product features patented or proprietary protection circuitry, damage may occur on devices subjected to high energy ESD. Therefore, proper ESD precautions should be taken to avoid performance degradation or loss of functionality.

Legal Terms and Conditions

By using the evaluation board discussed herein (together with any tools, components documentation or support materials, the "Evaluation Board"), you are agreeing to be bound by the terms and conditions set forth below ("Agreement") unless you have purchased the Evaluation Board, in which case the Analog Devices Standard Terms and Conditions of Sale shall govern. Do not use the Evaluation Board until you have read and agreed to the Agreement. Your use of the Evaluation Board shall signify your acceptance of the Agreement. This Agreement is made by and between you ("Customer") and Analog Devices, Inc. ("ADI"), with its principal place of business at One Technology Way, Norwood, MA 02062, USA. Subject to the terms and conditions of the Agreement, ADI hereby grants to Customer a free, limited, personal, temporary, non-exclusive, non-sublicensable, non-transferable license to use the Evaluation Board FOR EVALUATION PURPOSES ONLY. Customer understands and agrees that the Evaluation Board is provided for the sole and exclusive purpose referenced above, and agrees not to use the Evaluation Board for any other purpose. Furthermore, the license granted is expressly made subject to the following additional limitations: Customer shall not (i) rent, lease, display, sell, transfer, assign, sublicense, or distribute the Evaluation Board; and (ii) permit any Third Party to access the Evaluation Board. As used herein, the term "Third Party" includes any entity other than ADI, Customer, their employees, affiliates and in-house consultants. The Evaluation Board is NOT sold to Customer; all rights not expressly granted herein, including ownership of the Evaluation Board, are reserved by ADI. CONFIDENTIALITY. This Agreement and the Evaluation Board shall all be considered the confidential and proprietary information of ADI. Customer may not disclose or transfer any portion of the Evaluation Board to any other party for any reason. Upon discontinuation of use of the Evaluation Board or termination of this Agreement, Customer agrees to promptly return the Evaluation Board to ADI. ADDITIONAL RESTRICTIONS. Customer may not disassemble, decompile or reverse engineer chips on the Evaluation Board. Customer shall inform ADI of any occurred damages or any modifications or alterations it makes to the Evaluation Board, including but not limited to soldering or any other activity that affects the material content of the Evaluation Board. Modifications to the Evaluation Board must comply with applicable law, including but not limited to the RoHS Directive. TERMINATION. ADI may terminate this Agreement at any time upon giving written notice to Customer. Customer agrees to return to ADI the Evaluation Board at that time. LIMITATION OF LIABILITY. THE EVALUATION BOARD PROVIDED HEREUNDER IS PROVIDED "AS IS" AND ADI MAKES NO WARRANTIES OR REPRESENTATIONS OF ANY KIND WITH RESPECT TO IT. ADI SPECIFICALLY DISCLAIMS ANY REPRESENTATIONS, ENDORSEMENTS, GUARANTEES, OR WARRANTIES, EXPRESS OR IMPLIED, RELATED TO THE EVALUATION BOARD INCLUDING, BUT NOT LIMITED TO, THE IMPLIED WARRANTY OF MERCHANTABILITY, TITLE, FITNESS FOR A PARTICULAR PURPOSE OR NONINFRINGEMENT OF INTELLECTUAL PROPERTY RIGHTS. IN NO EVENT WILL ADI AND ITS LICENSORS BE LIABLE FOR ANY INCIDENTAL, SPECIAL, INDIRECT, OR CONSEQUENTIAL DAMAGES RESULTING FROM CUSTOMER'S POSSESSION OR USE OF THE EVALUATION BOARD, INCLUDING BUT NOT LIMITED TO LOST PROFITS, DELAY COSTS, LABOR COSTS OR LOSS OF GOODWILL. ADI'S TOTAL LIABILITY FROM ANY AND ALL CAUSES SHALL BE LIMITED TO THE AMOUNT OF ONE HUNDRED US DOLLARS (\$100.00). EXPORT. Customer agrees that it will not directly or indirectly export the Evaluation Board to another country, and that it will comply with all applicable United States federal laws and regulations relating to exports. GOVERNING LAW. This Agreement shall be governed by and construed in accordance with the substantive laws of the Commonwealth of Massachusetts (excluding conflict of law rules). Any legal action regarding this Agreement will be heard in the state or federal courts having jurisdiction in Suffolk County, Massachusetts, and Customer hereby submits to the personal jurisdiction and venue of such courts. The United Nations Convention on Contracts for the International Sale of Goods shall not apply to this Agreement and is expressly disclaimed.