

# Schottky Barrier Rectifiers, Surface Mount, 2 A, 20 V - 150 V

## SS22FA - S215FA

### Features

- Low Power Loss, High Efficiency
- Guard Ring for Overvoltage Protection
- High Surge Current Capability
- UL Flammability 94V-0 Classification
- MSL 1 per J-STD-020
- Green Molding Compound
- NRVB Prefix for Automotive and Other Applications Requiring Unique Site and Control Change Requirements; AEC-Q101 Qualified and PPAP Capable
- These Devices are Pb-Free and are RoHS Compliant



**ON Semiconductor®**

[www.onsemi.com](http://www.onsemi.com)

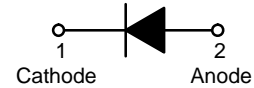

Rectifier



SOD-123FL  
CASE 425AB

### MARKING DIAGRAM

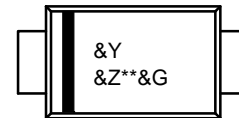

Band Indicates Cathode

- &Y = Binary Calendar Year Coding Scheme
- &Z = Assembly Plant Code
- \*\* = Specific Device Code  
(see "Top Mark" in the table below)
- &G = Single Digit Weekly Date Code

### ORDERING INFORMATION

Part Number	Top Mark	Package	Shipping†
SS22FA	22L	SOD-123FL (Pb-Free)	3000 / Tape & Reel
NRVBSS22FA			
SS23FA	23L	SOD-123FL (Pb-Free)	3000 / Tape & Reel
NRVBSS23FA			
SS25FA	25L	SOD-123FL (Pb-Free)	3000 / Tape & Reel
NRVBSS25FA			
SS29FA	29L	SOD-123FL (Pb-Free)	3000 / Tape & Reel
NRVBSS29FA			
S210FA	20L	SOD-123FL (Pb-Free)	3000 / Tape & Reel
NRVBS210FA			
S215FA	2AL	SOD-123FL (Pb-Free)	3000 / Tape & Reel
NRVBS215FA			

†For information on tape and reel specifications, including part orientation and tape sizes, please refer to our Tape and Reel Packaging Specifications Brochure, BRD8011/D.

# SS22FA – S215FA

## SPECIFICATIONS

### ABSOLUTE MAXIMUM RATINGS (T<sub>A</sub> = 25°C unless otherwise noted)

Symbol	Parameter	Value						Unit
		SS22FA	SS23FA	SS25FA	SS29FA	S210FA	S215FA	
V <sub>RRM</sub>	Repetitive Peak Reverse Voltage	20	30	50	90	100	150	V
V <sub>RMS</sub>	RMS Reverse Voltage	14	21	35	63	70	105	V
V <sub>R</sub>	DC Blocking Voltage	20	30	50	90	100	150	V
I <sub>F(AV)</sub>	Average Forward Rectified Current	2						A
I <sub>FSM</sub>	Peak Forward Surge Current: 8.3 ms Single Half Sine-Wave Superimposed on Rated Load	50						A
T <sub>J</sub>	Operating Junction Temperature Range	-55 to +125		-55 to +150				°C
T <sub>STG</sub>	Storage Temperature Range	-55 to +150						°C

Stresses exceeding those listed in the Maximum Ratings table may damage the device. If any of these limits are exceeded, device functionality should not be assumed, damage may occur and reliability may be affected.

### THERMAL CHARACTERISTICS (T<sub>A</sub> = 25°C unless otherwise noted) (Note 1)

Symbol	Characteristic	Value	Unit
Ψ <sub>JL</sub>	Junction-to-Lead Thermal Characteristics	16	°C/W
R <sub>θJA</sub>	Junction-to-Ambient Thermal Resistance	152	°C/W

1. Per JE51-3 Recommended Thermal Test Board. Device mounted on FR-4 PCB, board size = 76.2 mm x 114.3 mm.

### ELECTRICAL CHARACTERISTICS (T<sub>A</sub> = 25°C unless otherwise noted)

Symbol	Parameter	Conditions	Value						Unit
			SS22FA	SS23FA	SS25FA	SS29FA	S210FA	S215FA	
V <sub>F</sub>	Maximum Instantaneous Forward Voltage (Note 2)	I <sub>F</sub> = 2 A	0.50		0.70	0.85		0.95	V
I <sub>R</sub>	Maximum Reverse Current at Rated V <sub>R</sub>	T <sub>J</sub> = 25°C	0.4			0.1			mA
		T <sub>J</sub> = 100°C	15		10				
		T <sub>J</sub> = 125°C			5				
C <sub>J</sub>	Typical Junction Capacitance	V <sub>R</sub> = 4 V, f = 1 MHz	120		93	62		48	pF
T <sub>rr</sub>	Typical Reverse Recovery Time	I <sub>F</sub> = 0.5 A, I <sub>R</sub> = 1 A, I <sub>RR</sub> = 0.25 A	10		9	7		13	ns

Product parametric performance is indicated in the Electrical Characteristics for the listed test conditions, unless otherwise noted. Product performance may not be indicated by the Electrical Characteristics if operated under different conditions.

2. Pulse test with PW = 300 μs, 1% duty cycle.

# SS22FA – S215FA

## TYPICAL PERFORMANCE CHARACTERISTICS

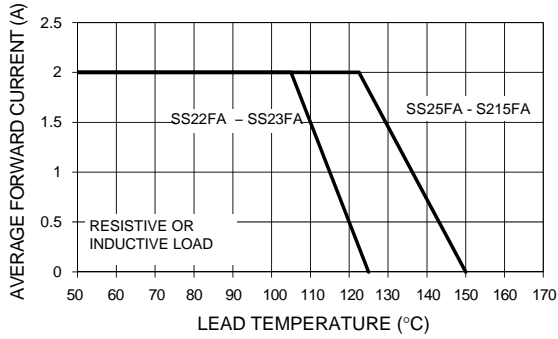

Figure 1. Forward Current Derating Curve

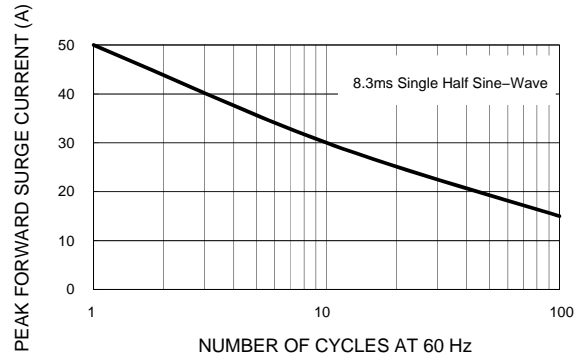

Figure 2. Maximum Non-Repetitive Forward Surge Current

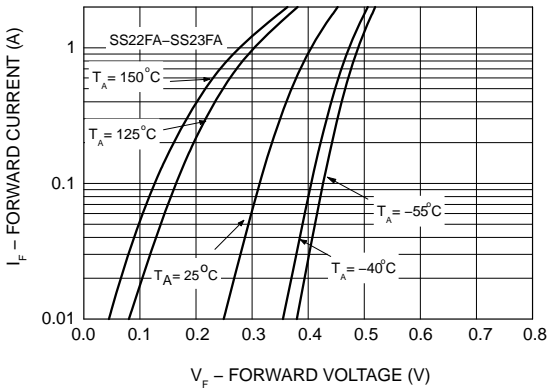

Figure 3. Typical Forward Characteristics

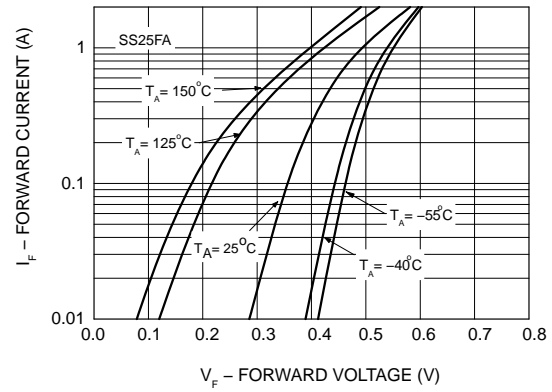

Figure 4. Typical Forward Characteristics

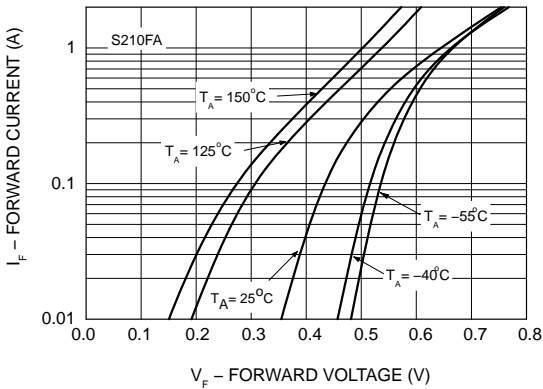

Figure 5. Typical Forward Characteristics

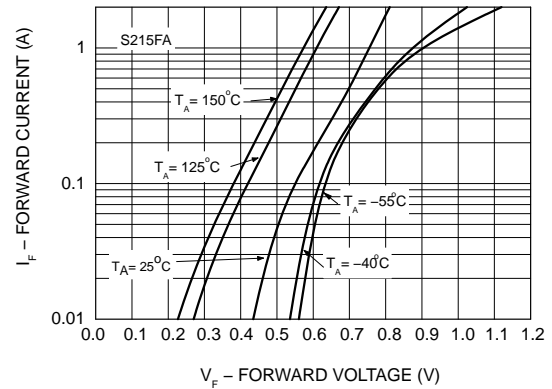

Figure 6. Typical Forward Characteristics

# SS22FA – S215FA

## TYPICAL PERFORMANCE CHARACTERISTICS (continued)

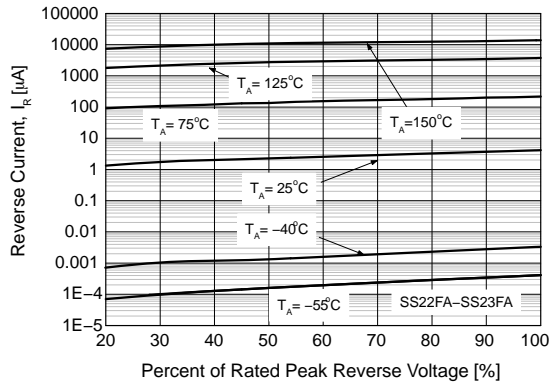

Figure 7. Typical Reverse Characteristics

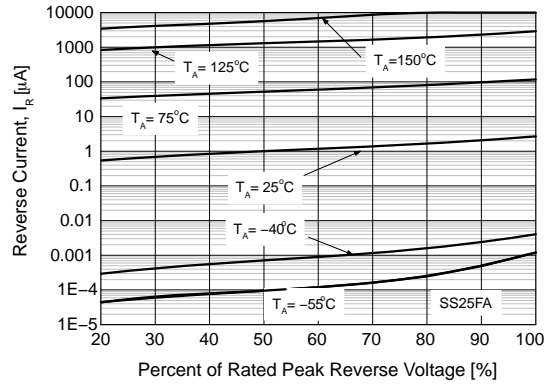

Figure 8. Typical Reverse Characteristics

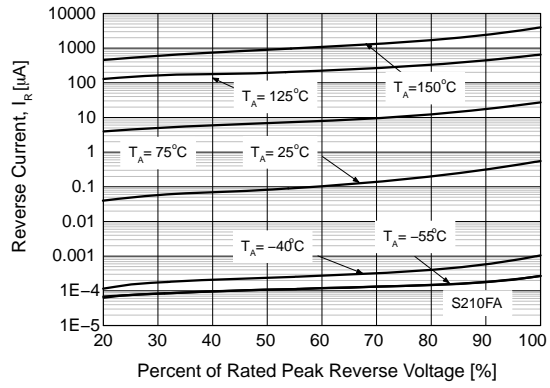

Figure 9. Typical Reverse Characteristics

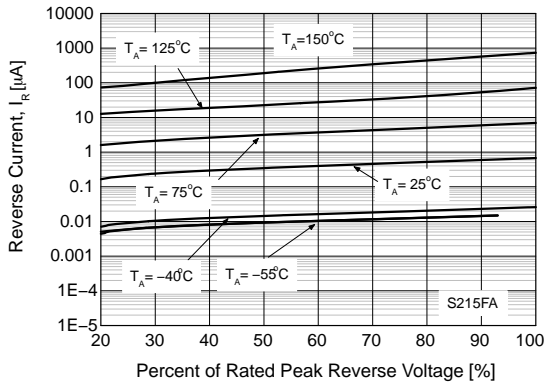

Figure 10. Typical Reverse Characteristics

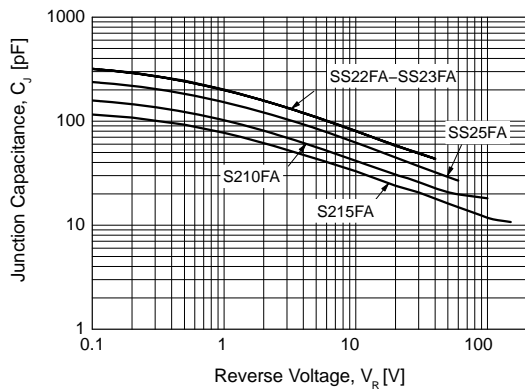
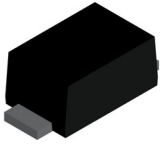

Figure 11. Typical Junction Capacitance

**MECHANICAL CASE OUTLINE**  
**PACKAGE DIMENSIONS**



**SOD-123FA**  
**CASE 425AB**  
**ISSUE A**

DATE 11 AUG 2022

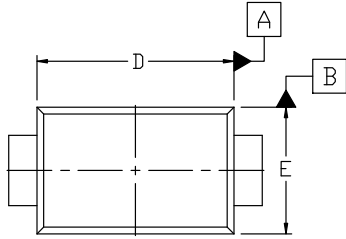

TOP VIEW

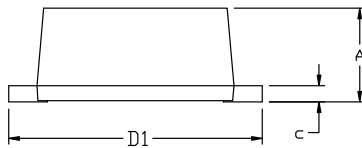

FRONT VIEW

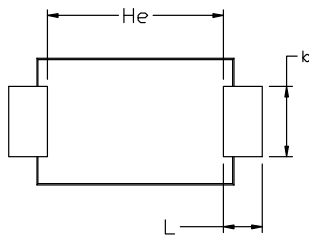

BOTTOM VIEW

NOTES:

1. NO INDUSTRY STANDARD APPLIES TO THIS PACKAGE.
2. ALL DIMENSIONS ARE IN MILLIMETERS.
3. DIMENSIONS ARE EXCLUSIVE OF BURRS, MOLD FLASH AND THE BAR PROTRUSIONS.

DIM	MILLIMETERS		
	MIN.	NOM.	MAX.
A	1.23	1.33	1.43
b	0.80	1.00	1.20
c	0.16	0.23	0.30
D	2.70	2.80	2.90
D1	3.40	3.60	3.80
E	1.70	1.80	1.90
He	2.45	---	2.60
L	0.35	0.60	0.85

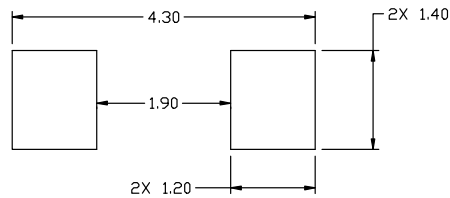

**RECOMMENDED MOUNTING FOOTPRINT\***

\* For additional information on our Pb-Free strategy and soldering details, please download the ON Semiconductor Soldering and Mounting Techniques Reference Manual, SOLDERM/D.

<b>DOCUMENT NUMBER:</b>	<b>98AON13722G</b>	Electronic versions are uncontrolled except when accessed directly from the Document Repository. Printed versions are uncontrolled except when stamped "CONTROLLED COPY" in red.
<b>DESCRIPTION:</b>	<b>SOD-123FA</b>	<b>PAGE 1 OF 1</b>

onsemi and ONSEMI are trademarks of Semiconductor Components Industries, LLC dba onsemi or its subsidiaries in the United States and/or other countries. onsemi reserves the right to make changes without further notice to any products herein. onsemi makes no warranty, representation or guarantee regarding the suitability of its products for any particular purpose, nor does onsemi assume any liability arising out of the application or use of any product or circuit, and specifically disclaims any and all liability, including without limitation special, consequential or incidental damages. onsemi does not convey any license under its patent rights nor the rights of others.

**onsemi**, **Onsemi**, and other names, marks, and brands are registered and/or common law trademarks of Semiconductor Components Industries, LLC dba "**onsemi**" or its affiliates and/or subsidiaries in the United States and/or other countries. **onsemi** owns the rights to a number of patents, trademarks, copyrights, trade secrets, and other intellectual property. A listing of **onsemi**'s product/patent coverage may be accessed at [www.onsemi.com/site/pdf/Patent-Marking.pdf](http://www.onsemi.com/site/pdf/Patent-Marking.pdf). **onsemi** reserves the right to make changes at any time to any products or information herein, without notice. The information herein is provided "as-is" and **onsemi** makes no warranty, representation or guarantee regarding the accuracy of the information, product features, availability, functionality, or suitability of its products for any particular purpose, nor does **onsemi** assume any liability arising out of the application or use of any product or circuit, and specifically disclaims any and all liability, including without limitation special, consequential or incidental damages. Buyer is responsible for its products and applications using **onsemi** products, including compliance with all laws, regulations and safety requirements or standards, regardless of any support or applications information provided by **onsemi**. "Typical" parameters which may be provided in **onsemi** data sheets and/or specifications can and do vary in different applications and actual performance may vary over time. All operating parameters, including "Typicals" must be validated for each customer application by customer's technical experts. **onsemi** does not convey any license under any of its intellectual property rights nor the rights of others. **onsemi** products are not designed, intended, or authorized for use as a critical component in life support systems or any FDA Class 3 medical devices or medical devices with a same or similar classification in a foreign jurisdiction or any devices intended for implantation in the human body. Should Buyer purchase or use **onsemi** products for any such unintended or unauthorized application, Buyer shall indemnify and hold **onsemi** and its officers, employees, subsidiaries, affiliates, and distributors harmless against all claims, costs, damages, and expenses, and reasonable attorney fees arising out of, directly or indirectly, any claim of personal injury or death associated with such unintended or unauthorized use, even if such claim alleges that **onsemi** was negligent regarding the design or manufacture of the part. **onsemi** is an Equal Opportunity/Affirmative Action Employer. This literature is subject to all applicable copyright laws and is not for resale in any manner.

## PUBLICATION ORDERING INFORMATION

### LITERATURE FULFILLMENT:

Email Requests to: [orderlit@onsemi.com](mailto:orderlit@onsemi.com)

**onsemi Website:** [www.onsemi.com](http://www.onsemi.com)

### TECHNICAL SUPPORT

**North American Technical Support:**

Voice Mail: 1 800-282-9855 Toll Free USA/Canada

Phone: 011 421 33 790 2910

**Europe, Middle East and Africa Technical Support:**

Phone: 00421 33 790 2910

For additional information, please contact your local Sales Representative