

GaAs MMIC I/Q DOWNCONVERTER 5.6 - 8.6 GHz



Typical Applications

The HMC951LP4E is ideal for:

- Point-to-Point and Point-to-Multi-Point Radio
- Military Radar, EW & ELINT
- Satellite Communications

Features

Conversion Gain: 13 dB

Image Rejection: 20 dB

LO to RF Isolation: 48 dB

Noise Figure: 2.3 dB

Input IP3: 3 dBm

24 Lead 4x4 mm SMT Package: 16 mm²

General Description

The HMC951LP4E is a compact GaAs MMIC I/Q downconverter in a leadless RoHS compliant SMT package. This device provides a small signal conversion gain of 13 dB with a noise figure of 2 dB and 25 dB of image rejection across the frequency band. The HMC951LP4E utilizes an LNA followed by an image reject mixer which is driven by an LO buffer amplifier. The image reject mixer eliminates the need for a filter following the LNA, and removes thermal noise at the image frequency. I and Q mixer outputs are provided and an external 90° hybrid is needed to select the required sideband. The HMC951LP4E is a much smaller alternative to hybrid style image reject mixer downconverter assemblies, and is compatible with surface mount manufacturing techniques.

Functional Diagram

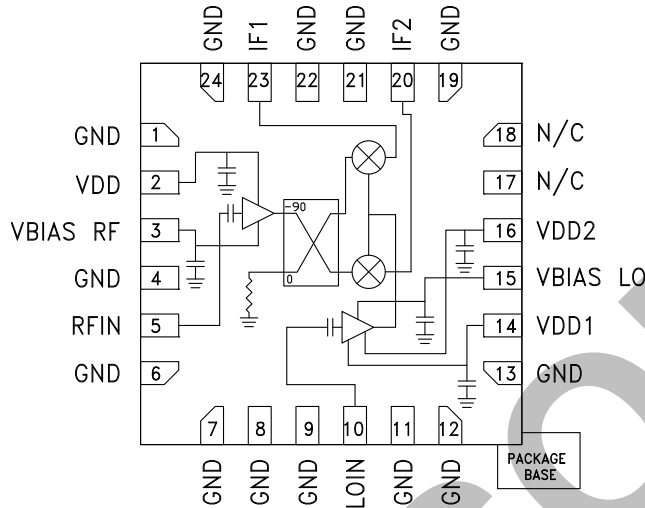

Electrical Specifications, $T_A = +25^\circ\text{C}$, $IF = 1000\text{ MHz}$, $LO = 0\text{ dBm}$, $V_{dd} = 5\text{ V LSB}$ [1]

Parameter	Min.	Typ.	Max.	Units
Frequency Range, RF		5.6 - 8.6		GHz
Frequency Range, LO		3 - 12.1		GHz
Frequency Range, IF		DC - 3.5		GHz
Conversion Gain (As IRM)	10	13		dB
Noise Figure		2		dB
Image Rejection	13	25		dBc
1 dB Compression (Input)		-3		dBm
LO to RF Isolation	40	48		dB
LO to IF Isolation	20	30		dB
IP3 (Input)		3		dBm
Amplitude Balance [2]		1		dB
Phase Balance [2]		-7		deg
Total Supply Current @LO = 0dBm [3]				
I _{dd}		55	60	mA
I _{dd1}		78	85	
I _{dd2}		97	105	

[1] Data taken as IRM with external IF 90° Hybrid.

[2] Data taken without external 90° hybrid, IF = 1000 MHz.

[3] Current is set by the external bias resistor. I_{dq} of LO Amp = 140 mA.

GaAs MMIC I/Q DOWNCONVERTER
5.6 - 8.6 GHz



Data Taken As IRM With External IF 90° Hybrid, IF = 1000 MHz

Conversion Gain LSB vs. Temperature

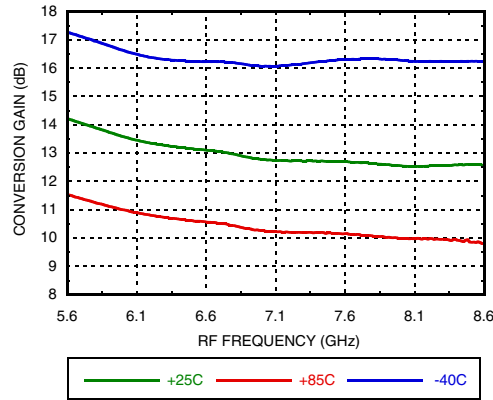

Conversion Gain LSB vs. LO Drive

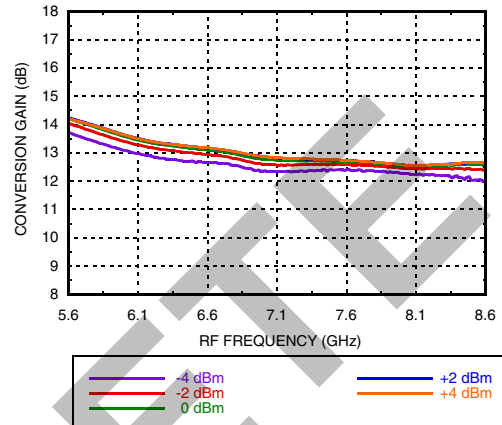
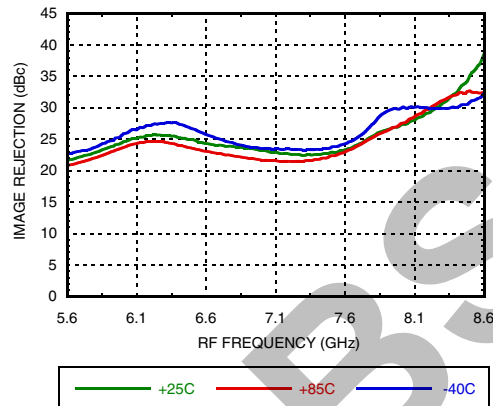
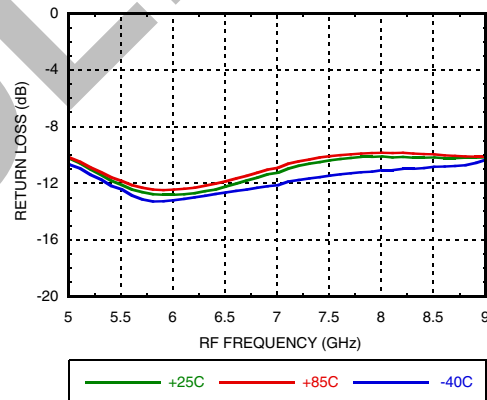

Image Rejection LSB vs. Temperature



RF Return Loss vs. Temperature



LO Return Loss vs. Temperature

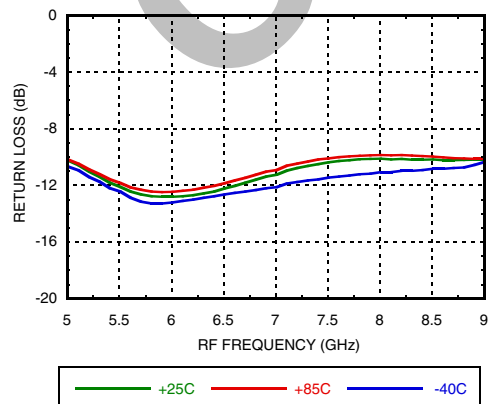

IF Return Loss [1]

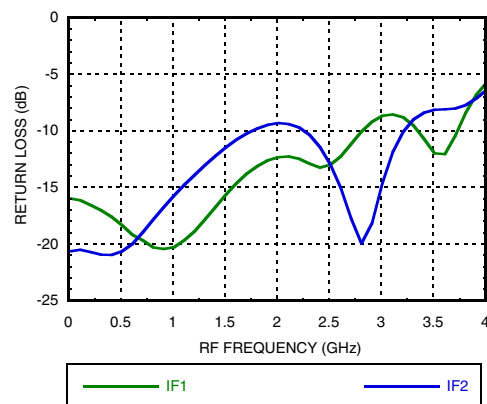

[1] Data taken without external 90° hybrid.

Information furnished by Analog Devices is believed to be accurate and reliable. However, no responsibility is assumed by Analog Devices for its use, nor for any infringements of patents or other rights of third parties that may result from its use. Specifications subject to change without notice. No license is granted by implication or otherwise under any patent or patent rights of Analog Devices. Trademarks and registered trademarks are the property of their respective owners.

For price, delivery, and to place orders: Analog Devices, Inc., One Technology Way, P.O. Box 9106, Norwood, MA 02062-9106 Phone: 781-329-4700 • Order online at www.analog.com Application Support: Phone: 1-800-ANALOG-D

**GaAs MMIC I/Q DOWNCONVERTER
5.6 - 8.6 GHz**



Data Taken as IRM With External IF 90° Hybrid, IF = 1000 MHz

Isolations

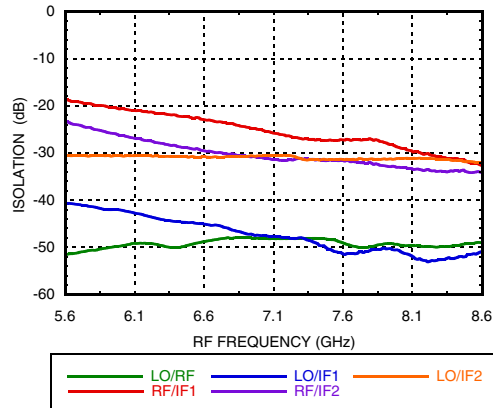

Input P1dB LSB vs. Temperature

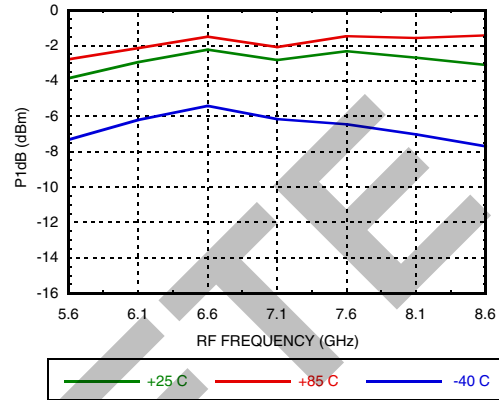

Input IP3, LSB vs. Temperature

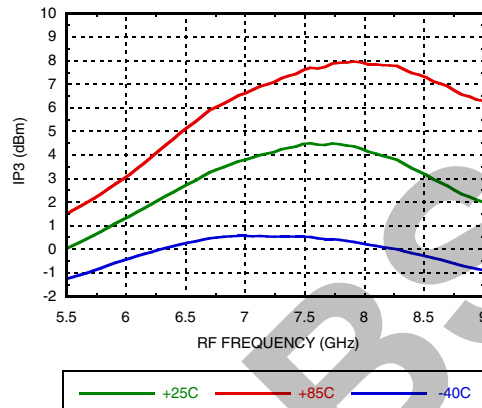

Input IP3, LSB vs. LO Drive

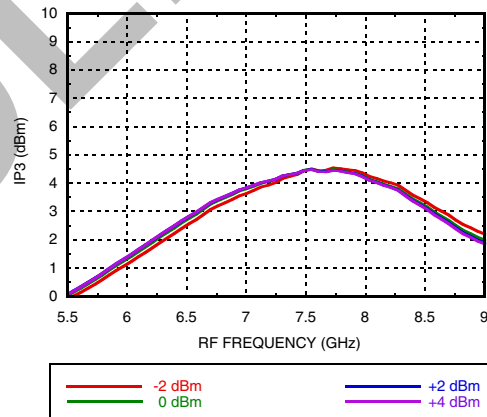

**Noise Figure vs. Temperature,
IF Frequency = 1000 MHz**

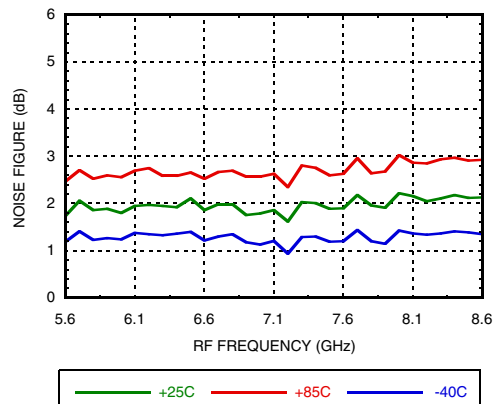

Information furnished by Analog Devices is believed to be accurate and reliable. However, no responsibility is assumed by Analog Devices for its use, nor for any infringements of patents or other rights of third parties that may result from its use. Specifications subject to change without notice. No license is granted by implication or otherwise under any patent or patent rights of Analog Devices. Trademarks and registered trademarks are the property of their respective owners.

For price, delivery, and to place orders: Analog Devices, Inc., One Technology Way, P.O. Box 9106, Norwood, MA 02062-9106 Phone: 781-329-4700 • Order online at www.analog.com Application Support: Phone: 1-800-ANALOG-D



Quadrature Channel Data Taken Without IF 90° Hybrid, IF = 1000 MHz

IF Bandwidth

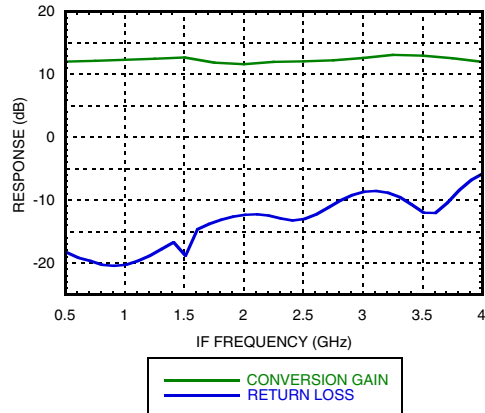

Amplitude Balance vs. LO Drive [1]

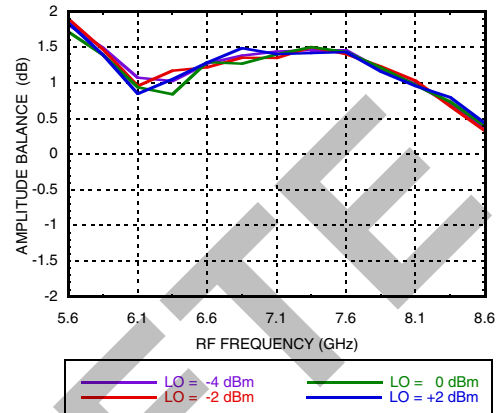

Phase Balance vs. LO Drive [1]

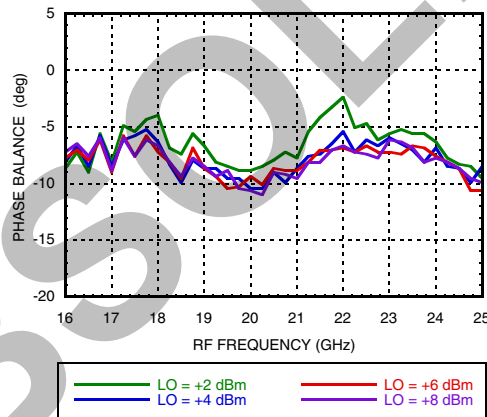

[1] Data taken with IF = 1000 MHz

Information furnished by Analog Devices is believed to be accurate and reliable. However, no responsibility is assumed by Analog Devices for its use, nor for any infringements of patents or other rights of third parties that may result from its use. Specifications subject to change without notice. No license is granted by implication or otherwise under any patent or patent rights of Analog Devices. Trademarks and registered trademarks are the property of their respective owners.

For price, delivery, and to place orders: Analog Devices, Inc., One Technology Way, P.O. Box 9106, Norwood, MA 02062-9106 Phone: 781-329-4700 • Order online at www.analog.com Application Support: Phone: 1-800-ANALOG-D

GaAs MMIC I/Q DOWNCONVERTER
5.6 - 8.6 GHz



Data Taken as IRM With External IF 90° Hybrid, IF = 1000 MHz

Conversion Gain, USB vs. Temperature

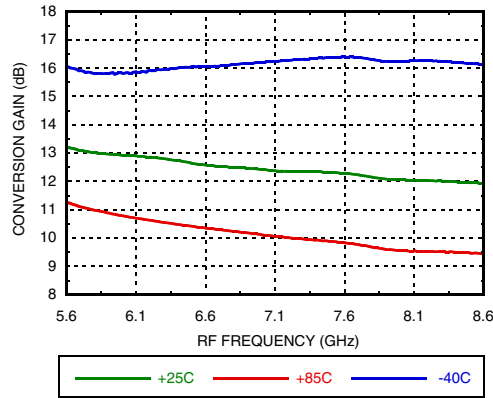

Conversion Gain, USB vs. LO Drive

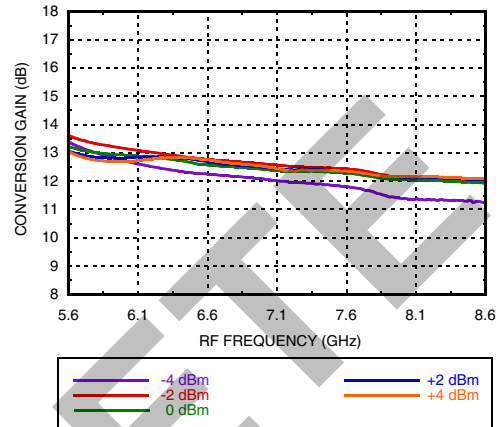
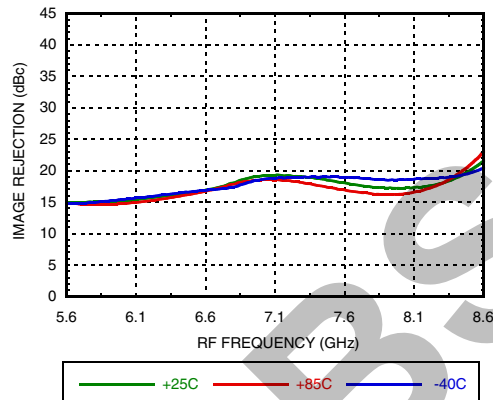
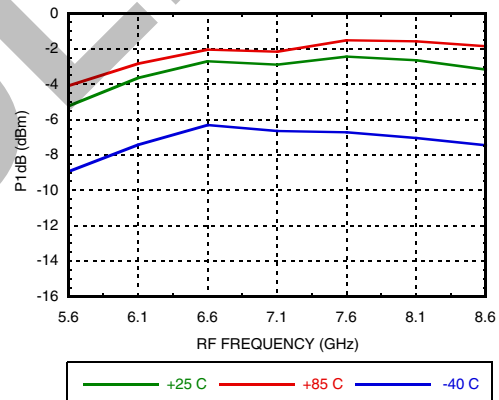

Image Rejection USB vs. Temperature



Input P1dB, USB vs. Temperature



Input IP3, USB vs. Temperature

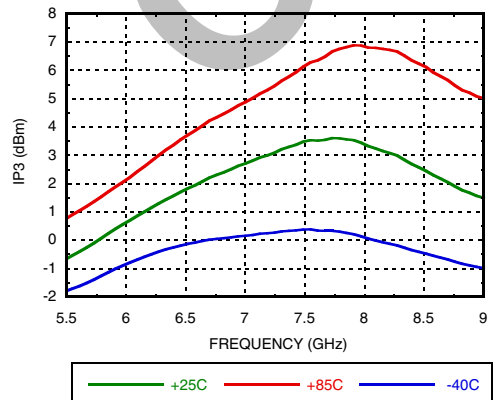

Input IP3, USB vs. LO Drive

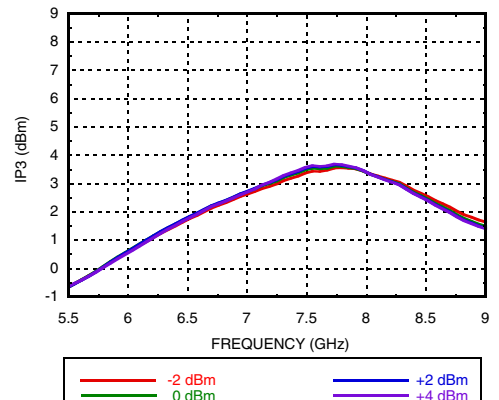

Information furnished by Analog Devices is believed to be accurate and reliable. However, no responsibility is assumed by Analog Devices for its use, nor for any infringements of patents or other rights of third parties that may result from its use. Specifications subject to change without notice. No license is granted by implication or otherwise under any patent or patent rights of Analog Devices. Trademarks and registered trademarks are the property of their respective owners.

For price, delivery, and to place orders: Analog Devices, Inc., One Technology Way, P.O. Box 9106, Norwood, MA 02062-9106 Phone: 781-329-4700 • Order online at www.analog.com Application Support: Phone: 1-800-ANALOG-D



Data Taken as IRM With External IF 90° Hybrid, IF = 2000 MHz

Conversion Gain, LSB vs. Temperature

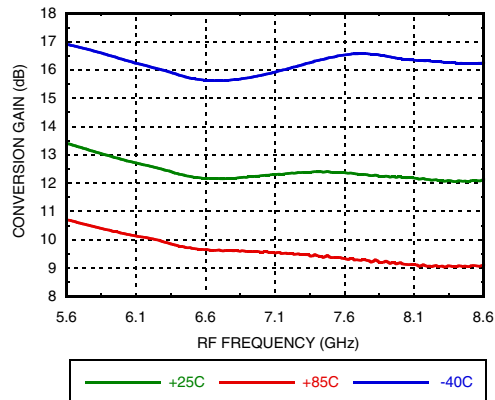

Conversion Gain, LSB vs. LO Drive

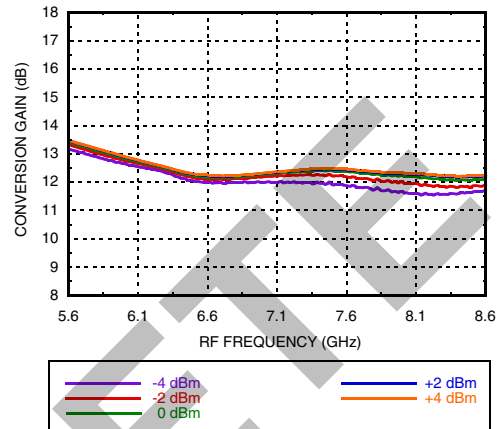
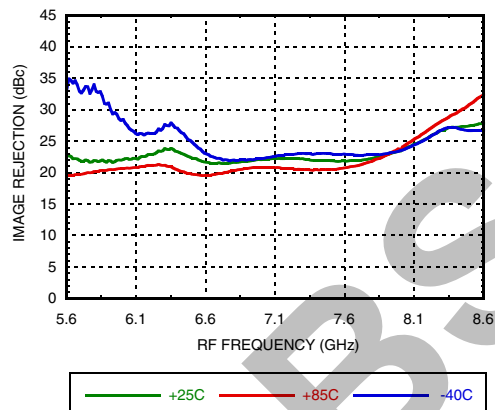
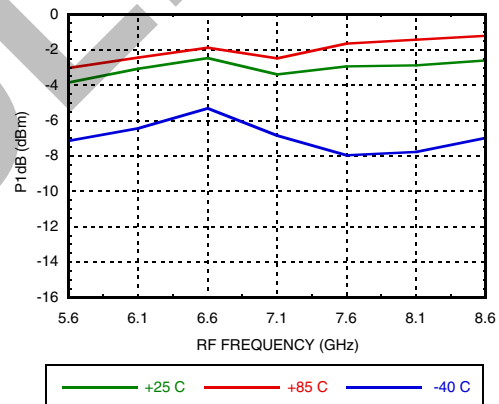

Image Rejection LSB vs. Temperature



Input P1dB, LSB vs. Temperature



Input IP3, LSB vs. Temperature

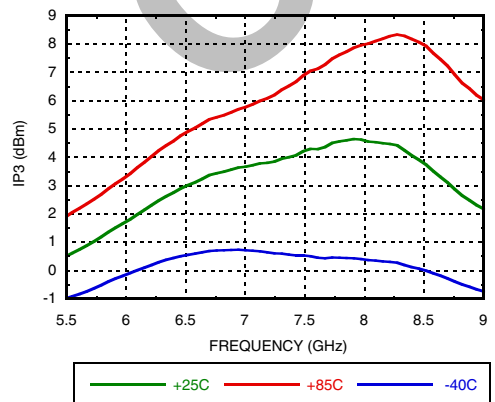

Input IP3, LSB vs. LO Drive

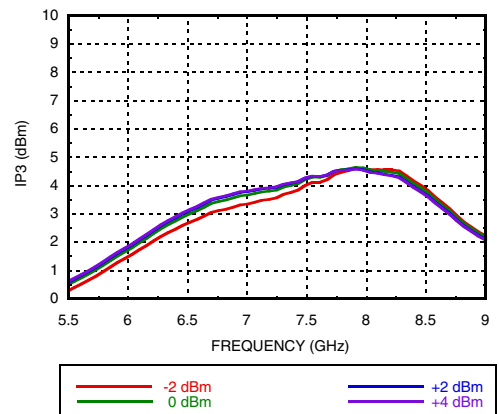

Information furnished by Analog Devices is believed to be accurate and reliable. However, no responsibility is assumed by Analog Devices for its use, nor for any infringements of patents or other rights of third parties that may result from its use. Specifications subject to change without notice. No license is granted by implication or otherwise under any patent or patent rights of Analog Devices. Trademarks and registered trademarks are the property of their respective owners.

For price, delivery, and to place orders: Analog Devices, Inc., One Technology Way, P.O. Box 9106, Norwood, MA 02062-9106 Phone: 781-329-4700 • Order online at www.analog.com Application Support: Phone: 1-800-ANALOG-D

GaAs MMIC I/Q DOWNCONVERTER
5.6 - 8.6 GHz



Data Taken as IRM With External IF 90° Hybrid, IF = 2000 MHz

Conversion Gain, USB vs. Temperature

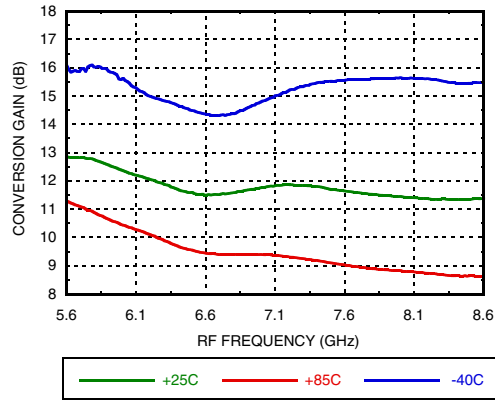

Conversion Gain, USB vs. LO Drive

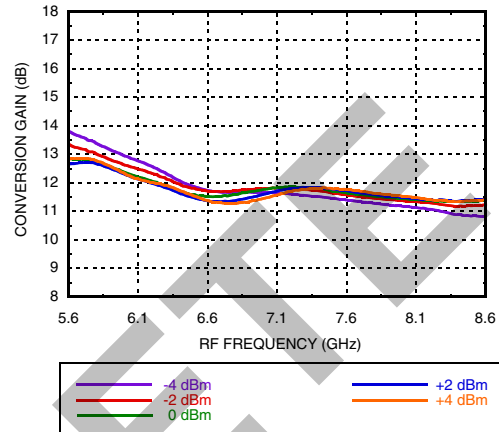
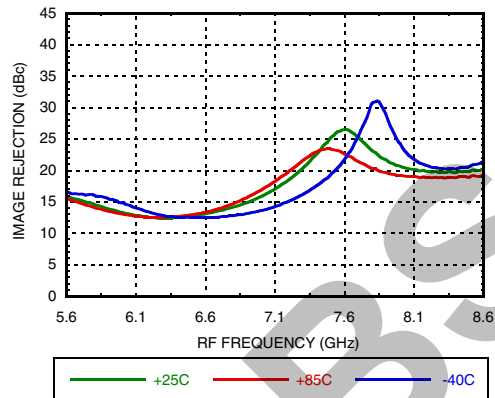
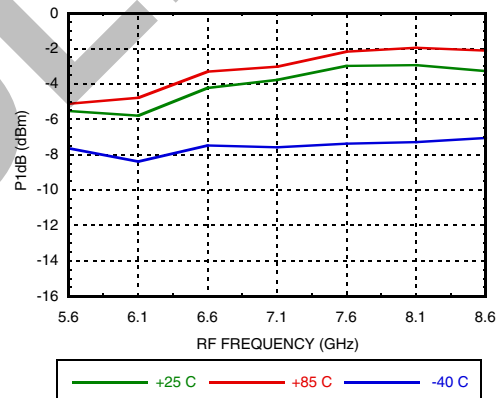

Image Rejection USB vs. Temperature



Input P1dB, USB vs. Temperature



Input IP3, USB vs. Temperature

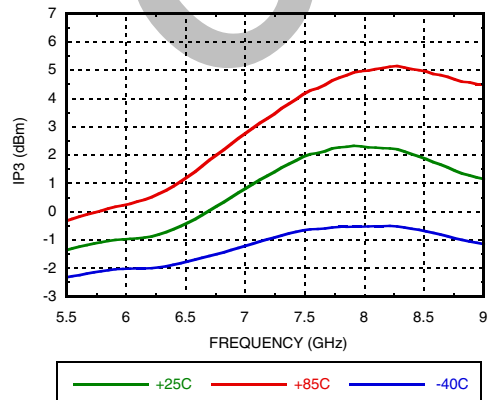

Input IP3, USB vs. LO Drive

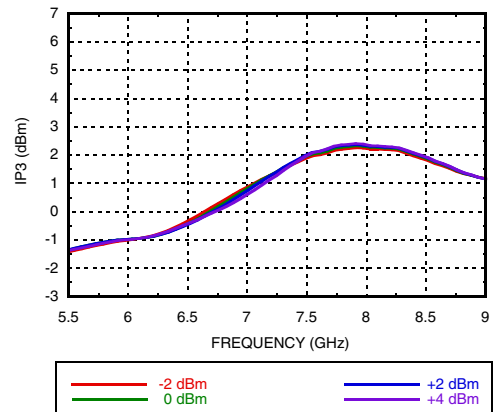

Information furnished by Analog Devices is believed to be accurate and reliable. However, no responsibility is assumed by Analog Devices for its use, nor for any infringements of patents or other rights of third parties that may result from its use. Specifications subject to change without notice. No license is granted by implication or otherwise under any patent or patent rights of Analog Devices. Trademarks and registered trademarks are the property of their respective owners.

For price, delivery, and to place orders: Analog Devices, Inc., One Technology Way, P.O. Box 9106, Norwood, MA 02062-9106 Phone: 781-329-4700 • Order online at www.analog.com Application Support: Phone: 1-800-ANALOG-D



MxN Spurious Outputs

mRF	nLO				
	0	1	2	3	4
0	x	34	59	67	56
1	23	0	52	71	80
2	64	50	56	91	95
3	92	93	53	45	90
4	90	115	102	67	64

RF = 6.1 GHz @ -20 dBm
LO = 7.1 GHz @ 0 dBm
Data taken without IF hybrid
All values in dBc below IF power level (LO - RF = 1 GHz)

Absolute Maximum Ratings

RF	+15 dBm
LO Drive	+20 dBm
Vdd	+5.5V
Channel Temperature	150 °C
Continuous P _{diss} (T=85°C) (derate 21.6 mW/°C above 85°C)	1.4 W
Thermal Resistance (R _{TH}) (channel to package bottom)	46.3 °C/W
Storage Temperature	-65 to +150 °C
Operating Temperature	-55 to +85 °C
ESD Sensitivity (HBM)	Class 1A



ELECTROSTATIC SENSITIVE DEVICE
OBSERVE HANDLING PRECAUTIONS

Outline Drawing

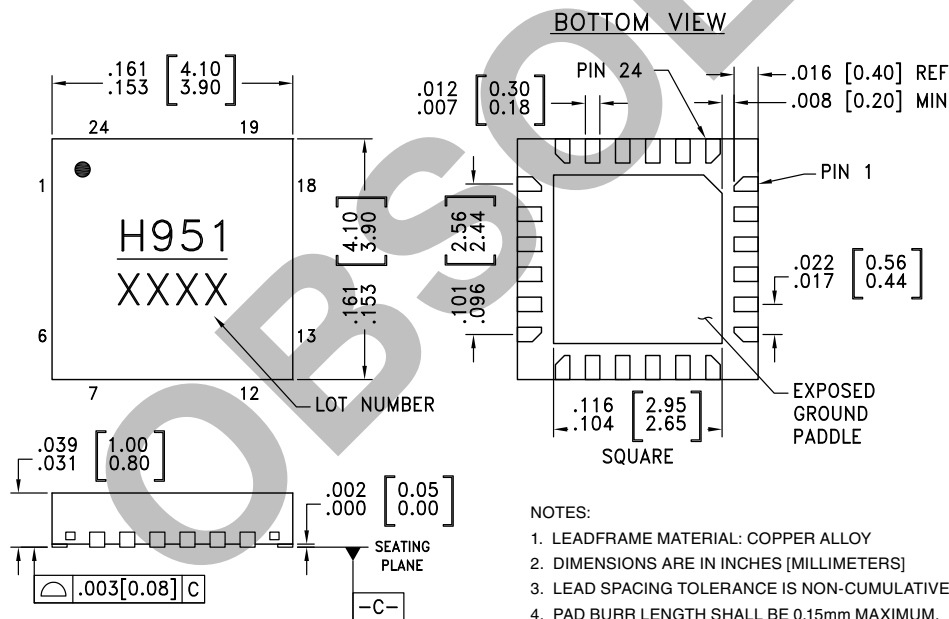

NOTES:

- LEADFRAME MATERIAL: COPPER ALLOY
- DIMENSIONS ARE IN INCHES [MILLIMETERS]
- LEAD SPACING TOLERANCE IS NON-CUMULATIVE.
- PAD BURR LENGTH SHALL BE 0.15mm MAXIMUM.
PAD BURR HEIGHT SHALL BE 0.05mm MAXIMUM.
- PACKAGE WARP SHALL NOT EXCEED 0.05mm.
- ALL GROUND LEADS AND GROUND PADDLE MUST BE SOLDERED TO PCB RF GROUND.
- REFER TO HITTITE APPLICATION NOTE FOR SUGGESTED LAND PATTERN.

Package Information

Part Number	Package Body Material	Lead Finish	MSL Rating	Package Marking ^[1]
HMC951LP4E	RoHS-compliant Low Stress Injection Molded Plastic	100% matte Sn	MSL1 ^[2]	H951 XXXX

[1] 4-Digit lot number XXXX

[2] Max peak reflow temperature of 260 °C



Pin Descriptions

Pin Number	Function	Description	Interface Schematic
1, 4, 6, 7, 8, 9, 11, 12, 13, 19, 21, 22, 24	GND	These pins and package bottom must be connected to RF/DC ground	
2	VDD	Power supply voltage for RF Amplifier. Bypass capacitors are required. See application circuit	
3	VBIAS_RF	This pin is used to set the DC current of the RF amplifier by selection of the external bias resistor. See application circuit.	
5	RFIN	This pin is the RF input pin. It is AC coupled and matched to 50 Ohms	
10	LOIN	This pin is the LO input pin. It is AC coupled and matched to 50 Ohms	
14, 16	VDD1, VDD2	Power supply voltages for LO Amplifier. Bypass capacitors are required. See application circuit	
15	VBIAS_LO	This pin is used to set the DC current of the LO amplifier by selection of the external bias resistor. See application circuit.	
17, 18	N/C	These pins are not connected internally; however, all data shown herein was measured with these pins connected to RF/DC ground externally.	
20	IF2	This pin is DC coupled. For applications not requiring operations to DC this port should be DC blocked externally using a series capacitor whose value has been chosen to pass the necessary frequency range. For operation to DC, this pin must not sink / source more than 3 mA of current or part non-function and possible failure will result.	
23	IF1		



Typical Application Circuit

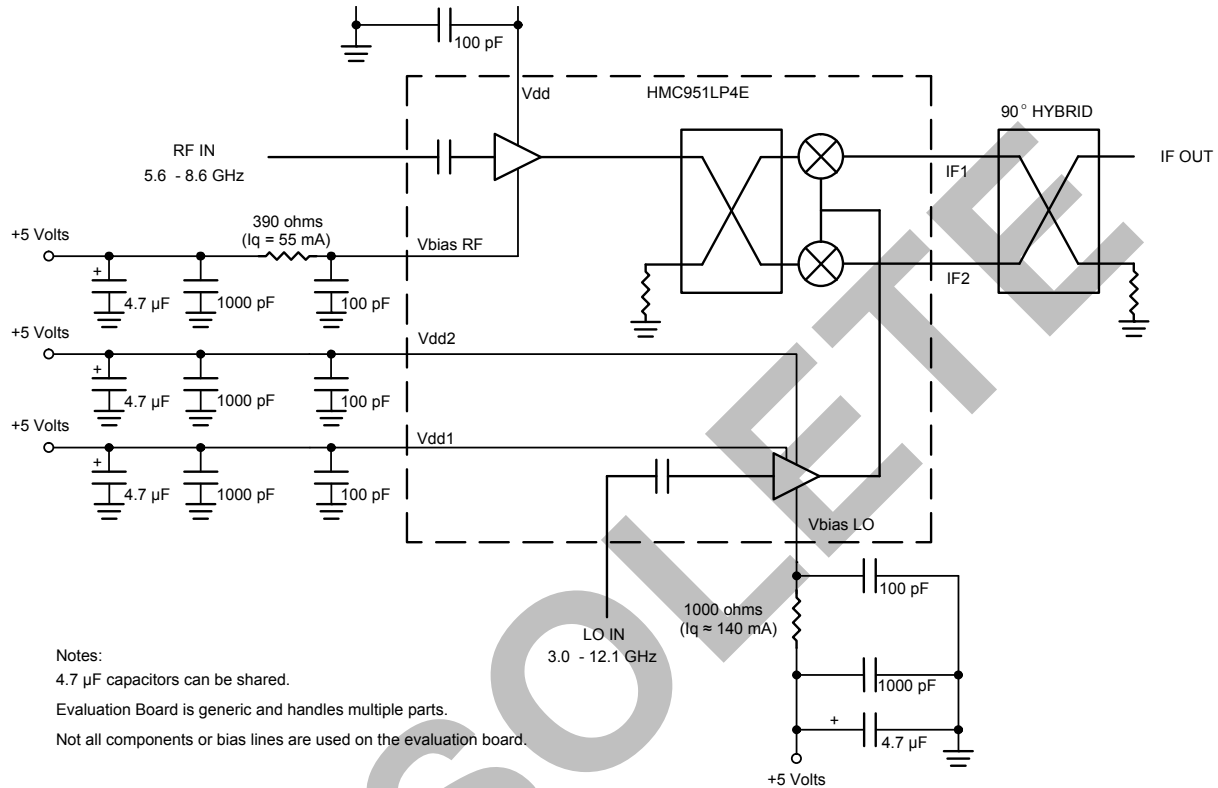

Notes:
 4.7 μF capacitors can be shared.
 Evaluation Board is generic and handles multiple parts.
 Not all components or bias lines are used on the evaluation board.

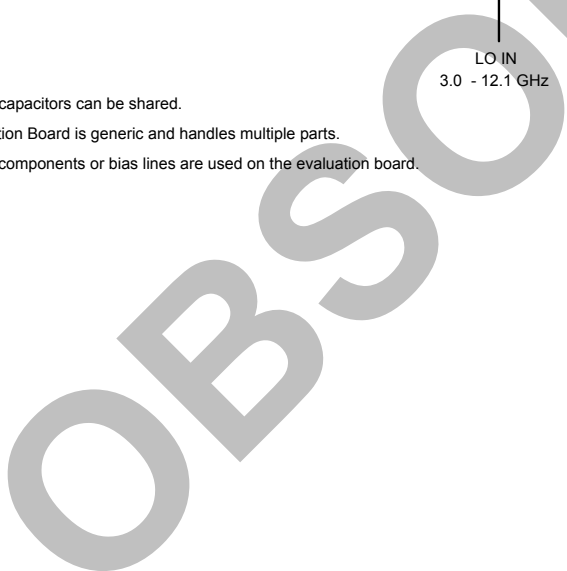

Information furnished by Analog Devices is believed to be accurate and reliable. However, no responsibility is assumed by Analog Devices for its use, nor for any infringements of patents or other rights of third parties that may result from its use. Specifications subject to change without notice. No license is granted by implication or otherwise under any patent or patent rights of Analog Devices. Trademarks and registered trademarks are the property of their respective owners.

For price, delivery, and to place orders: Analog Devices, Inc., One Technology Way, P.O. Box 9106, Norwood, MA 02062-9106 Phone: 781-329-4700 • Order online at www.analog.com Application Support: Phone: 1-800-ANALOG-D



Evaluation PCB

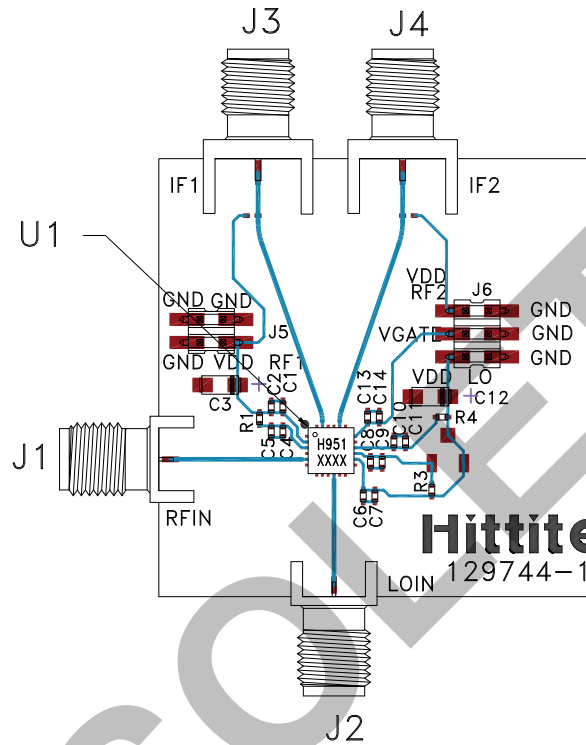

List of Materials for Evaluation PCB 131372 [1]

Item	Description
J1, J2	PCB Mount SMA RF Connector, SRI
J3, J4	PCB Mount SMA Connector, Johnson
J5, J6	DC Pins
C1, C4, C6, C8, C10, C13	100 pF Capacitor, 0402 Pkg.
C2, C5, C7, C9, C11, C14	1000 pF Capacitor, 0402 Pkg.
C3, C12	4.7 μF Capacitor, 1206 Pkg.
R1	390 Ohm Resistor, 0402 Pkg.
R3	1 kOhm Resistor, 0402 Pkg.
R4	0 Ohm Resistor, 0402 Pkg.
U1	HMC951LP4E
PCB [2]	129744 Evaluation Board

[1] Reference this number when ordering complete evaluation PCB

[2] Circuit Board Material: Rogers 4350

The circuit board used in the application should use RF circuit design techniques. Signal lines should have 50 Ohm impedance while the package ground leads and exposed paddle should be connected directly to the ground plane similar to that shown. A sufficient number of via holes should be used to connect the top and bottom ground planes. The evaluation circuit board shown is available from Hittite upon request.

Information furnished by Analog Devices is believed to be accurate and reliable. However, no responsibility is assumed by Analog Devices for its use, nor for any infringements of patents or other rights of third parties that may result from its use. Specifications subject to change without notice. No license is granted by implication or otherwise under any patent or patent rights of Analog Devices. Trademarks and registered trademarks are the property of their respective owners.

For price, delivery, and to place orders: Analog Devices, Inc., One Technology Way, P.O. Box 9106, Norwood, MA 02062-9106 Phone: 781-329-4700 • Order online at www.analog.com Application Support: Phone: 1-800-ANALOG-D

**Notes:**

OBSOLETE