

**SINGLE-PHASE GLASS PASSIVATED
SILICON BRIDGE RECTIFIER**

VOLTAGE RANGE 50 to 1000 Volts CURRENT 10 Amperes

FEATURES

- * Low leakage
- * Low forward voltage
- * Mounting position : Any
- * Surge overload rating: 150 Amperes peak
- * Ideal for printed circuit boards
- * MSL: Level 1

MECHANICAL DATA

- * Epoxy: Device has UL flammability classification 94V-O

RS-10MLS

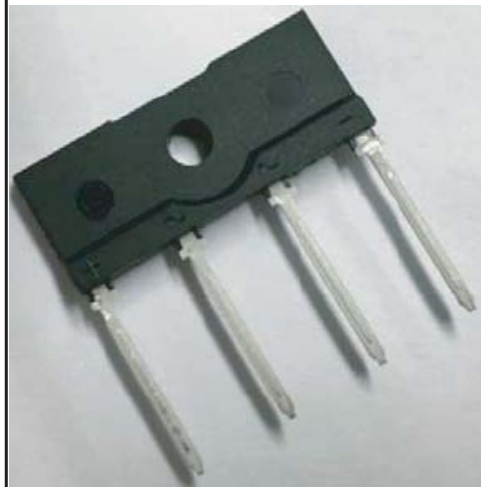

MAXIMUM RATINGS AND ELECTRICAL CHARACTERISTICS

Ratings at 25 °C ambient temperature unless otherwise specified.
resistive or inductive load.

MAXIMUM CHARACTERISTICS (@ TA = 25°C unless otherwise noted)

CHARACTERISTICS	SYMBOL	RS1001MLS	RS1002MLS	RS1003MLS	RS1004MLS	RS1005MLS	RS1006MLS	RS1007MLS	UNITS
Maximum Recurrent Peak Reverse Voltage	V _{RRM}	50	100	200	400	600	800	1000	Volts
Maximum RMS Bridge Input Voltage	V _{RMS}	35	70	140	280	420	560	700	Volts
Maximum DC Blocking Voltage	V _{DC}	50	100	200	400	600	800	1000	Volts
Maximum Average Forward Rectified Output Current at T _c =95 °C degree with heatsink	I _o	10							Amps
Peak Forward Surge Current 8.3 ms single half sine-wave superimposed on rated load	I _{FSM}	150							Amps
Typical Current Square Time	I ² T	93.37							A ² S
Insulation voltage	V _{iso}	3000							Volts
Typical Thermal Resistance from junction to ambient	R _{θJA}	28							°C/W
Typical Thermal Resistance from junction to case	R _{θJC}	2.8							
Operating and Storage Temperature Range	T _J ,T _{STG}	-55 to + 150							°C

ELECTRICAL CHARACTERISTICS (@ TA = 25°C unless otherwise noted)

CHARACTERISTICS	SYMBOL	RS1001MLS	RS1002MLS	RS1003MLS	RS1004MLS	RS1005MLS	RS1006MLS	RS1007MLS	UNITS
Maximum Forward Voltage Drop per element at 5.0A DC	V _F	1.1							Volts
Maximum Reverse Current at Rated DC Blocking Voltage per element	@TA=25 °C	0.2							μAmps
	@TC=100 °C	50							μAmps

Note: "Fully ROHS compliant", "100% Sn plating (Pb-free)".

RATING AND CHARACTERISTICS CURVES (RS1001MLS THRU RS1007MLS)

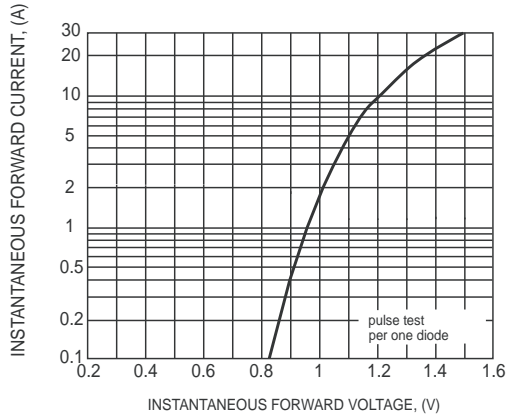

FIG.1 MAXIMUM INSTANTANEOUS FORWARD CHARACTERISTICS

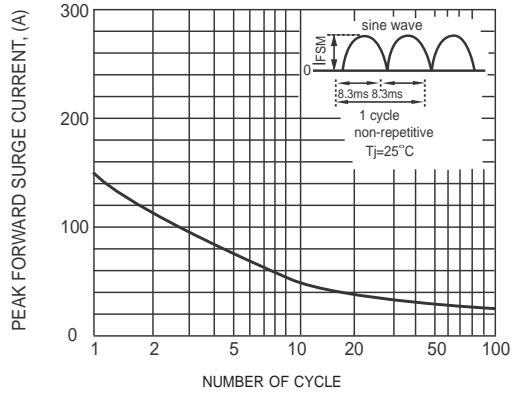

FIG.2 SURGE FORWARD CURRENT CAPABILITY

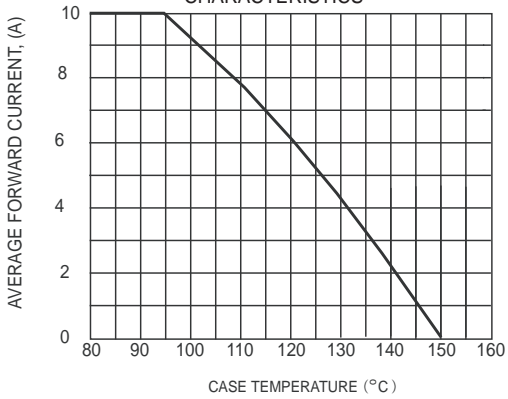

FIG.3 TYPICAL FORWARD CURRENT DERATING CURVE

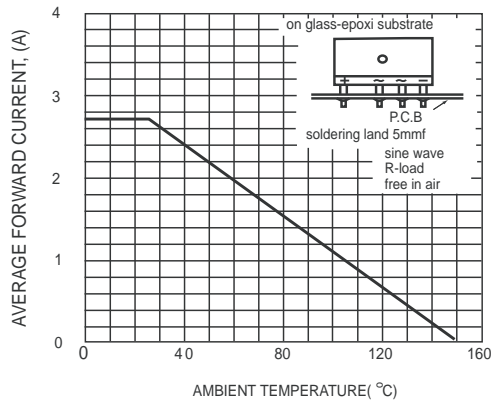
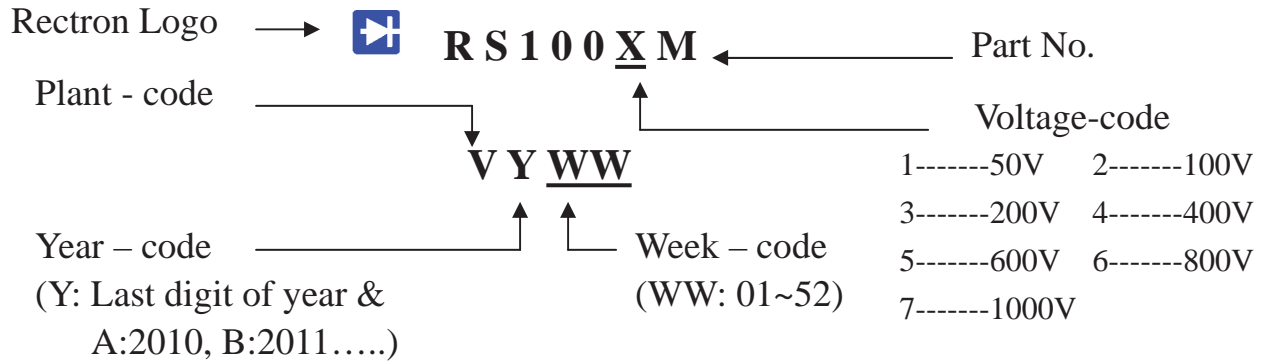
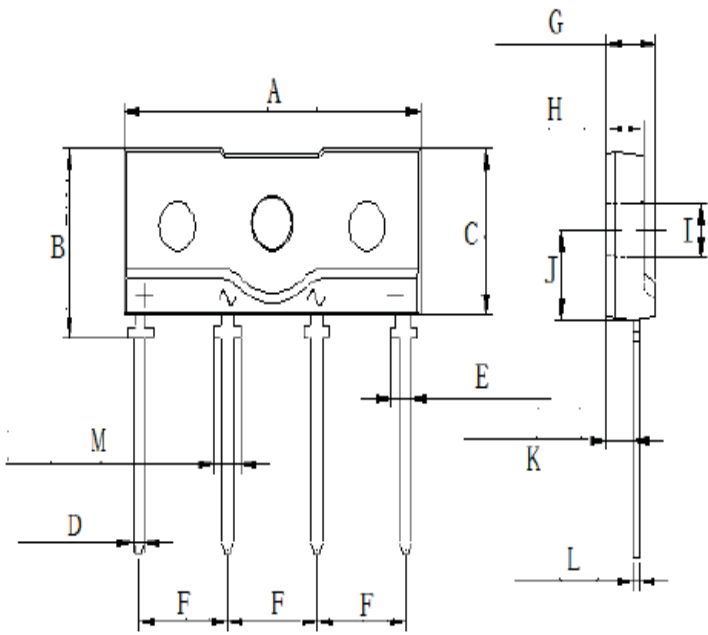

FIG.4 TYPICAL FORWARD CURRENT DERATING CURVE

Marking Description



RS-10MLS



Dimensions in inches and millimeters

Dim	Min	Max
A	24.7	25.3
B	11.4	12.0
C	10.0	10.6
D	0.9	1.1
E	1.75(MAX)	
F	7.3	7.7
G	3.9	4.5
H	2.9	3.9
I	3.1	3.4
J	5.4	6.0
K	2.0	2.6
L	0.4	0.6
M	2.1	2.3

PACKAGING OF DIODE AND BRIDGE RECTIFIERS

BULK PACK

PACKAGE	PACKING CODE	EA PER BOX	INNER BOX SIZE (mm)	CARTON SIZE (mm)	EA PER CARTON	GROSS WEIGHT(Kg)
RS-10MLS	-B	250	300*138*35	319*296*165	2000	9.7

DISCLAIMER NOTICE

Rectron Inc reserves the right to make changes without notice to any product specification herein, to make corrections, modifications, enhancements or other changes. Rectron Inc or anyone on its behalf assumes no responsibility or liability for any errors or inaccuracies. Data sheet specifications and its information contained are intended to provide a product description only. "Typical" parameters which may be included on RECTRON data sheets and/ or specifications can and do vary in different applications and actual performance may vary over time. Rectron Inc does not assume any liability arising out of the application or use of any product or circuit.

Rectron products are not designed, intended or authorized for use in medical, life-saving implant or other applications intended for life-sustaining or other related applications where a failure or malfunction of component or circuitry may directly or indirectly cause injury or threaten a life without expressed written approval of Rectron Inc. Customers using or selling Rectron components for use in such applications do so at their own risk and shall agree to fully indemnify Rectron Inc and its subsidiaries harmless against all claims, damages and expenditures.