

# N-Channel RF Amplifier

## MMBF5484, MMBF5485, MMBF5486

This device is designed primarily for electronic switching applications such as low On Resistance analog switching. Sourced from Process 50.

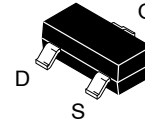

NOTE: Source & Drain are interchangeable

SOT-23  
CASE 318-08

### ABSOLUTE MAXIMUM RATINGS\* (T<sub>A</sub> = 25°C unless otherwise noted)

Symbol	Rating	Value	Unit
V <sub>DG</sub>	Drain-Gate Voltage	25	V
V <sub>GS</sub>	Gate-Source Voltage	-25	V
I <sub>GF</sub>	Forward Gate Current	10	mA
T <sub>J</sub> , T <sub>stg</sub>	Operating and Storage Junction Temperature Range	-55 to +150	°C

Stresses exceeding those listed in the Maximum Ratings table may damage the device. If any of these limits are exceeded, device functionality should not be assumed, damage may occur and reliability may be affected.

\*These rating are limiting values above which the serviceability of any semiconductor device may be impaired.

1. These rating are based on a maximum junction temperature of 150°C.
2. These are steady state limits. The factory should be consulted on applications involving pulsed or low duty cycle operations.

### THERMAL CHARACTERISTICS (T<sub>A</sub> = 25°C unless otherwise noted)

Symbol	Characteristic	Max	Unit
		*MMBF5484-5486	
P <sub>D</sub>	Total Device Dissipation Derate above 25°C	225	mW
		1.8	mW/°C
R <sub>θJC</sub>	Thermal Resistance, Junction to Case	-	°C/W
R <sub>θJA</sub>	Thermal Resistance, Junction to Ambient	556	°C/W

\*Device mounted on FR-4 PCB 1.6" x 1.6" x 0.06".

### MARKING DIAGRAM

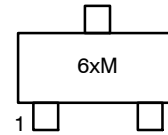

6x = Device Code (x = B, M, H)  
M = Date Code

### ORDERING INFORMATION

Device	Package	Shipping†
MMBF5484	SOT-23 (Pb-Free)	3000 Tape & Reel
MMBF5484		
MMBF5484		

†For information on tape and reel specifications, including part orientation and tape sizes, please refer to our Tape and Reel Packaging Specifications Brochure, BRD8011/D.

# MMBF5484, MMBF5485, MMBF5486

## ELECTRICAL CHARACTERISTICS ( $T_J = 25^\circ\text{C}$ unless otherwise noted)

Symbol	Parameter	Test Condition	Min	Typ	Max	Unit	
<b>OFF CHARACTERISTICS</b>							
$V_{(BR)GSS}$	Gate-Source Breakdown Voltage	$I_G = -1.0 \mu\text{A}, V_{DS} = 0$	-25	-	-	V	
$I_{GSS}$	Gate Reverse Current	$V_{GS} = -20 \text{ V}, V_{DS} = 0$ $V_{GS} = -20 \text{ V}, V_{DS} = 0, T_A = 100^\circ\text{C}$	-	-	-1.0 -0.2	nA $\mu\text{A}$	
$V_{GS(off)}$	Gate-Source Cutoff Voltage	$V_{DS} = 15 \text{ V}, I_D = 10 \text{ nA}$	5484 5485 5486	-0.3 -0.5 -2.0	-	-3.0 -4.0 -6.0	V V V

## ON CHARACTERISTICS

$I_{DSS}$	Zero-Gate Voltage Drain Current*	$V_{DS} = 15 \text{ V}, V_{GS} = 0$	5484 5485 5486	1.0 4.0 8.0	- - -	5.0 10 20	mA mA mA
-----------	----------------------------------	-------------------------------------	----------------------	-------------------	-------------	-----------------	----------------

## SMALL SIGNAL CHARACTERISTICS

$g_{fs}$	Forward Transfer Conductance	$V_{DS} = 15 \text{ V}, V_{GS} = 0, f = 1.0 \text{ kHz}$	5484 5485 5486	3000 3500 4000	- - -	6000 7000 8000	$\mu\text{mhos}$ $\mu\text{mhos}$ $\mu\text{mhos}$		
$Re(y_{is})$	Input Conductance	$V_{DS} = 15 \text{ V}, V_{GS} = 0, f = 100 \text{ MHz}$	5484	-	-	100	$\mu\text{mhos}$		
		$V_{DS} = 15 \text{ V}, V_{GS} = 0, f = 400 \text{ kHz}$	5485 / 5486	-	-	1000	$\mu\text{mhos}$		
$g_{os}$	Output Conductance	$V_{DS} = 15 \text{ V}, V_{GS} = 0, f = 1.0 \text{ kHz}$	5484 5485 5486	- - -	- - -	50 60 75	$\mu\text{mhos}$ $\mu\text{mhos}$ $\mu\text{mhos}$		
		$Re(y_{os})$	Output Conductance	$V_{DS} = 15 \text{ V}, V_{GS} = 0, f = 100 \text{ MHz}$	5484	-	-	75	$\mu\text{mhos}$
				$V_{DS} = 15 \text{ V}, V_{GS} = 0, f = 400 \text{ MHz}$	5485 / 5486	-	-	100	$\mu\text{mhos}$
$Re(y_{fs})$	Forward Transconductance	$V_{DS} = 15 \text{ V}, V_{GS} = 0, f = 100 \text{ MHz}$	5484	2500	-	-	$\mu\text{mhos}$		
		$V_{DS} = 15 \text{ V}, V_{GS} = 0, f = 400 \text{ MHz}$	5485	3000	-	-	$\mu\text{mhos}$		
			5486	3500	-	-	$\mu\text{mhos}$		
$C_{iss}$	Input Capacitance	$V_{DS} = 15 \text{ V}, V_{GS} = 0, f = 1.0 \text{ MHz}$	-	-	-	5.0	pF		
$C_{rss}$	Reverse Transfer Capacitance	$V_{DS} = 15 \text{ V}, V_{GS} = 0, f = 1.0 \text{ MHz}$	-	-	-	1.0	pF		
$C_{oss}$	Output Capacitance	$V_{DS} = 15 \text{ V}, V_{GS} = 0, f = 1.0 \text{ MHz}$	-	-	-	2.0	pF		
NF	Noise Figure	$V_{DS} = 15 \text{ V}, R_G = 1.0 \text{ k}\Omega, f = 100 \text{ MHz}$	5484	-	-	3.0	dB		
		$V_{DS} = 15 \text{ V}, R_G = 1.0 \text{ k}\Omega, f = 400 \text{ MHz}$	5484	-	4.0	-	dB		
		$V_{DS} = 15 \text{ V}, R_G = 1.0 \text{ k}\Omega, f = 100 \text{ MHz}$	5485 / 5486	-	-	2.0	dB		
		$V_{DS} = 15 \text{ V}, R_G = 1.0 \text{ k}\Omega, f = 400 \text{ MHz}$	5485 / 5486	-	-	4.0	dB		

Product parametric performance is indicated in the Electrical Characteristics for the listed test conditions, unless otherwise noted. Product performance may not be indicated by the Electrical Characteristics if operated under different conditions.

TYPICAL CHARACTERISTICS

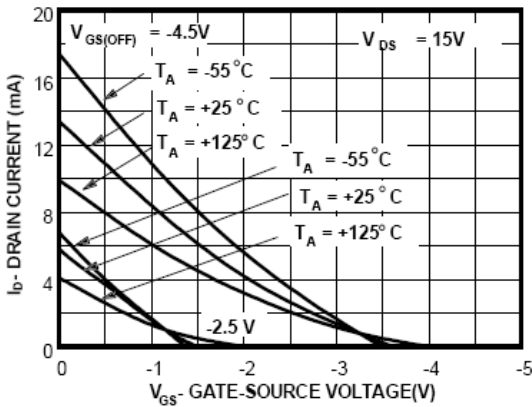

Figure 1. Transfer Characteristics

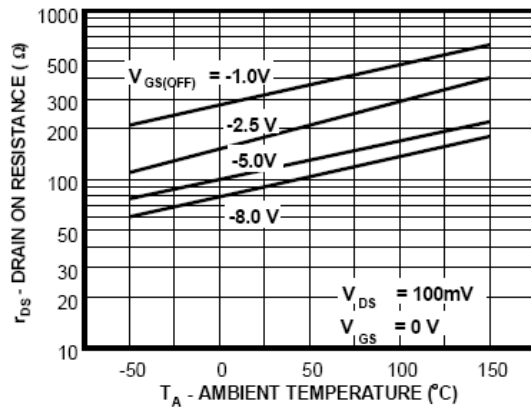

Figure 2. Channel Resistance vs. Temperature

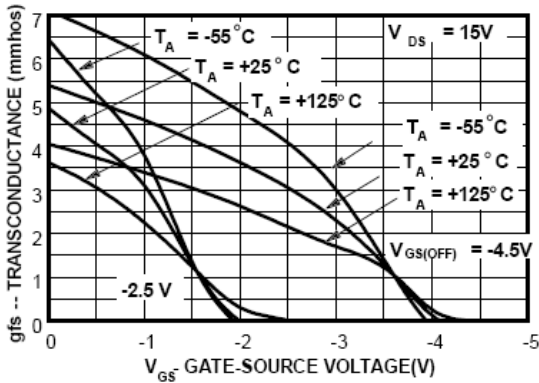

Figure 3. Transconductance Characteristics

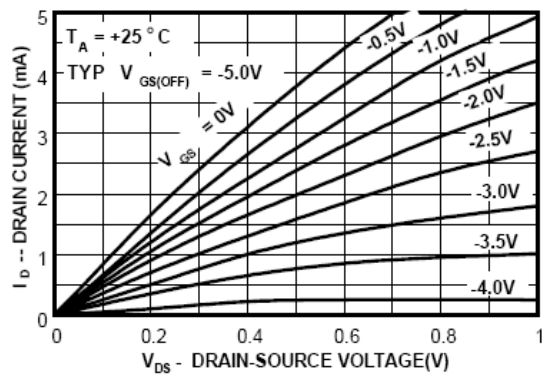

Figure 4. Common Drain-Source Characteristics

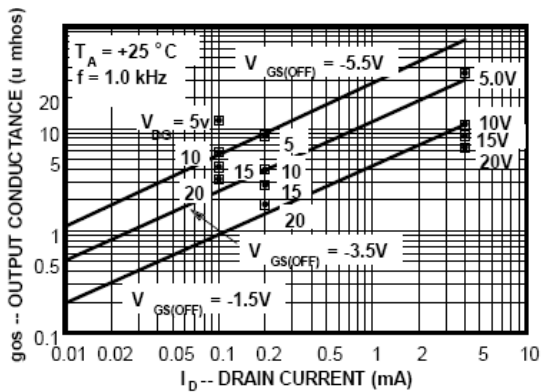

Figure 5. Output Conductance vs. Drain Current

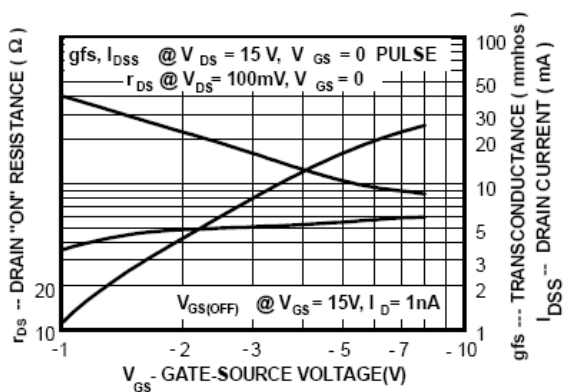

Figure 6. Transconductance Parameter Interactions

# MMBF5484, MMBF5485, MMBF5486

## TYPICAL CHARACTERISTICS (continued)

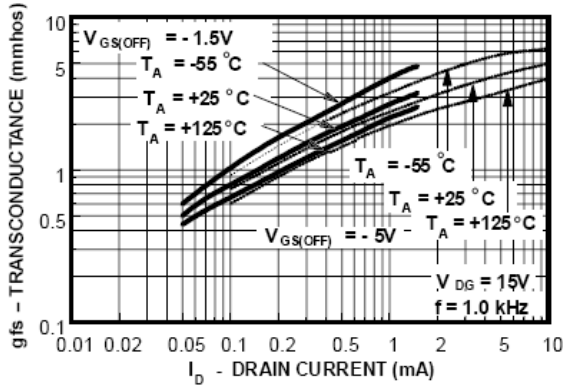

Figure 7. Transconductance vs. Drain Current

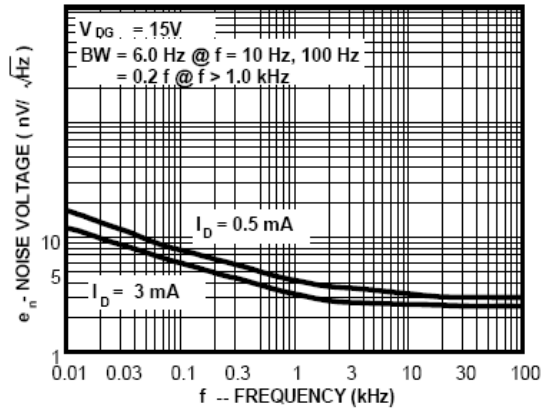

Figure 8. Noise Voltage vs. Frequency

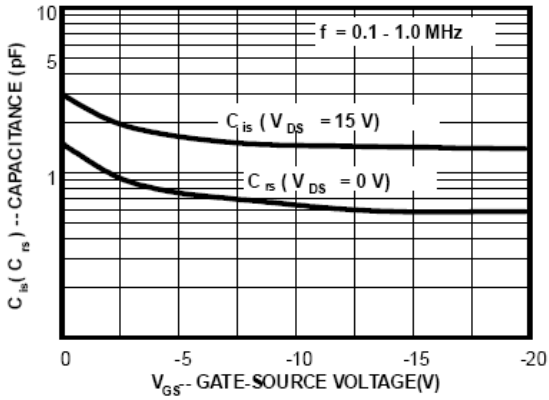

Figure 9. Capacitance vs. Voltage

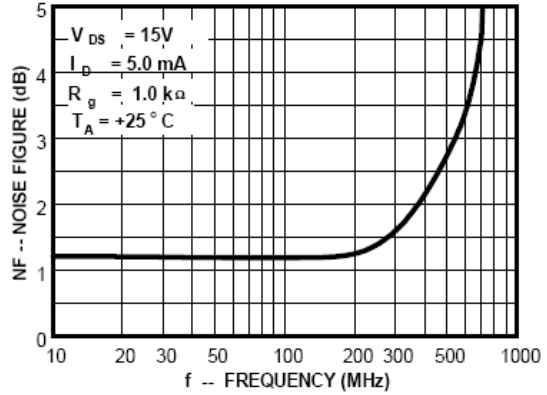

Figure 10. Noise Figure Frequency

COMMON SOURCE CHARACTERISTICS

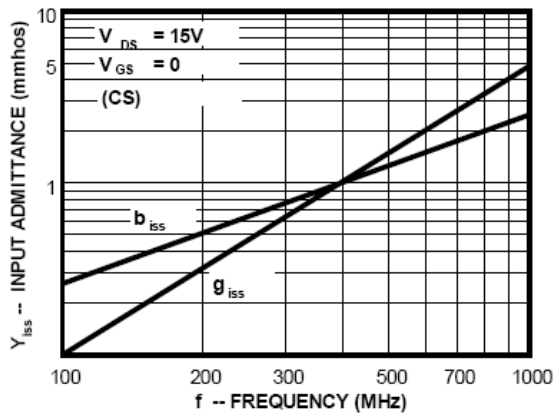

Figure 11. Input Admittance

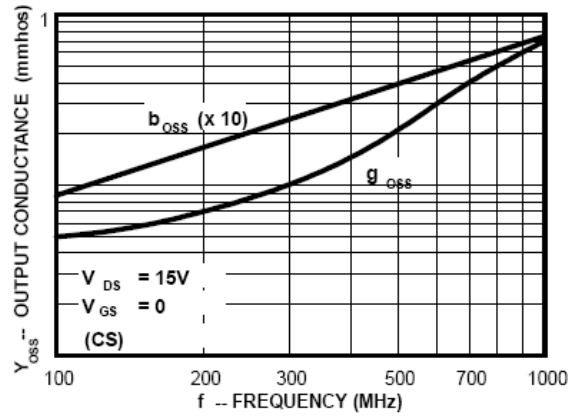

Figure 12. Output Admittance

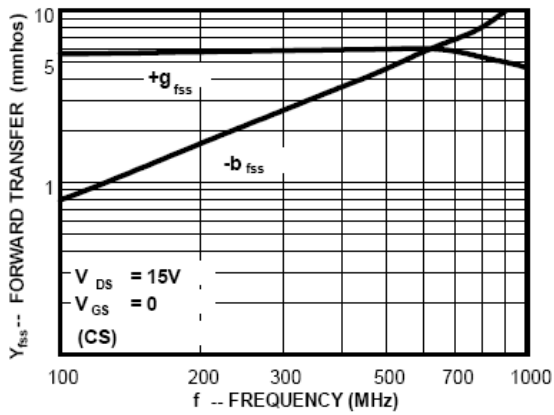

Figure 13. Forward Transadmittance

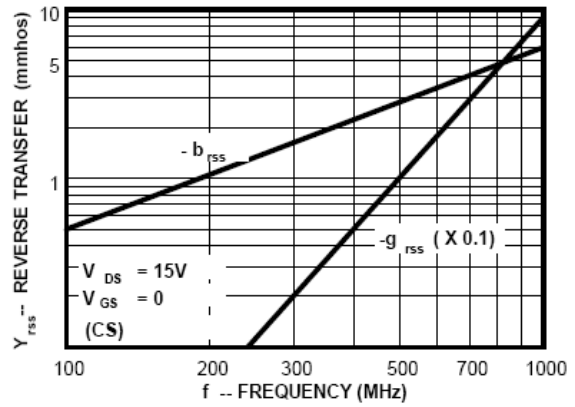

Figure 14. Reverse Transadmittance

COMMON GATE CHARACTERISTICS

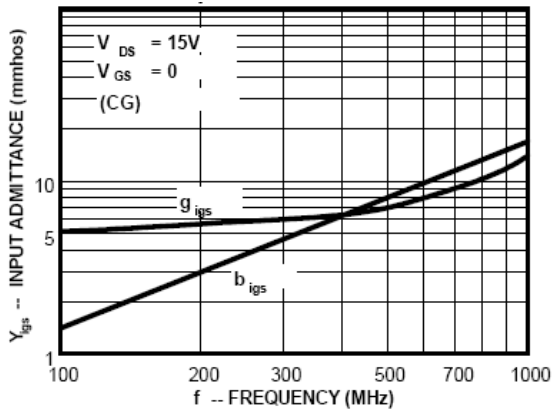

Figure 15. Input Admittance

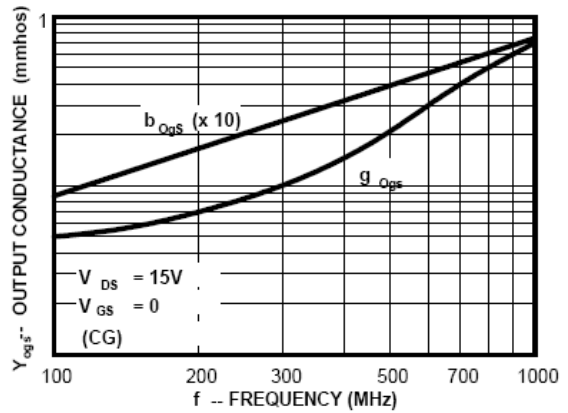

Figure 16. Output Admittance

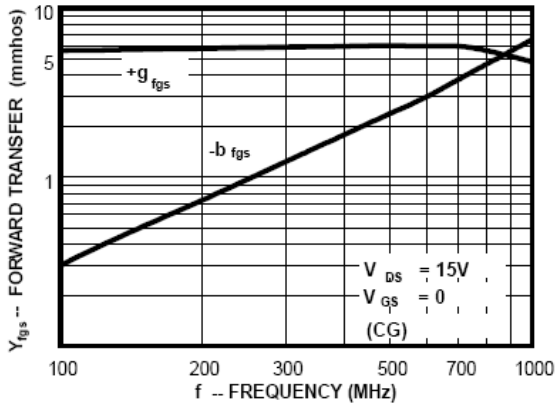

Figure 17. Forward Transadmittance

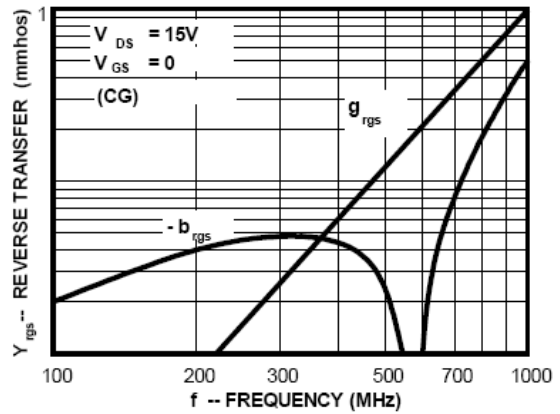

Figure 18. Reverse Transadmittance

# MECHANICAL CASE OUTLINE

## PACKAGE DIMENSIONS

ON Semiconductor®



**SOT-23 (TO-236)**  
CASE 318-08  
ISSUE AS

DATE 30 JAN 2018

SCALE 4:1

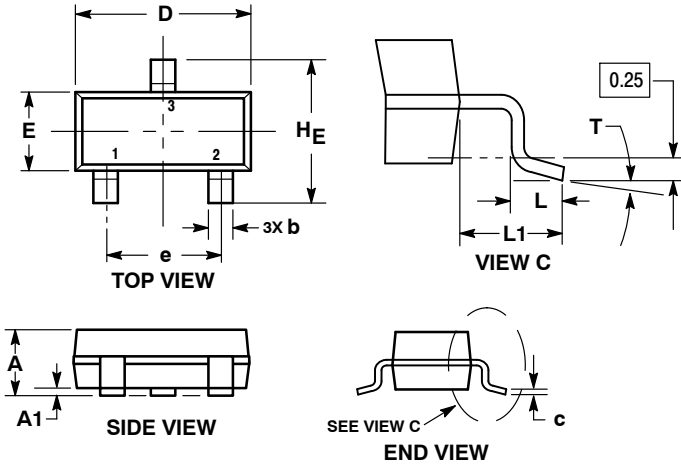

**NOTES:**

1. DIMENSIONING AND TOLERANCING PER ASME Y14.5M, 1994.
2. CONTROLLING DIMENSION: MILLIMETERS.
3. MAXIMUM LEAD THICKNESS INCLUDES LEAD FINISH. MINIMUM LEAD THICKNESS IS THE MINIMUM THICKNESS OF THE BASE MATERIAL.
4. DIMENSIONS D AND E DO NOT INCLUDE MOLD FLASH, PROTRUSIONS, OR GATE BURRS.

DIM	MILLIMETERS			INCHES		
	MIN	NOM	MAX	MIN	NOM	MAX
A	0.89	1.00	1.11	0.035	0.039	0.044
A1	0.01	0.06	0.10	0.000	0.002	0.004
b	0.37	0.44	0.50	0.015	0.017	0.020
c	0.08	0.14	0.20	0.003	0.006	0.008
D	2.80	2.90	3.04	0.110	0.114	0.120
E	1.20	1.30	1.40	0.047	0.051	0.055
e	1.78	1.90	2.04	0.070	0.075	0.080
L	0.30	0.43	0.55	0.012	0.017	0.022
L1	0.35	0.54	0.69	0.014	0.021	0.027
HE	2.10	2.40	2.64	0.083	0.094	0.104
T	0°	---	10°	0°	---	10°

**RECOMMENDED SOLDERING FOOTPRINT**

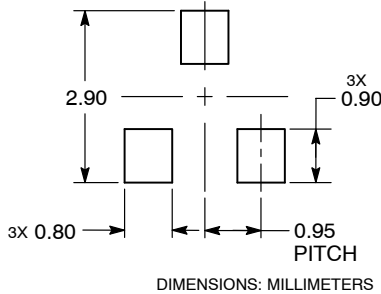

**GENERIC MARKING DIAGRAM\***



XXX = Specific Device Code  
M = Date Code  
▪ = Pb-Free Package

\*This information is generic. Please refer to device data sheet for actual part marking. Pb-Free indicator, "G" or microdot "▪", may or may not be present.

STYLE 1 THRU 5:  
CANCELLED

STYLE 6:  
PIN 1. BASE  
2. EMITTER  
3. COLLECTOR

STYLE 7:  
PIN 1. EMITTER  
2. BASE  
3. COLLECTOR

STYLE 8:  
PIN 1. ANODE  
2. NO CONNECTION  
3. CATHODE

STYLE 9:  
PIN 1. ANODE  
2. ANODE  
3. CATHODE

STYLE 10:  
PIN 1. DRAIN  
2. SOURCE  
3. GATE

STYLE 11:  
PIN 1. ANODE  
2. CATHODE  
3. CATHODE-ANODE

STYLE 12:  
PIN 1. CATHODE  
2. CATHODE  
3. ANODE

STYLE 13:  
PIN 1. SOURCE  
2. DRAIN  
3. GATE

STYLE 14:  
PIN 1. CATHODE  
2. GATE  
3. ANODE

STYLE 15:  
PIN 1. GATE  
2. CATHODE  
3. ANODE

STYLE 16:  
PIN 1. ANODE  
2. CATHODE  
3. CATHODE

STYLE 17:  
PIN 1. NO CONNECTION  
2. ANODE  
3. CATHODE

STYLE 18:  
PIN 1. NO CONNECTION  
2. CATHODE  
3. ANODE

STYLE 19:  
PIN 1. CATHODE  
2. ANODE  
3. CATHODE-ANODE

STYLE 20:  
PIN 1. CATHODE  
2. ANODE  
3. GATE

STYLE 21:  
PIN 1. GATE  
2. SOURCE  
3. DRAIN

STYLE 22:  
PIN 1. RETURN  
2. OUTPUT  
3. INPUT

STYLE 23:  
PIN 1. ANODE  
2. ANODE  
3. CATHODE

STYLE 24:  
PIN 1. GATE  
2. DRAIN  
3. SOURCE

STYLE 25:  
PIN 1. ANODE  
2. CATHODE  
3. GATE

STYLE 26:  
PIN 1. CATHODE  
2. ANODE  
3. NO CONNECTION

STYLE 27:  
PIN 1. CATHODE  
2. CATHODE  
3. CATHODE

STYLE 28:  
PIN 1. ANODE  
2. ANODE  
3. ANODE

<b>DOCUMENT NUMBER:</b>	<b>98ASB42226B</b>	Electronic versions are uncontrolled except when accessed directly from the Document Repository. Printed versions are uncontrolled except when stamped "CONTROLLED COPY" in red.
<b>DESCRIPTION:</b>	<b>SOT-23 (TO-236)</b>	<b>PAGE 1 OF 1</b>

ON Semiconductor and ON are trademarks of Semiconductor Components Industries, LLC dba ON Semiconductor or its subsidiaries in the United States and/or other countries. ON Semiconductor reserves the right to make changes without further notice to any products herein. ON Semiconductor makes no warranty, representation or guarantee regarding the suitability of its products for any particular purpose, nor does ON Semiconductor assume any liability arising out of the application or use of any product or circuit, and specifically disclaims any and all liability, including without limitation special, consequential or incidental damages. ON Semiconductor does not convey any license under its patent rights nor the rights of others.

**onsemi**, **Onsemi**, and other names, marks, and brands are registered and/or common law trademarks of Semiconductor Components Industries, LLC dba "**onsemi**" or its affiliates and/or subsidiaries in the United States and/or other countries. **onsemi** owns the rights to a number of patents, trademarks, copyrights, trade secrets, and other intellectual property. A listing of **onsemi**'s product/patent coverage may be accessed at [www.onsemi.com/site/pdf/Patent-Marking.pdf](http://www.onsemi.com/site/pdf/Patent-Marking.pdf). **onsemi** reserves the right to make changes at any time to any products or information herein, without notice. The information herein is provided "as-is" and **onsemi** makes no warranty, representation or guarantee regarding the accuracy of the information, product features, availability, functionality, or suitability of its products for any particular purpose, nor does **onsemi** assume any liability arising out of the application or use of any product or circuit, and specifically disclaims any and all liability, including without limitation special, consequential or incidental damages. Buyer is responsible for its products and applications using **onsemi** products, including compliance with all laws, regulations and safety requirements or standards, regardless of any support or applications information provided by **onsemi**. "Typical" parameters which may be provided in **onsemi** data sheets and/or specifications can and do vary in different applications and actual performance may vary over time. All operating parameters, including "Typicals" must be validated for each customer application by customer's technical experts. **onsemi** does not convey any license under any of its intellectual property rights nor the rights of others. **onsemi** products are not designed, intended, or authorized for use as a critical component in life support systems or any FDA Class 3 medical devices or medical devices with a same or similar classification in a foreign jurisdiction or any devices intended for implantation in the human body. Should Buyer purchase or use **onsemi** products for any such unintended or unauthorized application, Buyer shall indemnify and hold **onsemi** and its officers, employees, subsidiaries, affiliates, and distributors harmless against all claims, costs, damages, and expenses, and reasonable attorney fees arising out of, directly or indirectly, any claim of personal injury or death associated with such unintended or unauthorized use, even if such claim alleges that **onsemi** was negligent regarding the design or manufacture of the part. **onsemi** is an Equal Opportunity/Affirmative Action Employer. This literature is subject to all applicable copyright laws and is not for resale in any manner.

## PUBLICATION ORDERING INFORMATION

### LITERATURE FULFILLMENT:

Email Requests to: [orderlit@onsemi.com](mailto:orderlit@onsemi.com)

**onsemi Website:** [www.onsemi.com](http://www.onsemi.com)

### TECHNICAL SUPPORT

**North American Technical Support:**

Voice Mail: 1 800-282-9855 Toll Free USA/Canada

Phone: 011 421 33 790 2910

**Europe, Middle East and Africa Technical Support:**

Phone: 00421 33 790 2910

For additional information, please contact your local Sales Representative