



CA3078

March 1993

Micropower Operational Amplifier

Features

- Low Standby Power..... As Low As 700nW
- Wide Supply Voltage Range..... $\pm 0.75V$ to $\pm 15V$
- High Peak Output Current..... 6.5mA min.
- Adjustable Quiescent Current
- Output Short Circuit Protection

Applications

- Portable Electronics
- Medical Electronics
- Instrumentation
- Telemetry
- Intrusion Alarms

Ordering Information

PART NUMBER	TEMPERATURE RANGE	PACKAGE
CA3078AE	-55°C to +125°C	8 Lead Plastic DIP
CA3078AM	-55°C to +125°C	8 Lead SOIC
CA3078AM96	-55°C to +125°C	8 Lead SOIC*
CA3078AT	-55°C to +125°C	8 Pin Can
CA3078E	0°C to +70°C	8 Lead Plastic DIP
CA3078M	0°C to +70°C	8 Lead SOIC
CA3078M96	0°C to +70°C	8 Lead SOIC*
CA3078T	0°C to +70°C	8 Pin Can

* Denotes Tape and Reel

Description

The CA3078 and CA3078A are high gain monolithic operational amplifiers which can deliver milliamperes of current yet only consume microwatts of standby power. Their operating points are externally adjustable and frequency compensation may be accomplished with one external capacitor. The CA3078 and CA3078A provide the designer with the opportunity to tailor the frequency response and improve the slew rate without sacrificing power. Operation with a single 1.5V battery is a practical reality with these devices.

The CA3078A is a premium device having a supply voltage range of $V_{\pm} = 0.75V$ to $V_{\pm} = 15V$. The CA3078 has the same lower supply voltage limit but the upper limit is $V_{+} = +6V$ and $V_{-} = -6V$.

Pinouts

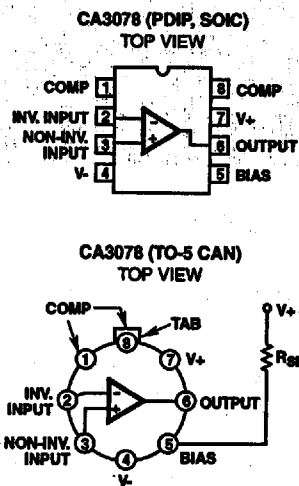

NOTE: Pin 4 is connected to case.

Schematic Diagram

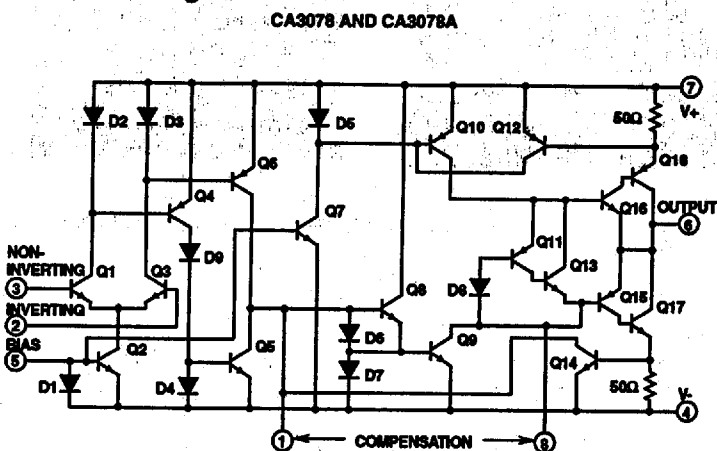

Specifications CA3078, CA3078A

Absolute Maximum Ratings $T_A = +25^\circ\text{C}$

Supply Voltage (Between V+ and V- Terminal)

CA3078 14V

CA3078A 36V

Differential Input Voltage 6V

Input Voltage V+ to V-

Input Current 0.1mA

Output Short Circuit Duration (Note 1) No Limitation

Junction Temperature $+175^\circ\text{C}$

Junction Temperature (Plastic Package) $+150^\circ\text{C}$

Lead Temperature (Soldering 10 Sec.) $+300^\circ\text{C}$

Operating Conditions

Operating Temperature Range

CA3078 0°C to $+70^\circ\text{C}$

CA3078A -55°C to $+125^\circ\text{C}$

Storage Temperature Range -65°C to $+150^\circ\text{C}$

CAUTION: Stresses above those listed in "Absolute Maximum Ratings" may cause permanent damage to the device. This is a stress only rating and operation of the device at these or any other conditions above those indicated in the operational sections of this specification is not implied.

Electrical Specifications For Equipment Design

SYMBOL	TEST CONDITIONS			CA3078A LIMITS					CA3078 LIMITS					UNITS
				$R_{SET} = 5.1\text{M}\Omega$					$R_{SET} = 1\text{M}\Omega$					
	V+ and V-	R_S (k Ω)	R_L (k Ω)	$T_A = +25^\circ\text{C}$			$T_A = -55^\circ\text{C}$ to $+125^\circ\text{C}$		$T_A = +25^\circ\text{C}$			$T_A = 0^\circ\text{C}$ to $+70^\circ\text{C}$		
				MIN	TYP	MAX	MIN	MAX	MIN	TYP	MAX	MIN	MAX	
V_{IO}	$\pm 6\text{V}$	≤ 10	-	-	0.70	3.5	-	4.5	-	1.3	4.5	-	5	mV
I_{IO}		-	-	-	0.50	2.5	-	5.0	-	6	32	-	40	nA
I_{IB}		-	-	-	7	12	-	50	-	60	170	-	200	nA
A_{OL}		-	≥ 10	92	100	-	90	-	88	92	-	86	-	dB
I_Q		-	-	-	20	25	-	45	-	100	130	-	150	μA
P_D		-	-	-	240	300	-	540	-	1200	1560	-	1800	μW
V_{OM}		-	≥ 10	± 5.1	± 5.3	-	± 5	-	± 5.1	± 5.3	-	± 5	-	V
V_{ICR}		≤ 10	-	-	-5.5 to +5.8	-	-5 to +5	-	-	-5.5 to +5.8	-	-5 to +5	-	V
CMRR		≤ 10	-	80	115	-	-	-	80	110	-	-	-	dB
I_{OM+} or I_{OM-}		-	-	-	12	-	6.5	30	-	12	-	6.5	30	mA
$\Delta V_{IO}/\Delta V+$		≤ 10	-	76	105	-	-	-	76	93	-	-	-	$\mu\text{V/V}$
$\Delta V_{IO}/\Delta V-$		≤ 10	-	76	105	-	-	-	76	93	-	-	-	$\mu\text{V/V}$
$R_{SET} = 13\text{M}\Omega$														
V_{IO}	$\pm 15\text{V}$	≤ 10	-	-	1.4	3.5	-	4.5	-	-	-	-	-	mV
A_{OL}		-	≥ 10	92	100	-	88	-	-	-	-	-	-	dB
I_Q		-	-	-	20	30	-	50	-	-	-	-	-	μA
P_D		-	-	-	600	750	-	1350	-	-	-	-	-	μW
V_{OM}		-	≥ 10	± 13.7	± 14.1	-	± 13.5	-	-	-	-	-	-	V
CMRR		≤ 10	-	80	106	-	-	-	-	-	-	-	-	dB
I_{IB}		-	-	-	7	14	-	55	-	-	-	-	-	nA
I_{IO}		-	-	-	0.50	2.7	-	5.5	-	-	-	-	-	nA

NOTE:

- Short circuit may be applied to ground or to either supply.

2
OPERATIONAL AMPLIFIERS

Specifications CA3078, CA3078A

Electrical Specifications $T_A = +25^\circ\text{C}$, Typical Values Intended Only for Design Guidance

SYMBOL	TYPICAL VALUES				UNITS
	CA3078A		CA3078		
	$V_+ = +1.3\text{V}$, $V_- = -1.3\text{V}$ $R_{SET} = 2\text{M}\Omega$	$V_+ = +0.75\text{V}$, $V_- = -0.75\text{V}$ $R_{SET} = 10\text{M}\Omega$	$V_+ = +1.3\text{V}$, $V_- = -1.3\text{V}$ $R_{SET} = 2\text{M}\Omega$	$V_+ = +0.75\text{V}$, $V_- = -0.75\text{V}$ $R_{SET} = 10\text{M}\Omega$	
V_{IO}	0.7	0.9	1.3	1.5	mV
I_{IO}	0.3	0.054	1.7	0.5	nA
I_{IB}	3.7	0.45	9	1.3	nA
A_{OL}	84	65	80	60	dB
I_Q	10	1	10	1	μA
P_D	26	1.5	26	1.5	μW
V_{OPP}	1.4	0.3	1.4	0.3	V
V_{ICR}	-0.8 to +1.1	-0.2 to +0.5	-0.8 to +1.1	-0.2 to +0.5	V
CMRR	100	90	100	90	dB
$I_{OM\pm}$	12	0.5	12	0.5	mA
$\Delta V_{IO}/\Delta V_{\pm}$	20	50	20	50	$\mu\text{V/V}$

Electrical Specifications $T_A = +25^\circ\text{C}$ and $V_+ = +6\text{V}$, $V_- = -6\text{V}$, Typical Values Intended Only for Design Guidance

SYMBOL	TEST CONDITIONS	CA3078A		CA3078	UNITS
		$R_{SET} = 5.1\text{M}\Omega$	$R_{SET} = 1\text{M}\Omega$	$R_{SET} = 1\text{M}\Omega$	
$\Delta V_{IO}/\Delta T_A$	$R_S \leq 10\text{k}\Omega$	5	6	6	$\mu\text{V}/^\circ\text{C}$
$\Delta I_{IO}/\Delta T_A$	$R_S \leq 10\text{k}\Omega$	6.3	70	70	$\text{pA}/^\circ\text{C}$
BW_{OL}	3dB pt	0.3	2	2	kHz
SR	See Figures 18, 19	0.027	0.04	0.04	V/ μs
		0.5	1.5	1.5	V/ μs
t_R	10% to 90% Rise Time	3	2.5	2.5	μs
R_{II}	-	7.4	1.7	0.87	M Ω
R_O	-	1	0.8	0.8	k Ω
$e_N(10\text{Hz})$	$R_S = 0$	40	-	25	$\text{nV}/\sqrt{\text{Hz}}$
$i_N(10\text{Hz})$	$R_S = 1\text{M}\Omega$	0.25	-	1	$\text{pA}/\sqrt{\text{Hz}}$

Typical Performance Curves

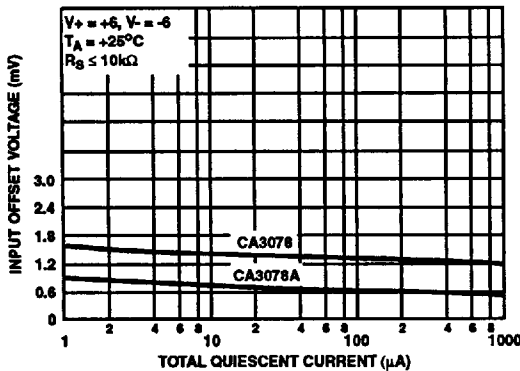

FIGURE 1. INPUT OFFSET VOLTAGE vs TOTAL QUIESCENT CURRENT

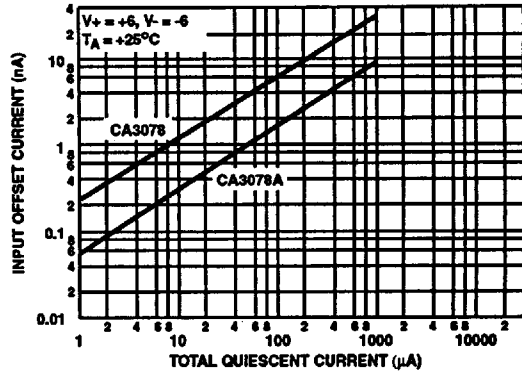

FIGURE 2. INPUT OFFSET CURRENT vs TOTAL QUIESCENT CURRENT

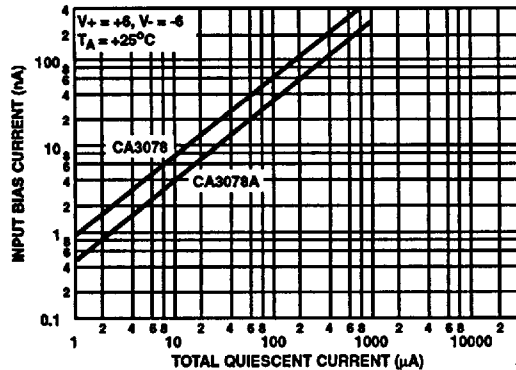

FIGURE 3. INPUT BIAS CURRENT vs TOTAL QUIESCENT CURRENT

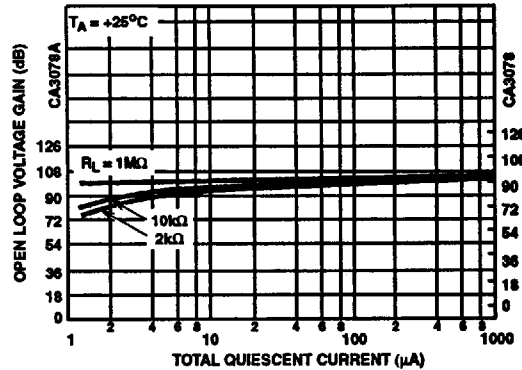

FIGURE 4. OPEN LOOP VOLTAGE GAIN vs TOTAL QUIESCENT CURRENT

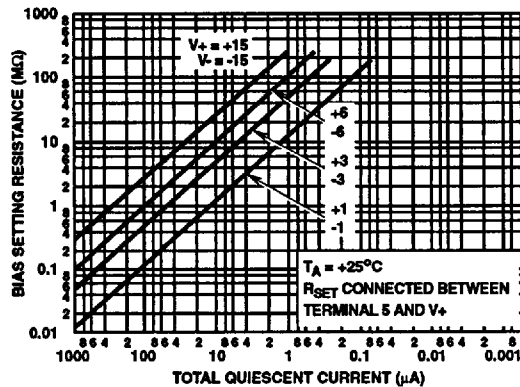

FIGURE 5. BIAS SETTING RESISTANCE vs TOTAL QUIESCENT CURRENT

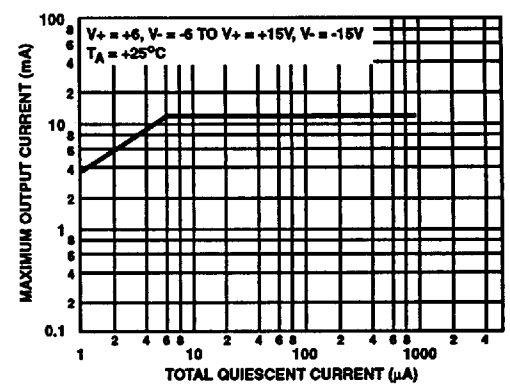

FIGURE 6. MAXIMUM OUTPUT CURRENT vs TOTAL QUIESCENT CURRENT

2
OPERATIONAL AMPLIFIERS

Typical Performance Curves (Continued)

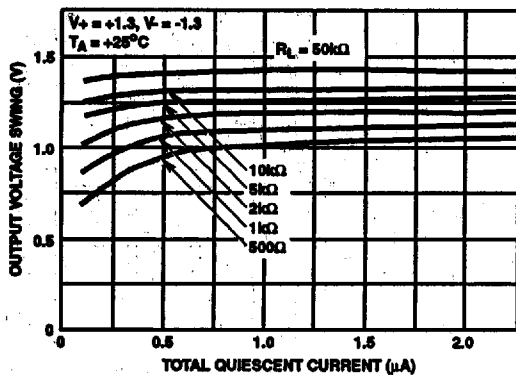

FIGURE 7. OUTPUT VOLTAGE SWING vs TOTAL QUIESCENT CURRENT

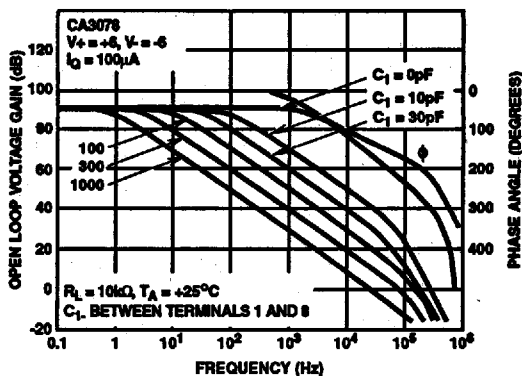

FIGURE 8. OPEN LOOP VOLTAGE GAIN vs FREQUENCY FOR CA3078

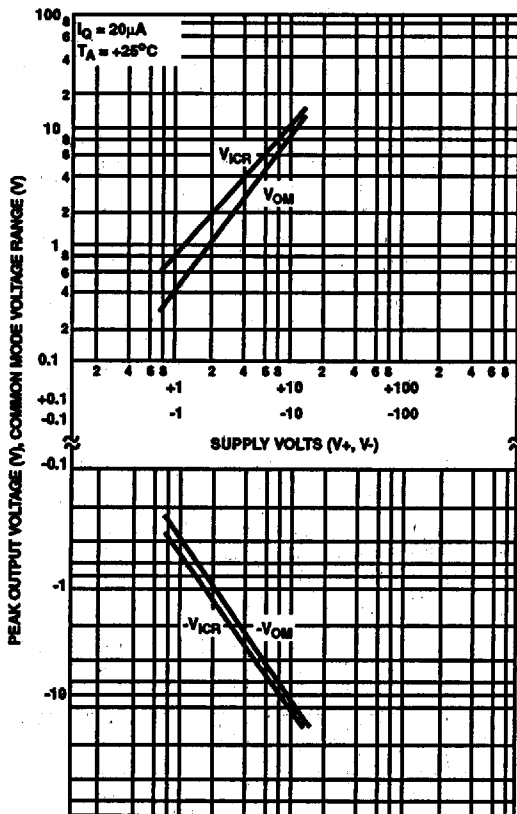

FIGURE 9. OUTPUT AND COMMON MODE VOLTAGE vs SUPPLY VOLTAGE

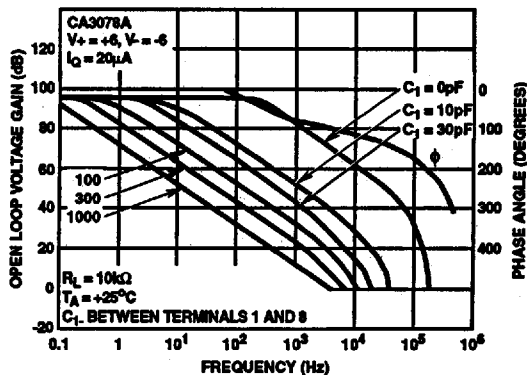

FIGURE 10. OPEN LOOP VOLTAGE GAIN vs FREQUENCY FOR CA3078A

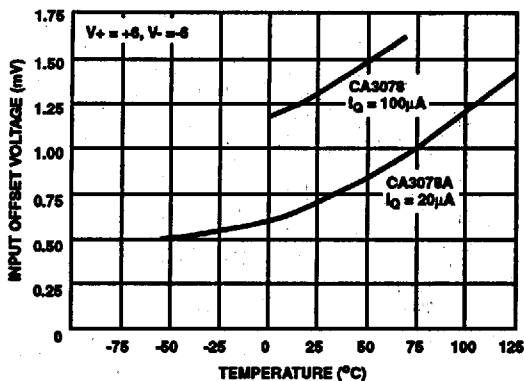

FIGURE 11. INPUT OFFSET VOLTAGE vs TEMPERATURE

Typical Performance Curves (Continued)

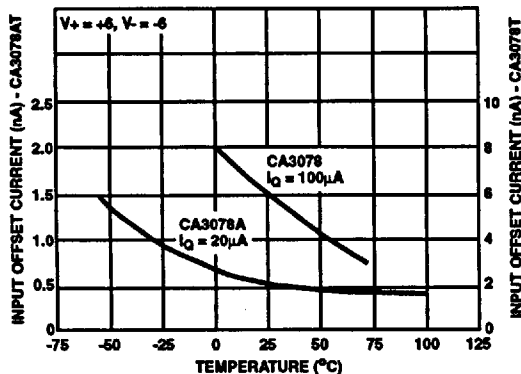

FIGURE 12. INPUT OFFSET CURRENT vs TEMPERATURE

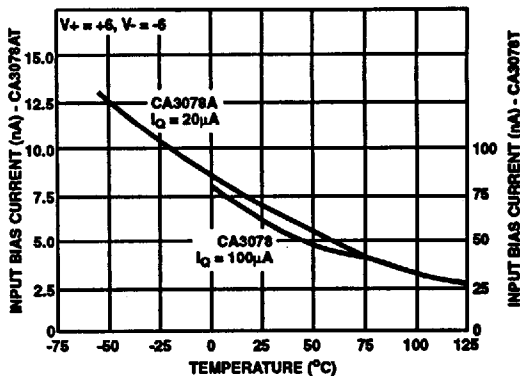

FIGURE 13. INPUT BIAS CURRENT vs TEMPERATURE

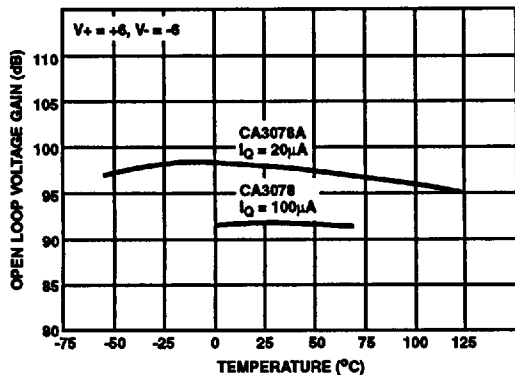

FIGURE 14. OPEN LOOP VOLTAGE GAIN vs TEMPERATURE

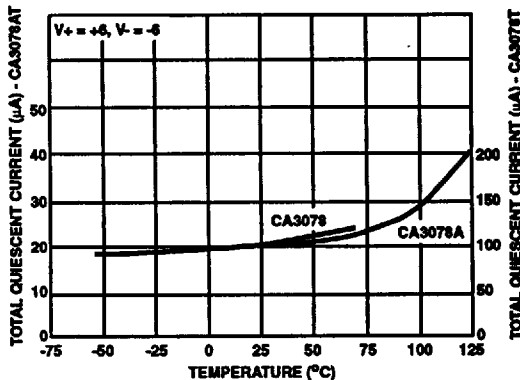

FIGURE 15. TOTAL QUIESCENT CURRENT vs TEMPERATURE

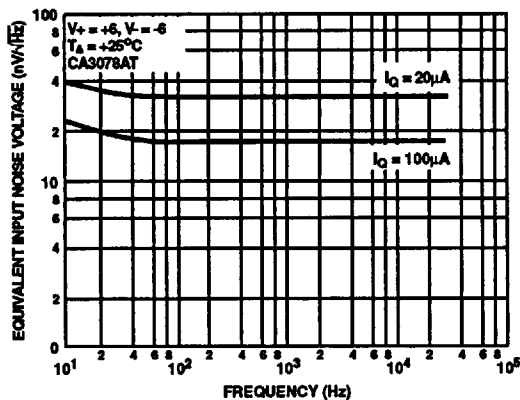

FIGURE 16. EQUIVALENT INPUT NOISE VOLTAGE vs FREQUENCY

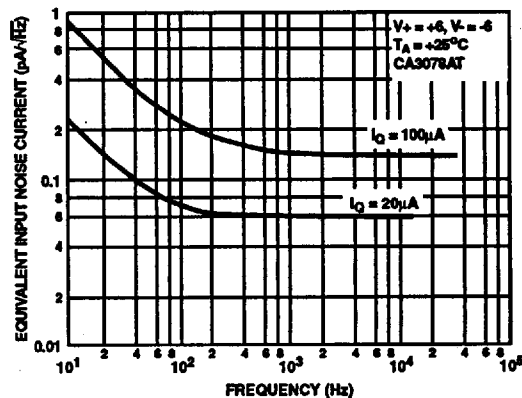
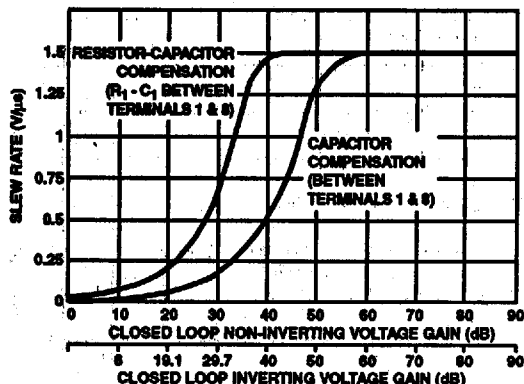

FIGURE 17. EQUIVALENT INPUT NOISE CURRENT vs FREQUENCY

2
OPERATIONAL
AMPLIFIERS

Typical Performance Curves (Continued)



Supply Volts: $V_+ = +6, V_- = -6$
 Quiescent Current (I_Q) = 100µA
 Ambient Temperature (T_A) = +25°C
 Load Impedance: $R_L = 10k\Omega, C_L = 100pF$
 Feedback Resistance (R_F) = 0.1MΩ
 Output Voltage (V_{OPP}) = 10V
 R_1 determined for transient response with 10% overshoot on a 100mV output signal ($R_1 \times C_1 = 2.5 \times 10^{-9}$)

FIGURE 18. SLEW RATE vs CLOSED LOOP GAIN FOR $I_Q = 100\mu A$ - CA3078

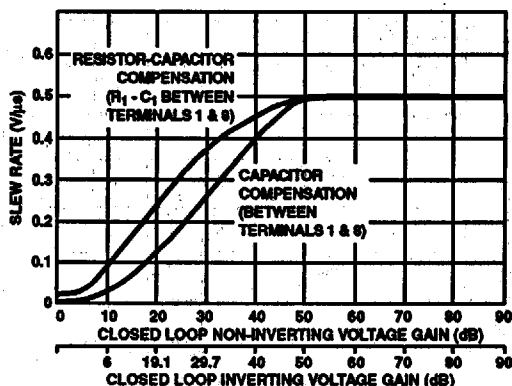

Supply Volts: $V_+ = +6, V_- = -6$
 Quiescent Current (I_Q) = 20µA
 Ambient Temperature (T_A) = +25°C
 Load Impedance: $R_L = 10k\Omega, C_L = 100pF$
 Feedback Resistance (R_F) = 0.1MΩ
 Output Voltage (V_{OPP}) = 10V
 R_1 determined for transient response with 10% overshoot on a 100mV output signal ($R_1 \times C_1 = 2 \times 10^{-9}$)

FIGURE 19. SLEW RATE vs CLOSED LOOP GAIN FOR $I_Q = 20\mu A$ - CA3078A

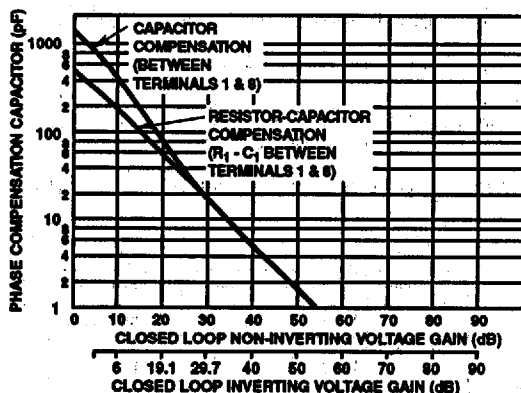

Supply Volts: $V_+ = +6, V_- = -6$
 Quiescent Current (I_Q) = 100µA
 Ambient Temperature (T_A) = +25°C
 Load Impedance: $R_L = 10k\Omega, C_L = 100pF$
 Feedback Resistance (R_F) = 0.1MΩ
 Output Voltage (V_{OPP}) = 100mV
 R_1 determined for transient response with 10% overshoot on a 100mV output signal ($R_1 \times C_1 = 2.5 \times 10^{-9}$)

FIGURE 20. PHASE COMPENSATION CAPACITANCE vs CLOSED LOOP GAIN - CA3078

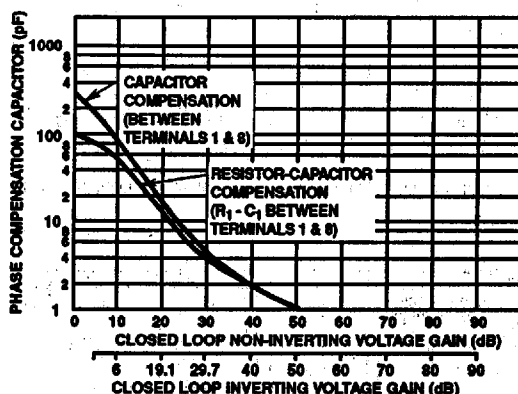

Supply Volts: $V_+ = +6, V_- = -6$
 Quiescent Current (I_Q) = 20µA
 Ambient Temperature (T_A) = +25°C
 Load Impedance: $R_L = 10k\Omega, C_L = 100pF$
 Feedback Resistance (R_F) = 0.1MΩ
 Output Voltage (V_{OPP}) = 100mV
 R_1 determined for transient response with 10% overshoot on a 100mV output signal ($R_1 \times C_1 = 2 \times 10^{-9}$)

FIGURE 21. PHASE COMPENSATION CAPACITANCE vs CLOSED LOOP GAIN - CA3078A

TABLE 1. UNITY GAIN SLEW RATE vs COMPENSATION - CA3078 AND CA3078A

Supply Volts: $V_+ = +6$, $V_- = -6$, Output Voltage (V_O) = $\pm 5V$, Load Resistance (R_L) = $10k\Omega$, Transient Response: 10% overshoot for an output voltage of 100mV, Ambient Temperature (T_A) = $+25^\circ C$

COMPENSATION TECHNIQUE	UNITY GAIN (INVERTING) FIGURE 22					UNITY GAIN (NON-INVERTING) FIGURE 23				
	R_1	C_1	R_2	C_2	SLEW RATE	R_1	C_1	R_2	C_2	SLEW RATE
	k Ω	pF	k Ω	μF	V/ μs	k Ω	pF	k Ω	μF	V/ μs
CA3078 - $I_Q = 100\mu A$										
Single Capacitor	0	750	∞	0	0.0085	0	1500	∞	0	0.0095
Resistor & Capacitor	3.5	350	∞	0	0.04	5.3	500	∞	0	0.024
Input	∞	0	0.25	0.306	0.67	∞	0	0.311	0.45	0.67
CA3078A - $I_Q = 20\mu A$										
Single Capacitor	0	300	∞	0	0.0095	0	800	∞	0	0.003
Resistor & Capacitor	14	100	∞	0	0.027	34	125	∞	0	0.02
Input	∞	0	0.644	0.156	0.29	∞	0	0.77	0.4	0.4

Operating Conditions

Compensation Techniques

The CA3078A and CA3078 can be phase compensated with one or two external components depending upon the closed loop gain, power consumption, and speed desired. The recommended compensation is a resistor in series with a capacitor connected from Terminal 1 to Terminal 8. Values of the resistor and capacitor required for compensation as a function of closed loop gain are shown in Figures 20 and 21. These curves represent the compensation necessary at quiescent currents of 100 μA and 20 μA , respectively, for a transient response with 10% overshoot. Figures 18 and 19 show the slew rates that can be obtained with the two different compensation techniques. Higher speeds can be achieved with input compensation, but this increases noise

output. Compensation can also be accomplished with a single capacitor connected from Terminal 1 to Terminal 8, with speed being sacrificed for simplicity. Table 1 gives an indication of slew rates that can be obtained with various compensation techniques at quiescent currents of 100 μA and 20 μA .

Single Supply Operation

The CA3078A and CA3078 can operate from a single supply with a minimum total supply voltage of 1.5V. Figures 25 and 26 show the CA3078A or CA3078 in inverting and non-inverting 20dB amplifier configurations utilizing a 1.5V type "AA" cell for a supply. The total consumption for either circuit is approximately 675nW. The output voltage swing in this configuration is 300mVp-p with a 20k Ω load.

2
OPERATIONAL AMPLIFIERS

Test Circuits

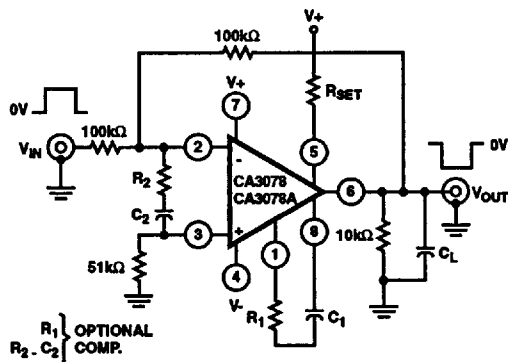

FIGURE 22. TRANSIENT RESPONSE AND SLEW RATE, UNITY GAIN (INVERTING) TEST CIRCUIT

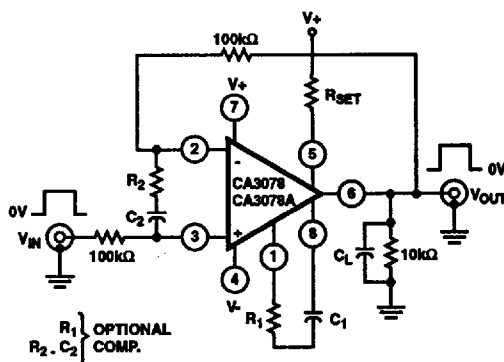
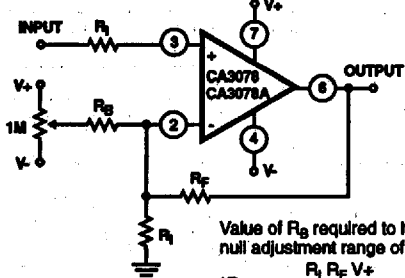

FIGURE 23. SLEW RATE, UNITY GAIN (NON-INVERTING) TEST CIRCUIT

Test Circuits (Continued)

NON-INVERTING



Value of R_B required to have a null adjustment range of $\pm 7.5\text{mV}$.

$$R_B = \frac{R_1 R_F V^+}{(R_1 + R_F) 7.5 \times 10^{-3}}$$

assuming $R_B \gg \frac{R_1 R_F}{R_1 + R_F}$

INVERTING

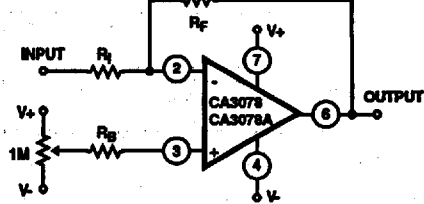

Value of R_B required to have a null adjustment range of $\pm 7.5\text{mV}$.

$$R_B = \frac{R_1 V^+}{7.5 \times 10^{-3}}$$

assuming $R_B \gg R_1$

FIGURE 24. OFFSET VOLTAGE NULL CIRCUITS

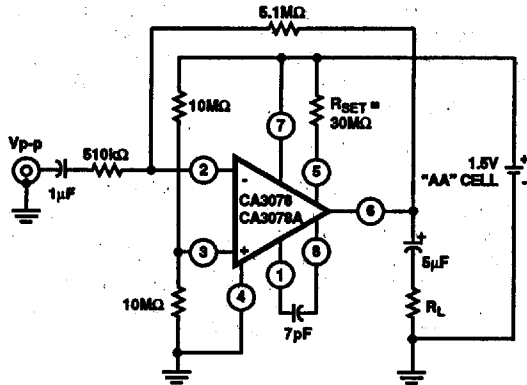

FIGURE 25. INVERTING 20dB AMPLIFIER CIRCUIT

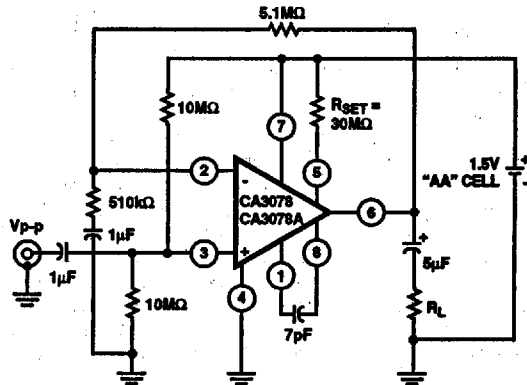

FIGURE 26. NON-INVERTING 20dB AMPLIFIER CIRCUIT