

MS9238-H series

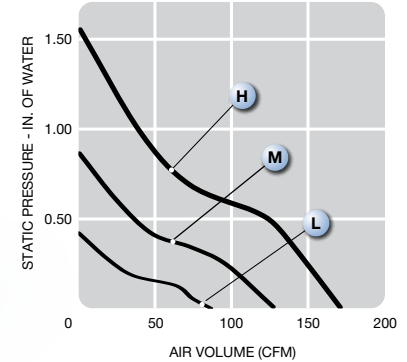
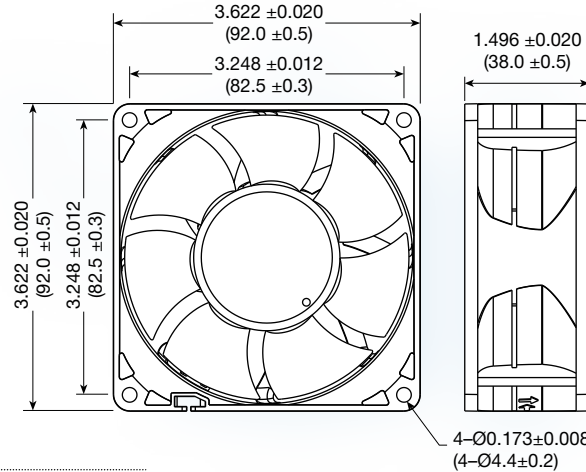

(92 x 92 x 38 mm)

3.62 x 3.62 x 1.50 inches

Features: soft start, polarity protection, auto-restart

Operating Voltage: 12, 24 and 48 VDC

Construction: UL94V-0 plastic impeller and plastic frame

Bearing option: ball bearing

Air Flow: air exhaust over struts

Options:

- tachometer;
- locked rotor alarm signal;
- PWM speed control;
- conformal coating;
- encapsulated motor (IP68)



Model No.	Rated Voltage VDC	Current A			Speed RPM	Air Volume		Max. Static Pressure (H ₂ O)		Sound Noise dbA	Weight g
		12	24	48		M ³ /Min.	CFM	MM	INCH		
MS9238L-H	12/24/48	0.34	0.16	0.08	4,000	2.28	80.7	10.17	0.40	37	202
MS9238M-H	12/24/48	1.01	0.52	0.23	6,000	3.56	125.3	22.17	0.87	56	202
MS9238H-H	12/24/48	2.57	1.26	0.60	8,000	4.72	166.7	36.90	1.45	65	202

*Additional performance levels available, contact Mechatronics for more options