

# IRLR3636PbF IRLU3636PbF

HEXFET® Power MOSFET

### Applications

- DC Motor Drive
- High Efficiency Synchronous Rectification in SMPS
- Uninterruptible Power Supply
- High Speed Power Switching
- Hard Switched and High Frequency Circuits

### Benefits

- Optimized for Logic Level Drive
- Very Low  $R_{DS(ON)}$  at 4.5V  $V_{GS}$
- Superior  $R^*Q$  at 4.5V  $V_{GS}$
- Improved Gate, Avalanche and Dynamic  $dV/dt$  Ruggedness
- Fully Characterized Capacitance and Avalanche SOA
- Enhanced body diode  $dV/dt$  and  $dI/dt$  Capability
- Lead-Free

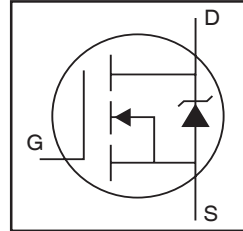

|   |              |
|---|--------------|
| $V_{DSS}$                               | <b>60V</b>   |
| $R_{DS(on)}$ <b>typ.</b><br><b>max.</b> | <b>5.4mΩ</b> |
|   | <b>6.8mΩ</b> |
| $I_D$ (Silicon Limited)                 | <b>99A</b> ① |
| $I_D$ (Package Limited)                 | <b>50A</b>   |

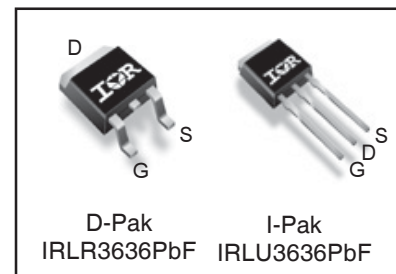

|          |          |          |
|----------|----------|----------|
| <b>G</b> | <b>D</b> | <b>S</b> |
| Gate     | Drain    | Source   |

### Absolute Maximum Ratings

| Symbol                            | Parameter   | Max.                  | Units |
|-----------------------------------|---|-----------------------|-------|
| $I_D$ @ $T_C = 25^\circ\text{C}$  | Continuous Drain Current, $V_{GS} @ 10\text{V}$ (Silicon Limited) | 99 ①                  | A     |
| $I_D$ @ $T_C = 100^\circ\text{C}$ | Continuous Drain Current, $V_{GS} @ 10\text{V}$ (Silicon Limited) | 70 ①                  |       |
| $I_D$ @ $T_C = 25^\circ\text{C}$  | Continuous Drain Current, $V_{GS} @ 10\text{V}$ (Package Limited) | 50                    |       |
| $I_{DM}$                          | Pulsed Drain Current ②  | 396                   |       |
| $P_D$ @ $T_C = 25^\circ\text{C}$  | Maximum Power Dissipation   | 143                   | W     |
|                                   | Linear Derating Factor  | 0.95                  | W/°C  |
| $V_{GS}$                          | Gate-to-Source Voltage  | ±16                   | V     |
| $dv/dt$                           | Peak Diode Recovery ④   | 22                    | V/ns  |
| $T_J$<br>$T_{STG}$                | Operating Junction and Storage Temperature Range                  | -55 to + 175          | °C    |
|                                   | Soldering Temperature, for 10 seconds                             | 300 (1.6mm from case) |       |

### Avalanche Characteristics

|                              |                                 |                          |    |
|------------------------------|---------------------------------|--------------------------|----|
| $E_{AS}$ (Thermally limited) | Single Pulse Avalanche Energy ③ | 170                      | mJ |
| $I_{AR}$                     | Avalanche Current ②             | See Fig.14, 15, 22a, 22b | A  |
| $E_{AR}$                     | Repetitive Avalanche Energy ②   |                          | mJ |

### Thermal Resistance

| Symbol          | Parameter                         | Typ. | Max. | Units |
|-----------------|-----------------------------------|------|------|-------|
| $R_{\theta JC}$ | Junction-to-Case ⑨                | —    | 1.05 | °C/W  |
| $R_{\theta JA}$ | Junction-to-Ambient (PCB Mount) ⑧ | —    | 50   |       |
| $R_{\theta JA}$ | Junction-to-Ambient               | —    | 110  |       |

Static @  $T_J = 25^\circ\text{C}$  (unless otherwise specified)

| Symbol                          | Parameter                            | Min. | Typ. | Max. | Units | Conditions   |
|---------------------------------|--------------------------------------|------|------|------|-------|--|
| $V_{(BR)DSS}$                   | Drain-to-Source Breakdown Voltage    | 60   | —    | —    | V     | $V_{GS} = 0V, I_D = 250\mu A$                        |
| $\Delta V_{(BR)DSS}/\Delta T_J$ | Breakdown Voltage Temp. Coefficient  | —    | 0.07 | —    | V/°C  | Reference to $25^\circ\text{C}$ , $I_D = 5mA$ ②      |
| $R_{DS(on)}$                    | Static Drain-to-Source On-Resistance | —    | 5.4  | 6.8  | mΩ    | $V_{GS} = 10V, I_D = 50A$ ⑤                          |
|                                 |                                      | —    | 6.6  | 8.3  |       | $V_{GS} = 4.5V, I_D = 50A$ ⑤                         |
| $V_{GS(th)}$                    | Gate Threshold Voltage               | 1.0  | —    | 2.5  | V     | $V_{DS} = V_{GS}, I_D = 100\mu A$                    |
| $I_{DSS}$                       | Drain-to-Source Leakage Current      | —    | —    | 20   | μA    | $V_{DS} = 60V, V_{GS} = 0V$                          |
|                                 |                                      | —    | —    | 250  |       | $V_{DS} = 60V, V_{GS} = 0V, T_J = 125^\circ\text{C}$ |
| $I_{GSS}$                       | Gate-to-Source Forward Leakage       | —    | —    | 100  | nA    | $V_{GS} = 16V$                                       |
|                                 | Gate-to-Source Reverse Leakage       | —    | —    | -100 |       | $V_{GS} = -16V$                                      |
| $R_{G(int)}$                    | Internal Gate Resistance             | —    | 0.6  | —    | Ω     |  |

Dynamic @  $T_J = 25^\circ\text{C}$  (unless otherwise specified)

| Symbol               | Parameter                                      | Min. | Typ. | Max. | Units | Conditions  |
|----------------------|--|------|------|------|-------|---|
| gfs                  | Forward Transconductance                       | 31   | —    | —    | S     | $V_{DS} = 25V, I_D = 50A$                         |
| $Q_g$                | Total Gate Charge                              | —    | 33   | 49   | nC    | $I_D = 50A$                                       |
| $Q_{gs}$             | Gate-to-Source Charge                          | —    | 11   | —    |       | $V_{DS} = 30V$                                    |
| $Q_{gd}$             | Gate-to-Drain ("Miller") Charge                | —    | 15   | —    |       | $V_{GS} = 4.5V$ ⑤                                 |
| $Q_{sync}$           | Total Gate Charge Sync. ( $Q_g - Q_{gd}$ )     | —    | 18   | —    |       | $I_D = 50A, V_{DS} = 0V, V_{GS} = 4.5V$           |
| $t_{d(on)}$          | Turn-On Delay Time                             | —    | 45   | —    | ns    | $V_{DD} = 39V$                                    |
| $t_r$                | Rise Time                                      | —    | 216  | —    |       | $I_D = 50A$                                       |
| $t_{d(off)}$         | Turn-Off Delay Time                            | —    | 43   | —    |       | $R_G = 7.5\ \Omega$                               |
| $t_f$                | Fall Time                                      | —    | 69   | —    |       | $V_{GS} = 4.5V$ ⑤                                 |
| $C_{iss}$            | Input Capacitance                              | —    | 3779 | —    | pF    | $V_{GS} = 0V$                                     |
| $C_{oss}$            | Output Capacitance                             | —    | 332  | —    |       | $V_{DS} = 50V$                                    |
| $C_{rss}$            | Reverse Transfer Capacitance                   | —    | 163  | —    |       | $f = 1.0MHz$                                      |
| $C_{oss\ eff. (ER)}$ | Effective Output Capacitance (Energy Related)⑦ | —    | 437  | —    |       | $V_{GS} = 0V, V_{DS} = 0V$ to $48V$ ⑦, See Fig.11 |
| $C_{oss\ eff. (TR)}$ | Effective Output Capacitance (Time Related)⑧   | —    | 636  | —    |       | $V_{GS} = 0V, V_{DS} = 0V$ to $48V$ ⑧             |

## Diode Characteristics

| Symbol    | Parameter                                 | Min.   | Typ. | Max. | Units | Conditions   |
|-----------|---|--|------|------|-------|--|
| $I_S$     | Continuous Source Current<br>(Body Diode) | —  | —    | 99 ① | A     | MOSFET symbol showing the integral reverse p-n junction diode. |
| $I_{SM}$  | Pulsed Source Current<br>(Body Diode) ②   | —  | —    | 396  |       |  |
| $V_{SD}$  | Diode Forward Voltage                     | —  | —    | 1.3  | V     | $T_J = 25^\circ\text{C}, I_S = 50A, V_{GS} = 0V$ ⑤             |
| $t_{rr}$  | Reverse Recovery Time                     | —  | 27   | —    | ns    | $T_J = 25^\circ\text{C}$ $V_R = 51V,$                          |
|           |   | —  | 32   | —    |       | $T_J = 125^\circ\text{C}$ $I_F = 50A$                          |
| $Q_{rr}$  | Reverse Recovery Charge                   | —  | 31   | —    | nC    | $T_J = 25^\circ\text{C}$ $di/dt = 100A/\mu s$ ⑤                |
|           |   | —  | 43   | —    |       | $T_J = 125^\circ\text{C}$                                      |
| $I_{RRM}$ | Reverse Recovery Current                  | —  | 2.1  | —    | A     | $T_J = 25^\circ\text{C}$                                       |
| $t_{on}$  | Forward Turn-On Time                      | Intrinsic turn-on time is negligible (turn-on is dominated by LS+LD) |      |      |       |  |

## Notes:

- ① Calculated continuous current based on maximum allowable junction temperature. Bond wire current limit is 50A. Note that current limitation arising from heating of the device leads may occur with some lead mounting arrangements.
- ② Repetitive rating; pulse width limited by max. junction temperature.
- ③ Limited by  $T_{Jmax}$ , starting  $T_J = 25^\circ\text{C}$ ,  $L = 0.136\ \text{mH}$   
 $R_G = 25\ \Omega, I_{AS} = 50A, V_{GS} = 10V$ . Part not recommended for use above this value.
- ④  $I_{SD} \leq 50A, di/dt \leq 1109\ \text{A}/\mu s, V_{DD} \leq V_{(BR)DSS}, T_J \leq 175^\circ\text{C}$ .

⑤ Pulse width  $\leq 400\mu s$ ; duty cycle  $\leq 2\%$ .

⑥  $C_{oss\ eff. (TR)}$  is a fixed capacitance that gives the same charging time as  $C_{oss}$  while  $V_{DS}$  is rising from 0 to 80%  $V_{DSS}$ .

⑦  $C_{oss\ eff. (ER)}$  is a fixed capacitance that gives the same energy as  $C_{oss}$  while  $V_{DS}$  is rising from 0 to 80%  $V_{DSS}$ .

⑧ When mounted on 1" square PCB (FR-4 or G-10 Material). For recommended footprint and soldering techniques refer to application note # AN-994 techniques refer to application note # AN-994.

⑨  $R_\theta$  is measured at  $T_J$  approximately  $90^\circ\text{C}$ .

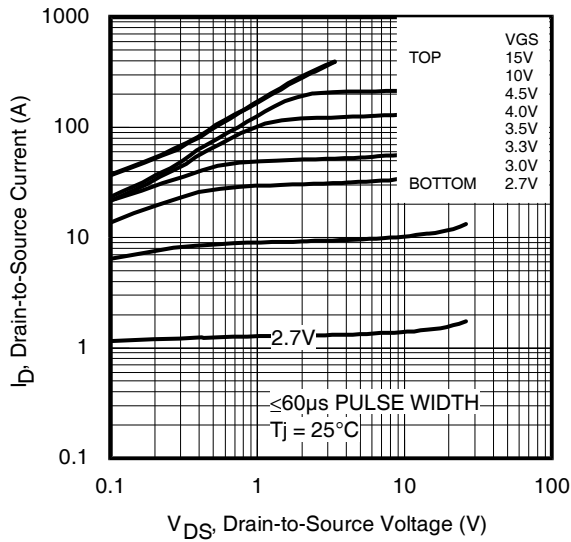

Fig 1. Typical Output Characteristics

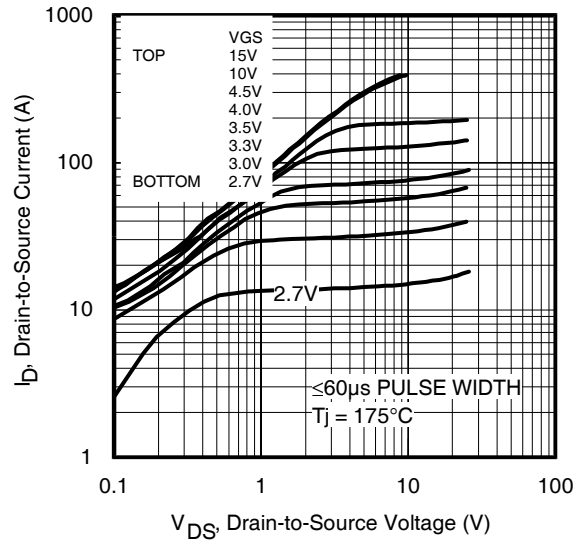

Fig 2. Typical Output Characteristics

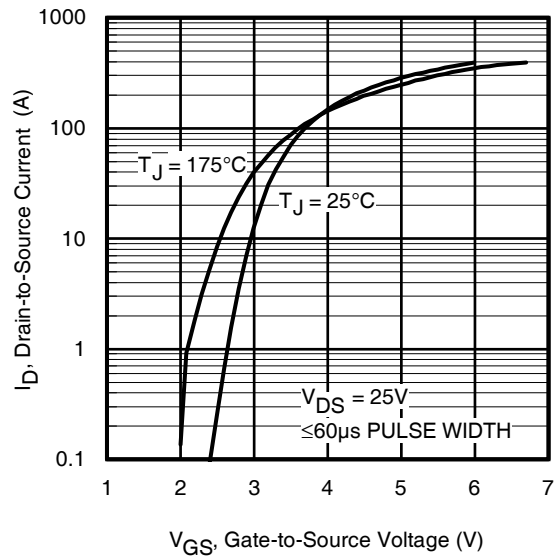

Fig 3. Typical Transfer Characteristics

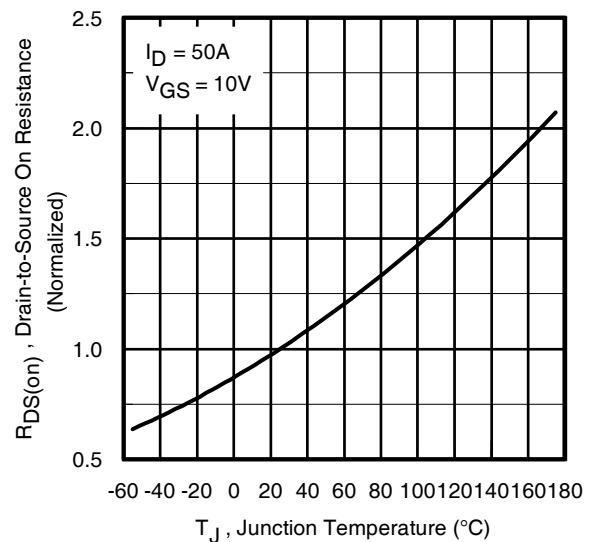

Fig 4. Normalized On-Resistance vs. Temperature

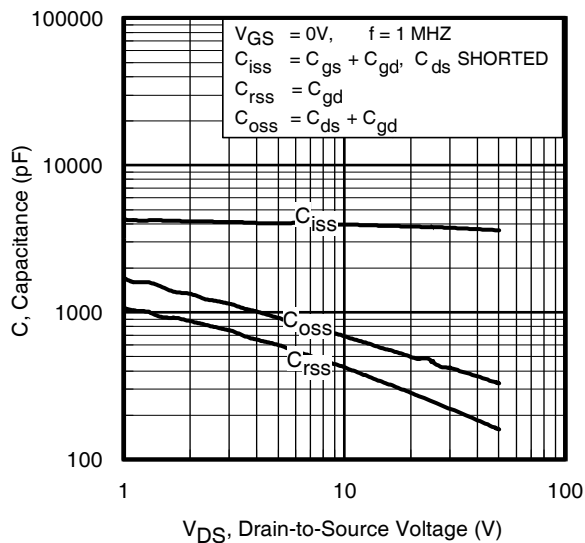

Fig 5. Typical Capacitance vs. Drain-to-Source Voltage

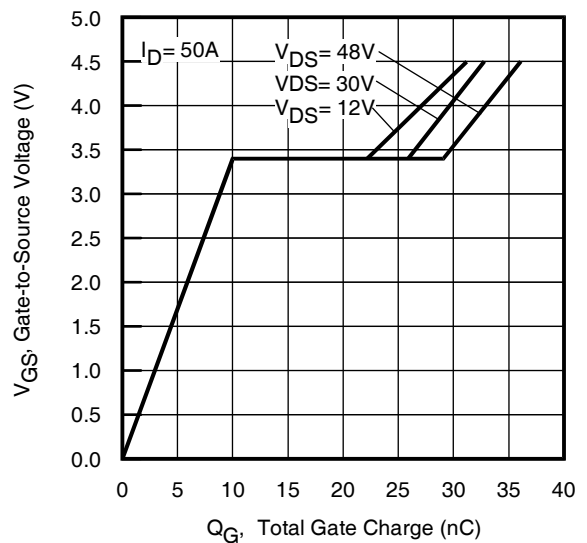
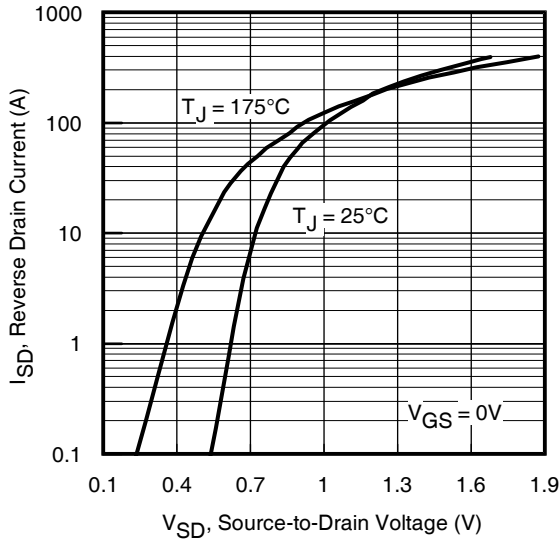
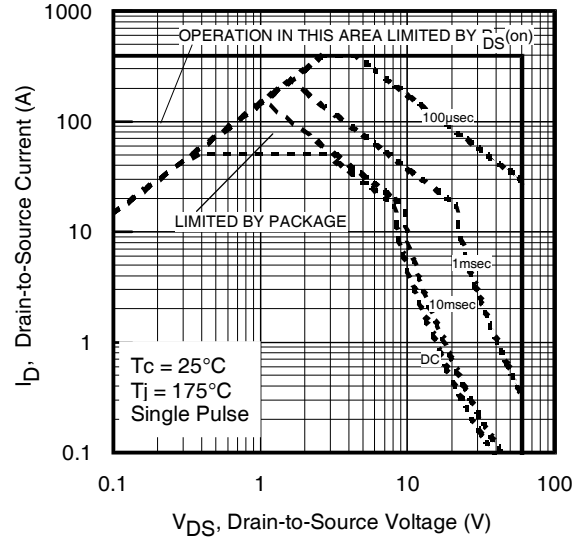

Fig 6. Typical Gate Charge vs. Gate-to-Source Voltage



**Fig 7.** Typical Source-Drain Diode Forward Voltage



**Fig 8.** Maximum Safe Operating Area

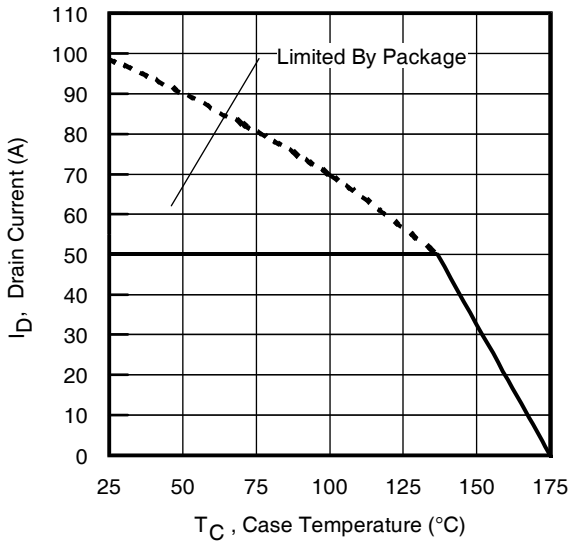

**Fig 9.** Maximum Drain Current vs. Case Temperature

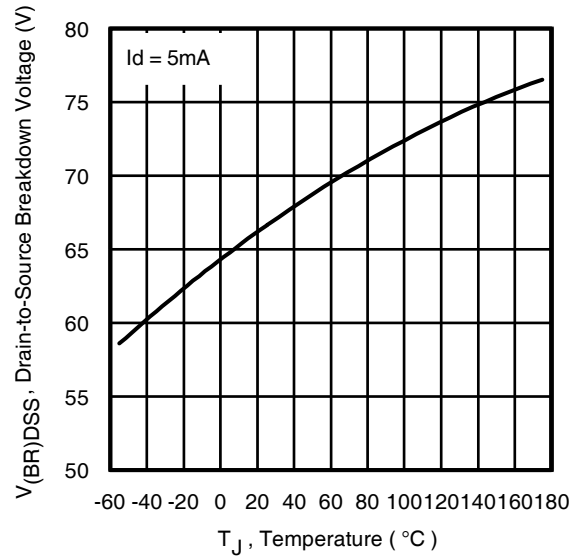

**Fig 10.** Drain-to-Source Breakdown Voltage

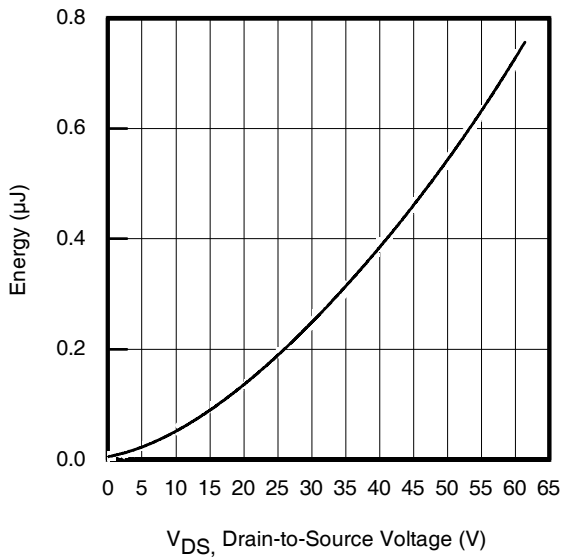

**Fig 11.** Typical  $C_{OSS}$  Stored Energy

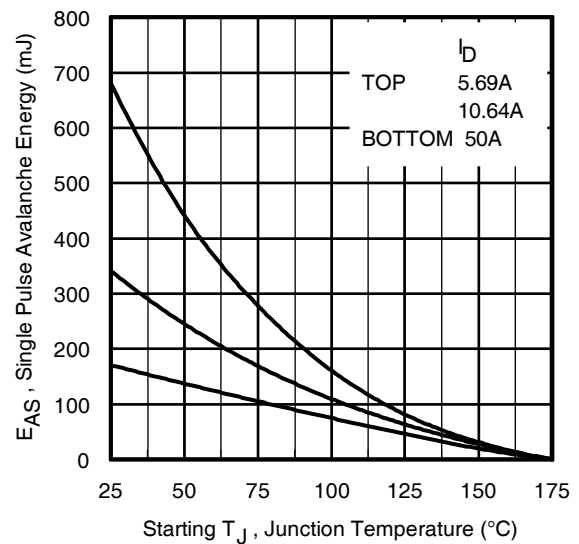

**Fig 12.** Maximum Avalanche Energy vs. Drain Current

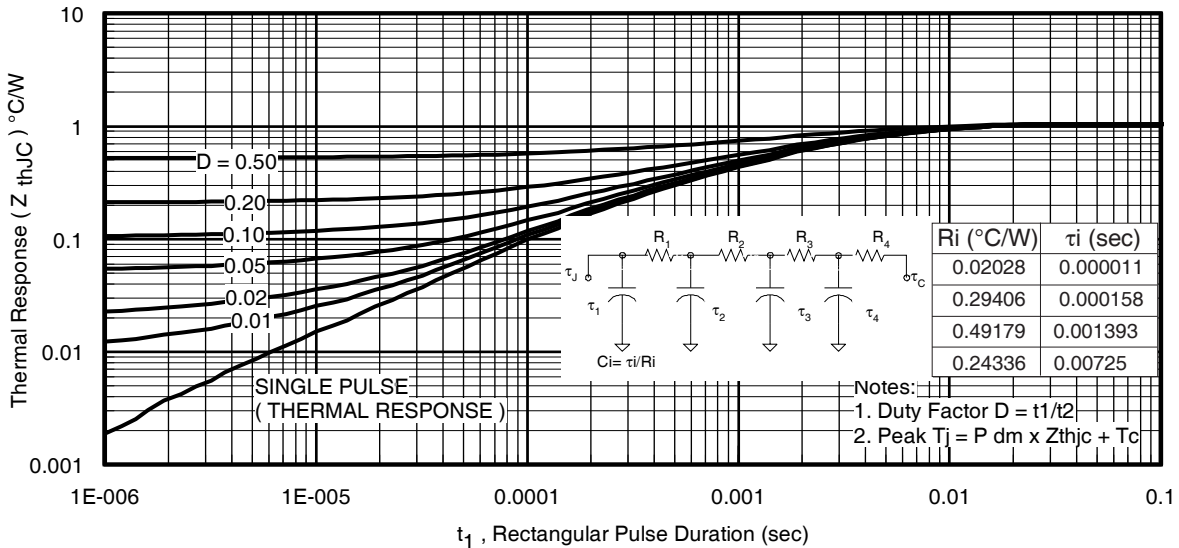

Fig 13. Maximum Effective Transient Thermal Impedance, Junction-to-Case

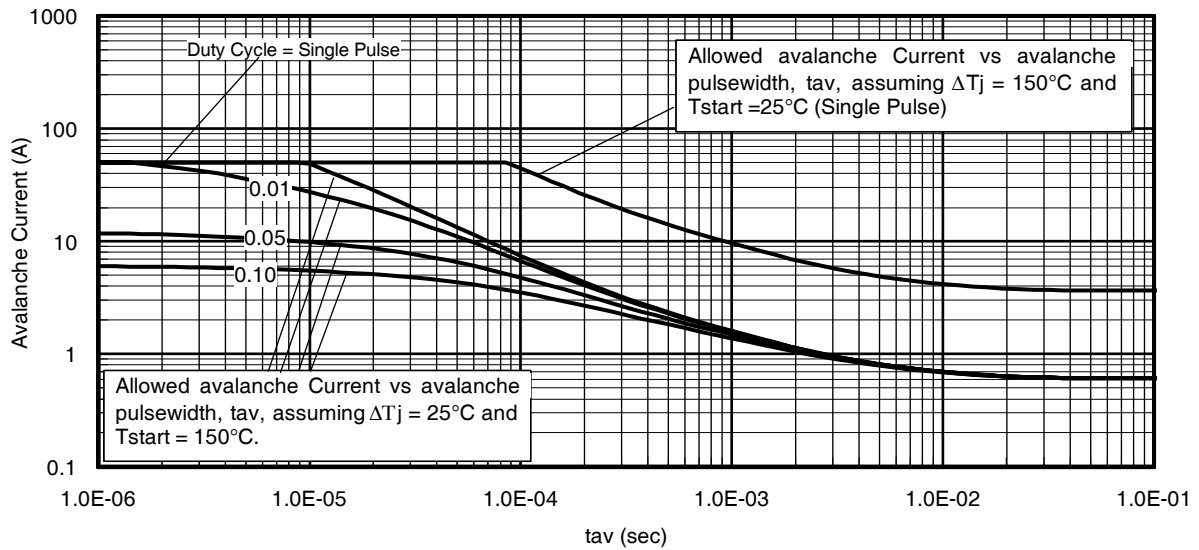
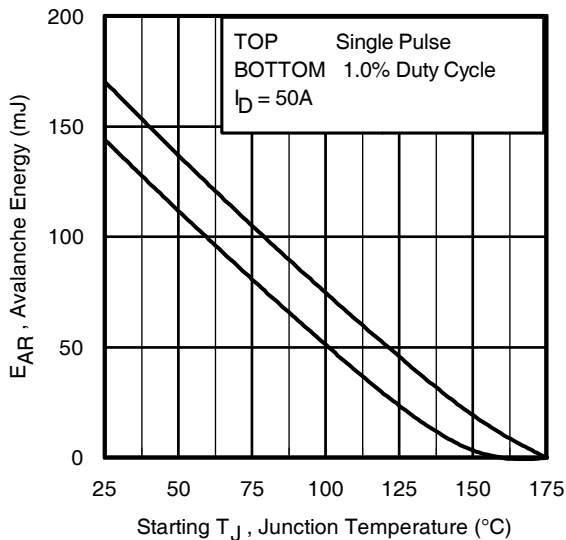

Fig 14. Typical Avalanche Current vs. Pulsewidth



**Notes on Repetitive Avalanche Curves, Figures 14, 15:**  
(For further info, see AN-1005 at [www.irf.com](http://www.irf.com))

1. Avalanche failures assumption:  
Purely a thermal phenomenon and failure occurs at a temperature far in excess of  $T_{jmax}$ . This is validated for every part type.
2. Safe operation in Avalanche is allowed as long as  $T_{jmax}$  is not exceeded.
3. Equation below based on circuit and waveforms shown in Figures 16a, 16b.
4.  $P_{D(ave)}$  = Average power dissipation per single avalanche pulse.
5. BV = Rated breakdown voltage (1.3 factor accounts for voltage increase during avalanche).
6.  $I_{av}$  = Allowable avalanche current.
7.  $\Delta T$  = Allowable rise in junction temperature, not to exceed  $T_{jmax}$  (assumed as  $25^\circ\text{C}$  in Figure 14, 15).  
 $t_{av}$  = Average time in avalanche.  
 $D$  = Duty cycle in avalanche =  $t_{av} \cdot f$   
 $Z_{thJC}(D, t_{av})$  = Transient thermal resistance, see Figures 13)

$$P_{D(ave)} = 1/2 (1.3 \cdot BV \cdot I_{av}) = \Delta T / Z_{thJC}$$

$$I_{av} = 2\Delta T / [1.3 \cdot BV \cdot Z_{th}]$$

$$E_{AS(AR)} = P_{D(ave)} \cdot t_{av}$$

Fig 15. Maximum Avalanche Energy vs. Temperature

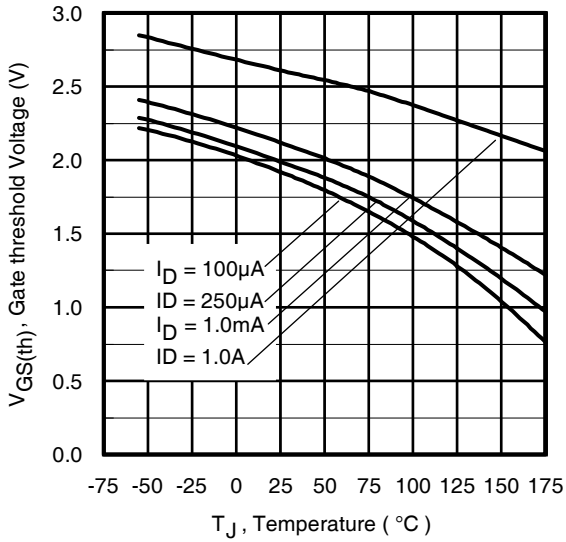

Fig 16. Threshold Voltage vs. Temperature

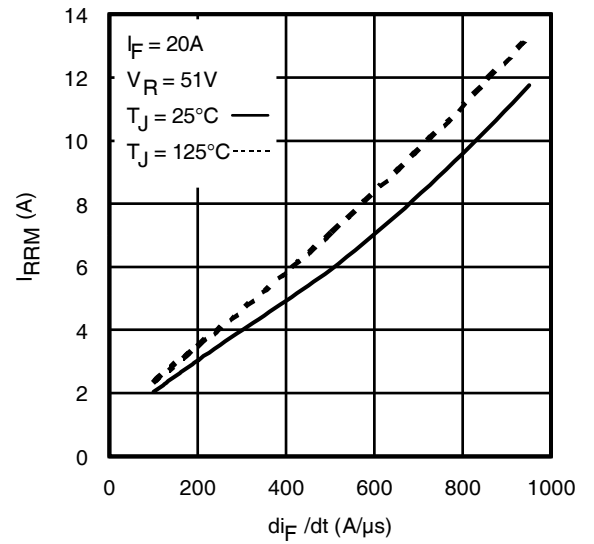

Fig. 17 - Typical Recovery Current vs.  $di_F/dt$

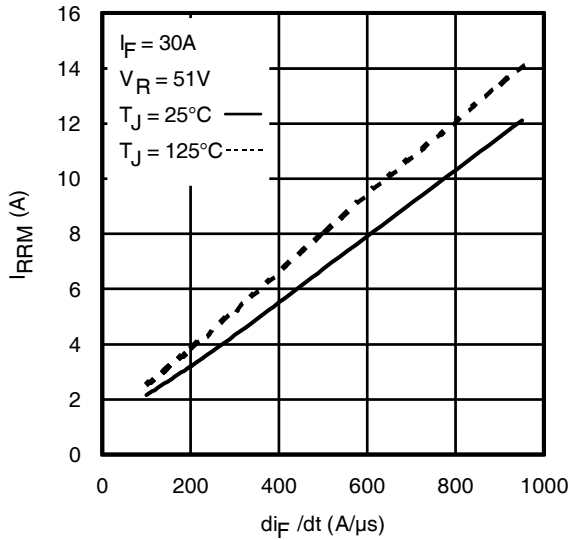

Fig. 18 - Typical Recovery Current vs.  $di_F/dt$

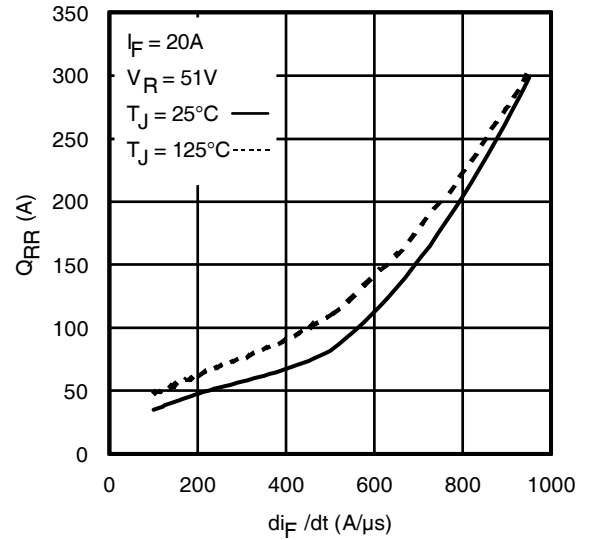

Fig. 19 - Typical Stored Charge vs.  $di_F/dt$

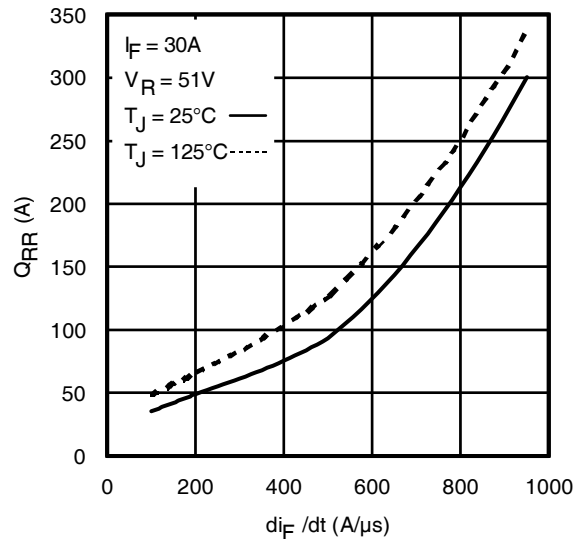

Fig. 20 - Typical Stored Charge vs.  $di_F/dt$



**Fig 21. Peak Diode Recovery dv/dt Test Circuit for N-Channel HEXFET® Power MOSFETs**



\*  $V_{GS} = 5V$  for Logic Level Devices



**Fig 22a. Unclamped Inductive Test Circuit**



**Fig 22b. Unclamped Inductive Waveforms**



**Fig 23a. Switching Time Test Circuit**



**Fig 23b. Switching Time Waveforms**



**Fig 24a. Gate Charge Test Circuit**



**Fig 24b. Gate Charge Waveform**

### D-Pak (TO-252AA) Package Outline

Dimensions are shown in millimeters (inches)

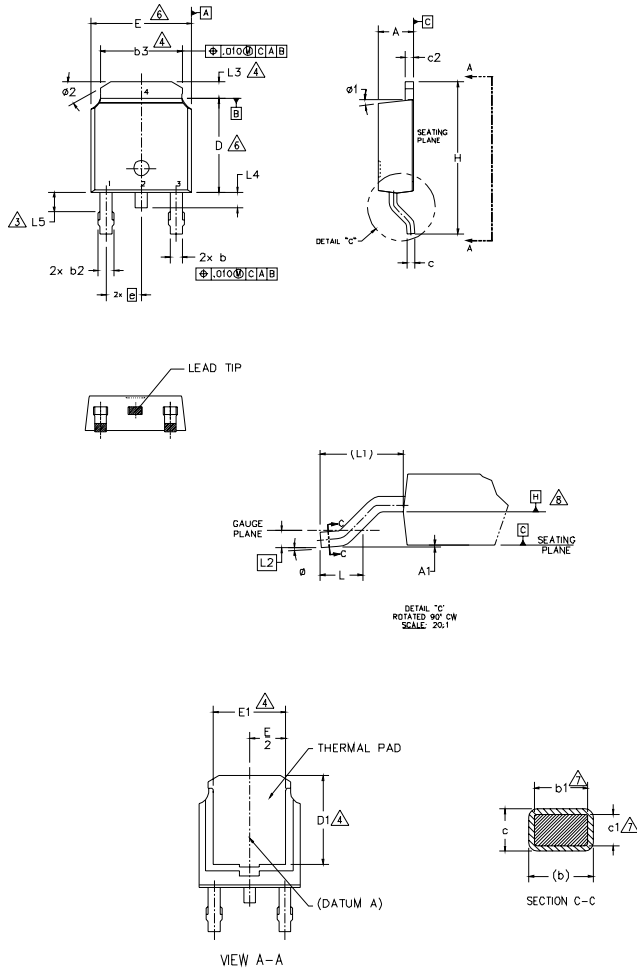

- NOTES:
- 1.- DIMENSIONING AND TOLERANCING PER ASME Y14.5M-1994
  - 2.- DIMENSION ARE SHOWN IN INCHES [MILLIMETERS].
  - 3.- LEAD DIMENSION UNCONTROLLED IN L5.
  - 4.- DIMENSION D1, E1, L3 & b3 ESTABLISH A MINIMUM MOUNTING SURFACE FOR THERMAL PAD.
  - 5.- SECTION C-C DIMENSIONS APPLY TO THE FLAT SECTION OF THE LEAD BETWEEN .005 AND 0.10 [0.13 AND 0.25] FROM THE LEAD TIP.
  - 6.- DIMENSION D & E DO NOT INCLUDE MOLD FLASH. MOLD FLASH SHALL NOT EXCEED .005 [0.13] PER SIDE. THESE DIMENSIONS ARE MEASURED AT THE OUTMOST EXTREMES OF THE PLASTIC BODY.
  - 7.- DIMENSION b1 & c1 APPLIED TO BASE METAL ONLY.
  - 8.- DATUM A & B TO BE DETERMINED AT DATUM PLANE H.
  - 9.- OUTLINE CONFORMS TO JEDEC OUTLINE TO-252AA.

| SYMBOL | DIMENSIONS  |       |           |      | NOTES |
|--------|-------------|-------|-----------|------|-------|
|        | MILLIMETERS |       | INCHES    |      |       |
|        | MIN.        | MAX.  | MIN.      | MAX. |       |
| A      | 2.18        | 2.39  | .086      | .094 |       |
| A1     | -           | 0.13  | -         | .005 |       |
| b      | 0.64        | 0.89  | .025      | .035 |       |
| b1     | 0.65        | 0.79  | .025      | .031 | 7     |
| b2     | 0.76        | 1.14  | .030      | .045 |       |
| b3     | 4.95        | 5.46  | .195      | .215 | 4     |
| c      | 0.46        | 0.61  | .018      | .024 |       |
| c1     | 0.41        | 0.56  | .016      | .022 | 7     |
| c2     | 0.46        | 0.89  | .018      | .035 |       |
| D      | 5.97        | 6.22  | .235      | .245 | 6     |
| D1     | 5.21        | -     | .205      | -    | 4     |
| E      | 6.35        | 6.73  | .250      | .265 | 6     |
| E1     | 4.32        | -     | .170      | -    | 4     |
| e      | 2.29 BSC    |       | .090 BSC  |      |       |
| H      | 9.40        | 10.41 | .370      | .410 |       |
| L      | 1.40        | 1.78  | .055      | .070 |       |
| L1     | 2.74 BSC    |       | .108 REF. |      |       |
| L2     | 0.51 BSC    |       | .020 BSC  |      |       |
| L3     | 0.89        | 1.27  | .035      | .050 |       |
| L4     | -           | 1.02  | -         | .040 |       |
| L5     | 1.14        | 1.52  | .045      | .060 | 3     |
| ø      | 0"          | 10"   | 0"        | 10"  |       |
| ø1     | 0"          | 15"   | 0"        | 15"  |       |
| ø2     | 25"         | 35"   | 25"       | 35"  |       |

LEAD ASSIGNMENTS

HEXFET

- 1.- GATE
- 2.- DRAIN
- 3.- SOURCE
- 4.- DRAIN

IGBT & CoPAK

- 1.- GATE
- 2.- COLLECTOR
- 3.- EMITTER
- 4.- COLLECTOR

### D-Pak (TO-252AA) Part Marking Information

EXAMPLE: THIS IS AN IRFR120  
WITH ASSEMBLY  
LOT CODE 1234  
ASSEMBLED ON WW 16, 2001  
IN THE ASSEMBLY LINE "A"

Note: "P" in assembly line position  
indicates "Lead-Free"

"P" in assembly line position indicates  
"Lead-Free" qualification to the consumer-level

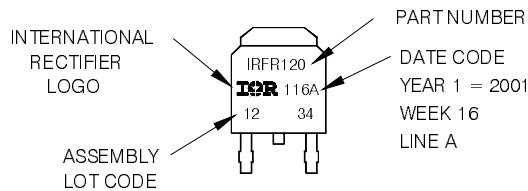

OR

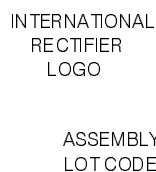

PART NUMBER

DATE CODE  
P = DESIGNATES LEAD-FREE  
PRODUCT (OPTIONAL)

P̄ = DESIGNATES LEAD-FREE  
PRODUCT QUALIFIED TO THE  
CONSUMER LEVEL (OPTIONAL)

YEAR 1 = 2001  
WEEK 16  
A = ASSEMBLY SITE CODE

Note: For the most current drawing please refer to IR website at <http://www.irf.com/package/>





D-Pak (TO-252AA) Tape & Reel Information

Dimensions are shown in millimeters (inches)

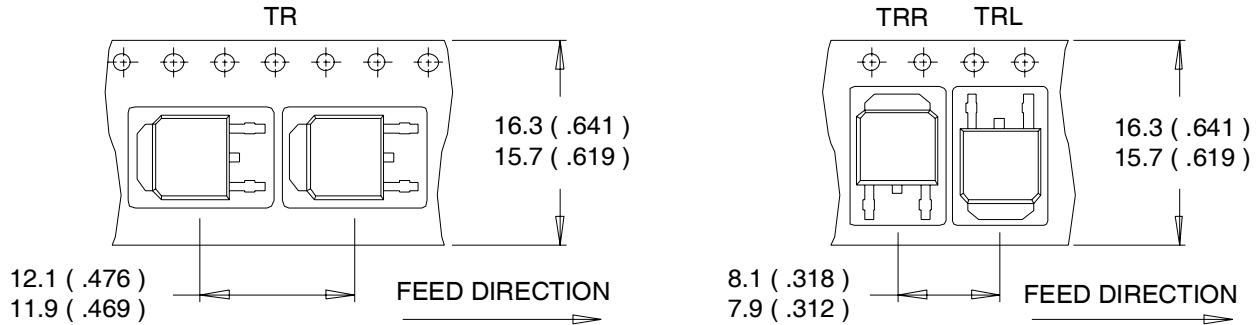

NOTES :

1. CONTROLLING DIMENSION : MILLIMETER.
2. ALL DIMENSIONS ARE SHOWN IN MILLIMETERS ( INCHES ).
3. OUTLINE CONFORMS TO EIA-481 & EIA-541.

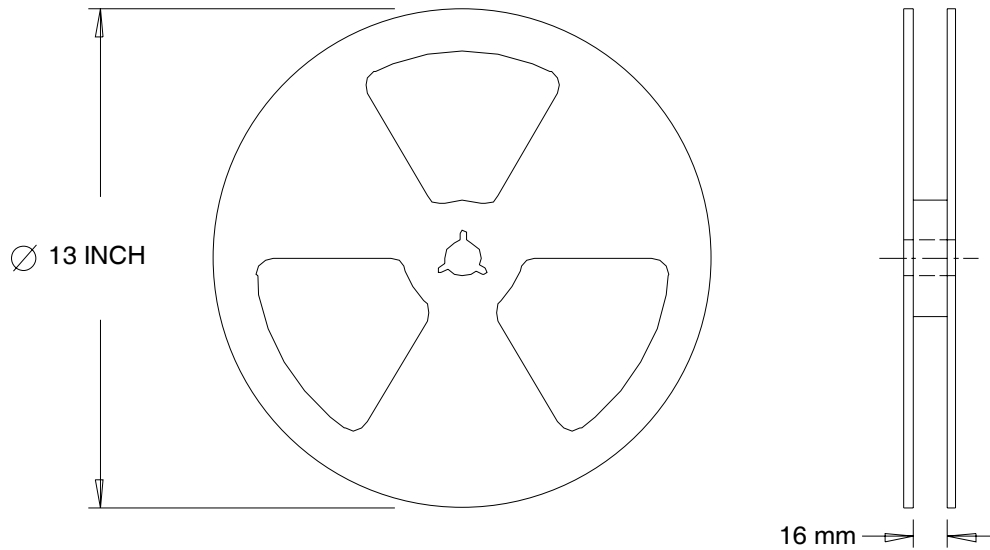

NOTES :

1. OUTLINE CONFORMS TO EIA-481.

Note: For the most current drawing please refer to IR website at <http://www.irf.com/package/>

Data and specifications subject to change without notice.  
 This product has been designed and qualified for the Industrial market.  
 Qualification Standards can be found on IR's Web site.