

**OptiMOS<sup>™</sup>3 Power-Transistor**
**Features**

- Ideal for high frequency switching and sync. rec.
- Optimized technology for DC/DC converters
- Excellent gate charge x  $R_{DS(on)}$  product (FOM)
- Very low on-resistance  $R_{DS(on)}$
- N-channel, normal level
- 100% avalanche tested
- Pb-free plating; RoHS compliant
- Qualified according to JEDEC<sup>1)</sup> for target applications
- Halogen-free according to IEC61249-2-21

**Product Summary**

$V_{DS}$	80	V
$R_{DS(on),max}$	2.8	m $\Omega$
$I_D$	89	A

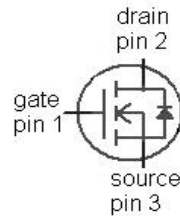

<b>Type</b>	IPA028N08N3 G
<b>Package</b>	PG-TO-220-FP
<b>Marking</b>	028N08N

**Maximum ratings**, at  $T_j=25\text{ °C}$ , unless otherwise specified

Parameter	Symbol	Conditions	Value	Unit
Continuous drain current	$I_D$	$T_C=25\text{ °C}^{2)}$	89	A
		$T_C=100\text{ °C}$	62	
Pulsed drain current <sup>3)</sup>	$I_{D,pulse}$	$T_C=25\text{ °C}$	352	
Avalanche energy, single pulse <sup>4)</sup>	$E_{AS}$	$I_D=89\text{ A}, R_{GS}=25\ \Omega$	1430	mJ
Gate source voltage	$V_{GS}$		$\pm 20$	V
Power dissipation	$P_{tot}$	$T_C=25\text{ °C}$	42	W
Operating and storage temperature	$T_j, T_{stg}$		-55 ... 175	°C
IEC climatic category; DIN IEC 68-1			55/175/56	

<sup>1)</sup>J-STD20 and JESD22

<sup>2)</sup> Current is limited by package; with an  $R_{thJC}=0.5K/W$  in a standard TO-220 package the chip is able to carry 251A.

<sup>3)</sup> See figure 3 for more detailed information

<sup>4)</sup> See figure 13 for more detailed information

Parameter	Symbol	Conditions	Values			Unit
			min.	typ.	max.	
<b>Thermal characteristics</b>						
Thermal resistance, junction - case	$R_{thJC}$		-	-	3.6	K/W
<b>Electrical characteristics, at <math>T_j=25\text{ °C}</math>, unless otherwise specified</b>						
<b>Static characteristics</b>						
Drain-source breakdown voltage	$V_{(BR)DSS}$	$V_{GS}=0\text{ V}, I_D=1\text{ mA}$	80	-	-	V
Gate threshold voltage	$V_{GS(th)}$	$V_{DS}=V_{GS}, I_D=270\text{ }\mu\text{A}$	2	2.8	3.5	
Zero gate voltage drain current	$I_{DSS}$	$V_{DS}=80\text{ V}, V_{GS}=0\text{ V}, T_j=25\text{ °C}$	-	0.1	1	$\mu\text{A}$
		$V_{DS}=80\text{ V}, V_{GS}=0\text{ V}, T_j=125\text{ °C}$	-	10	100	
Gate-source leakage current	$I_{GSS}$	$V_{GS}=20\text{ V}, V_{DS}=0\text{ V}$	-	1	100	nA
Drain-source on-state resistance	$R_{DS(on)}$	$V_{GS}=10\text{ V}, I_D=89\text{ A}$	-	2.4	2.8	m $\Omega$
		$V_{GS}=6\text{ V}, I_D=44\text{ A}$	-	2.8	4.2	
Gate resistance	$R_G$		-	2.7	-	$\Omega$
Transconductance	$g_{fs}$	$ V_{DS} >2 I_D R_{DS(on)max}, I_D=89\text{ A}$	89	178	-	S

Parameter	Symbol	Conditions	Values			Unit
			min.	typ.	max.	

**Dynamic characteristics**

Input capacitance	$C_{iss}$	$V_{GS}=0\text{ V}, V_{DS}=40\text{ V},$ $f=1\text{ MHz}$	-	10700	14200	pF
Output capacitance	$C_{oss}$		-	2890	3840	
Reverse transfer capacitance	$C_{rss}$		-	100	-	
Turn-on delay time	$t_{d(on)}$	$V_{DD}=40\text{ V}, V_{GS}=10\text{ V},$ $I_D=89\text{ A}, R_{G,ext}=1.6\ \Omega$	-	30	-	ns
Rise time	$t_r$		-	59	-	
Turn-off delay time	$t_{d(off)}$		-	77	-	
Fall time	$t_f$		-	26	-	

**Gate Charge Characteristics<sup>5)</sup>**

Gate to source charge	$Q_{gs}$	$V_{DD}=40\text{ V}, I_D=89\text{ A},$ $V_{GS}=0\text{ to }10\text{ V}$	-	50	-	nC
Gate to drain charge	$Q_{gd}$		-	30	-	
Switching charge	$Q_{sw}$		-	50	-	
Gate charge total	$Q_g$		-	155	206	
Gate plateau voltage	$V_{plateau}$		-	4.6	-	
Output charge	$Q_{oss}$	$V_{DD}=40\text{ V}, V_{GS}=0\text{ V}$	-	210	279	nC

**Reverse Diode**

Diode continuous forward current	$I_S$	$T_C=25\text{ }^\circ\text{C}$	-	-	89	A
Diode pulse current	$I_{S,pulse}$		-	-	356	
Diode forward voltage	$V_{SD}$	$V_{GS}=0\text{ V}, I_F=89\text{ A},$ $T_j=25\text{ }^\circ\text{C}$	-	0.9	1.2	V
Reverse recovery time	$t_{rr}$	$V_R=40\text{ V}, I_F=I_S,$ $di_F/dt=100\text{ A}/\mu\text{s}$	-	78	-	ns
Reverse recovery charge	$Q_{rr}$		-	181	-	nC

<sup>5)</sup> See figure 16 for gate charge parameter definition

### 1 Power dissipation

$$P_{tot}=f(T_C)$$

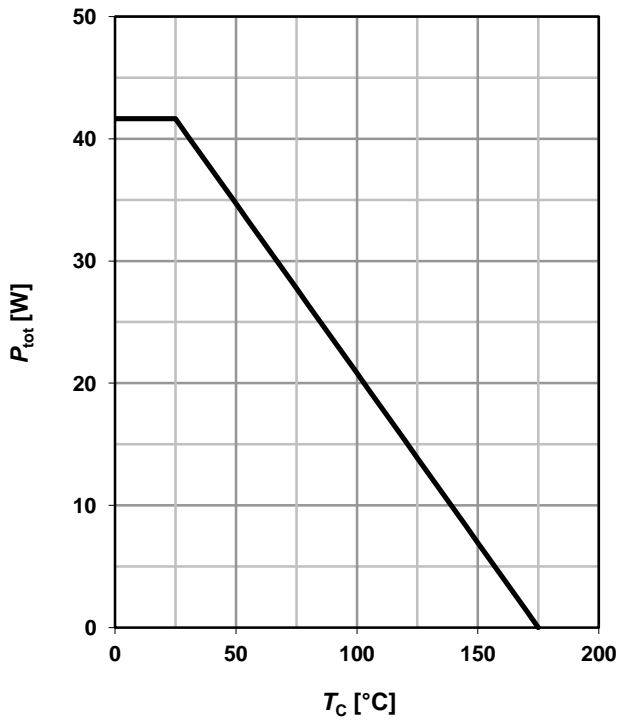

### 2 Drain current

$$I_D=f(T_C); V_{GS} \geq 10 \text{ V}$$

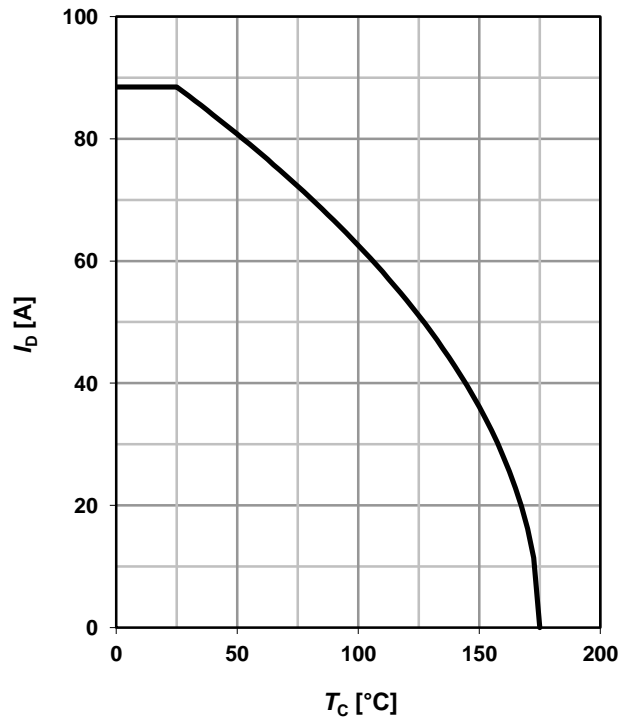

### 3 Safe operating area

$$I_D=f(V_{DS}); T_C=25 \text{ °C}; D=0$$

parameter:  $t_p$

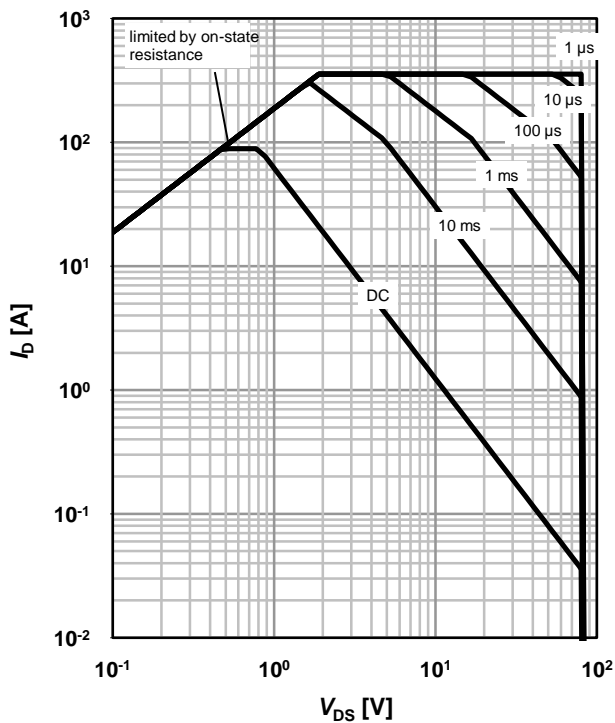

### 4 Max. transient thermal impedance

$$Z_{thJC}=f(t_p)$$

parameter:  $D=t_p/T$

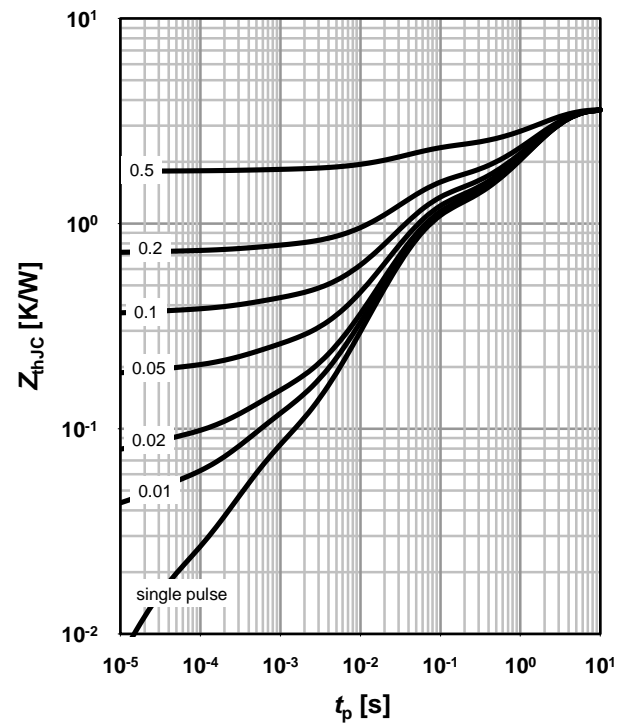

**5 Typ. output characteristics**

$I_D=f(V_{DS}); T_j=25\text{ }^\circ\text{C}$

parameter:  $V_{GS}$

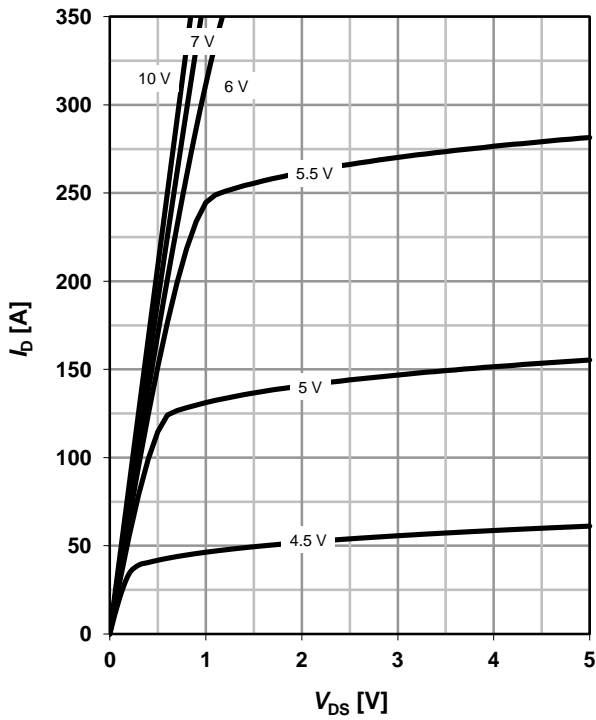

**6 Typ. drain-source on resistance**

$R_{DS(on)}=f(I_D); T_j=25\text{ }^\circ\text{C}$

parameter:  $V_{GS}$

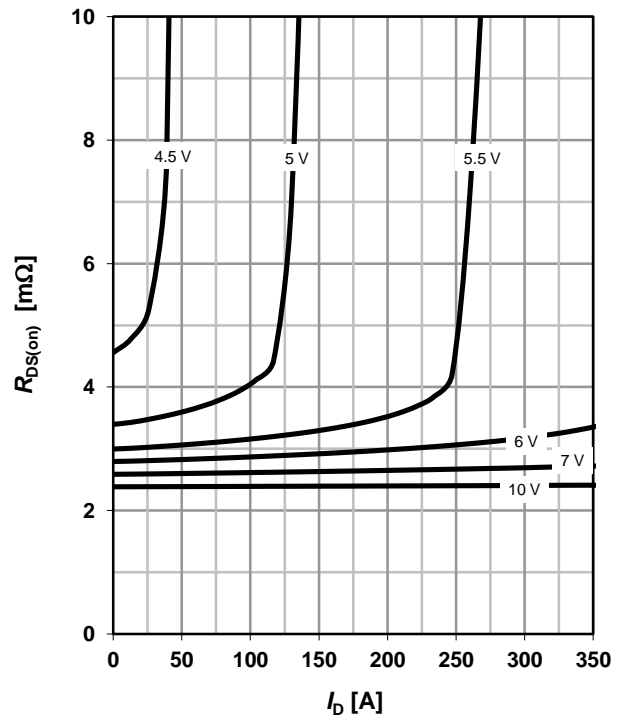

**7 Typ. transfer characteristics**

$I_D=f(V_{GS}); |V_{DS}|>2|I_D|R_{DS(on)max}$

parameter:  $T_j$

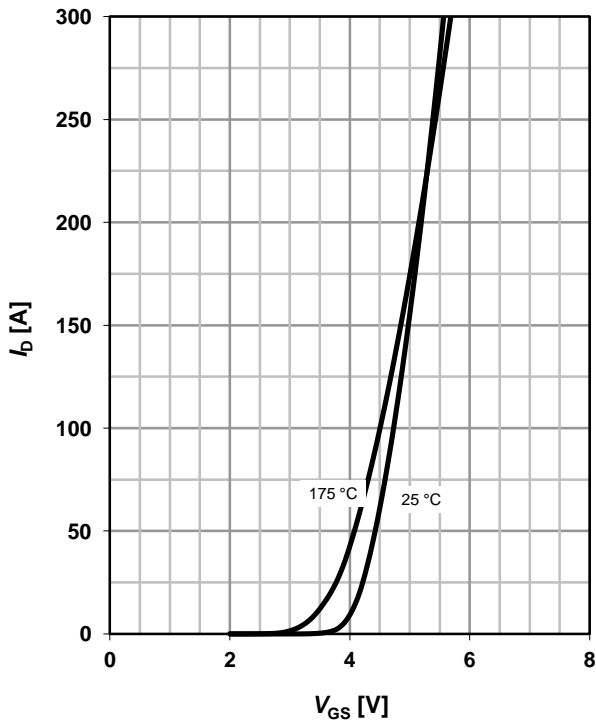

**8 Typ. forward transconductance**

$g_{fs}=f(I_D); T_j=25\text{ }^\circ\text{C}$

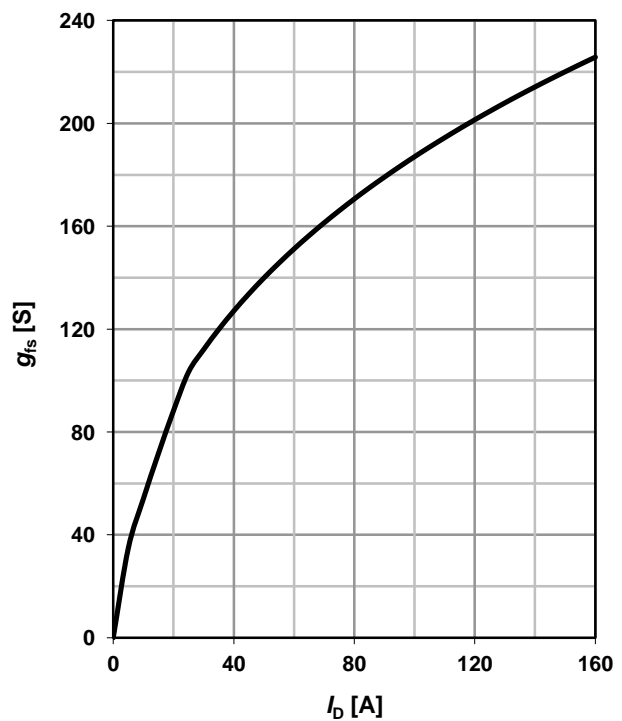

**9 Drain-source on-state resistance**

$R_{DS(on)}=f(T_j)$ ;  $I_D=89\text{ A}$ ;  $V_{GS}=10\text{ V}$

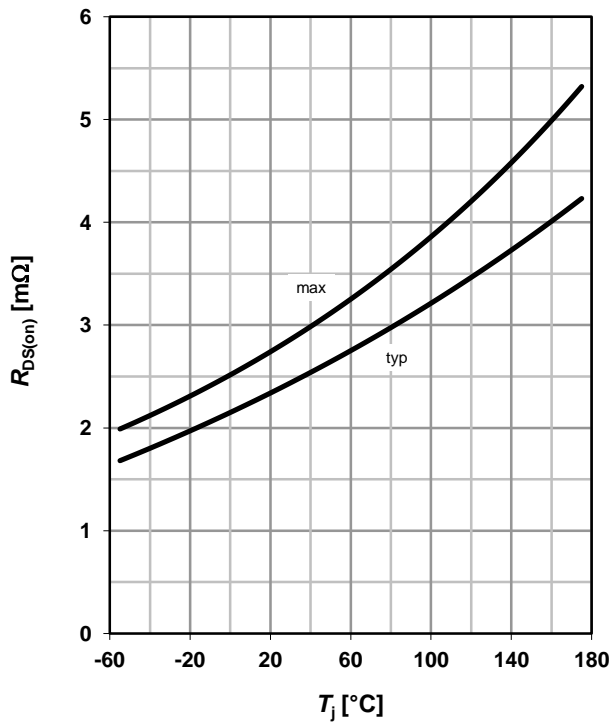

**10 Typ. gate threshold voltage**

$V_{GS(th)}=f(T_j)$ ;  $V_{GS}=V_{DS}$

parameter:  $I_D$

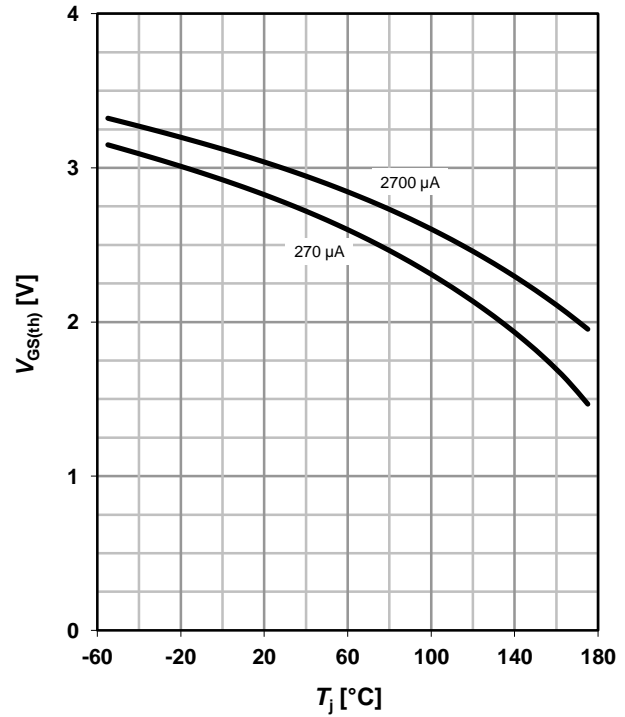

**11 Typ. capacitances**

$C=f(V_{DS})$ ;  $V_{GS}=0\text{ V}$ ;  $f=1\text{ MHz}$

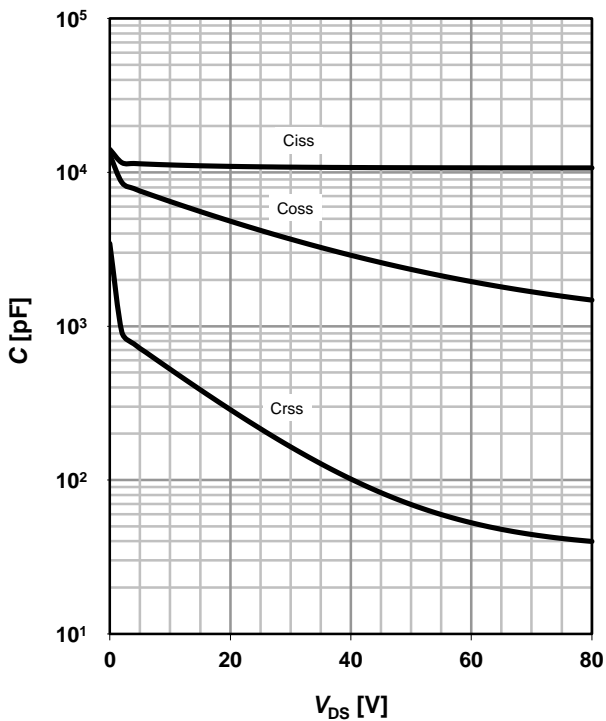

**12 Forward characteristics of reverse diode**

$I_F=f(V_{SD})$

parameter:  $T_j$

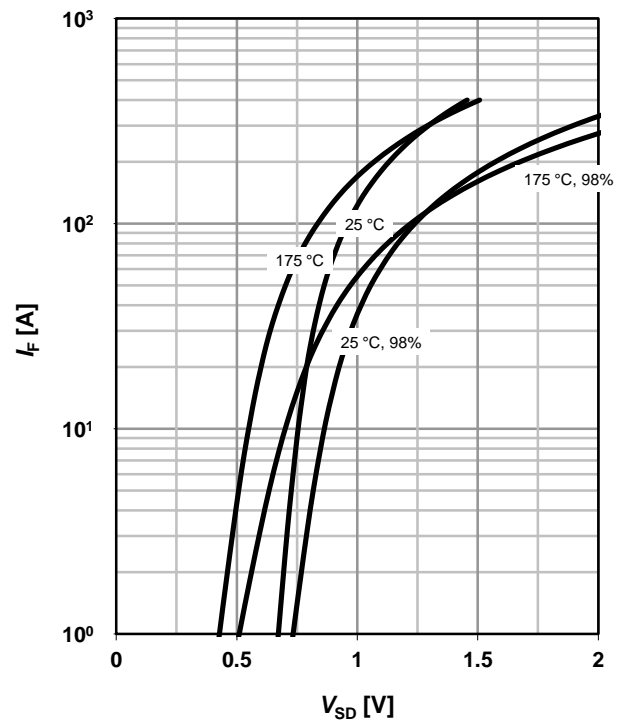

**13 Avalanche characteristics**

$I_{AS}=f(t_{AV}); R_{GS}=25 \Omega$

parameter:  $T_{j(\text{start})}$

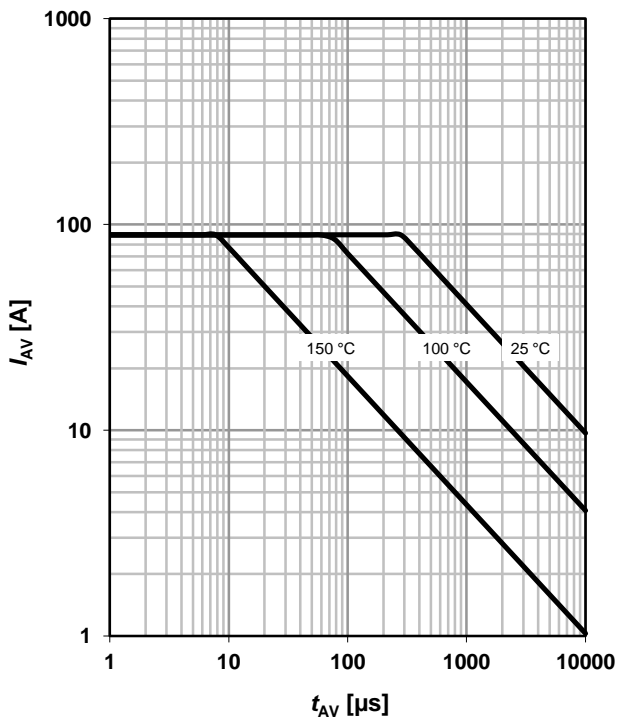

**14 Typ. gate charge**

$V_{GS}=f(Q_{\text{gate}}); I_D=89\text{A pulsed}$

parameter:  $V_{DD}$

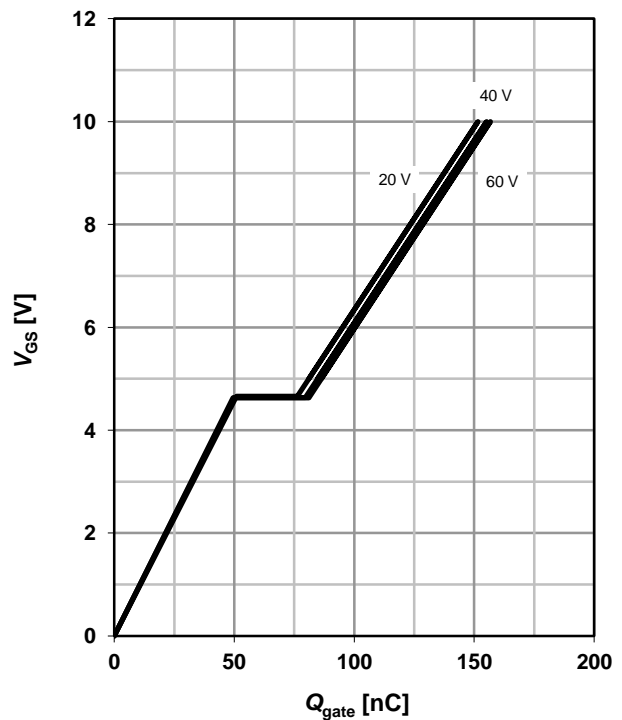

**15 Drain-source breakdown voltage**

$V_{BR(DSS)}=f(T_j); I_D=1 \text{ mA}$

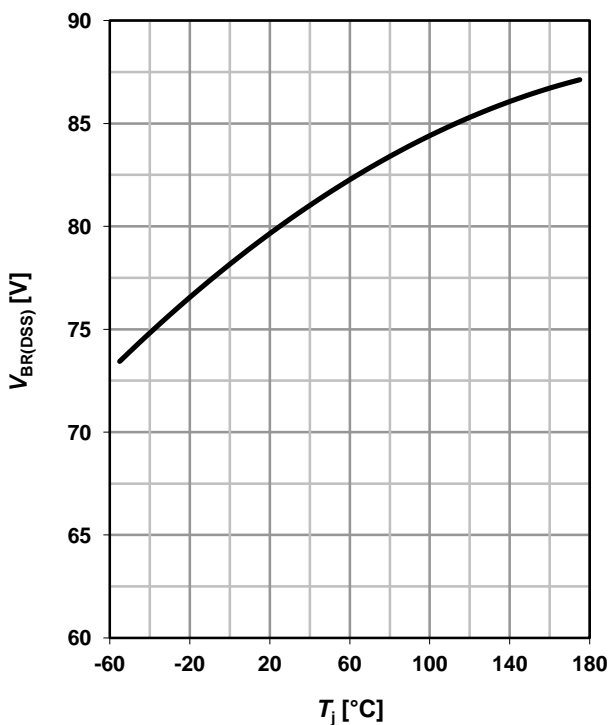

**16 Gate charge waveforms**

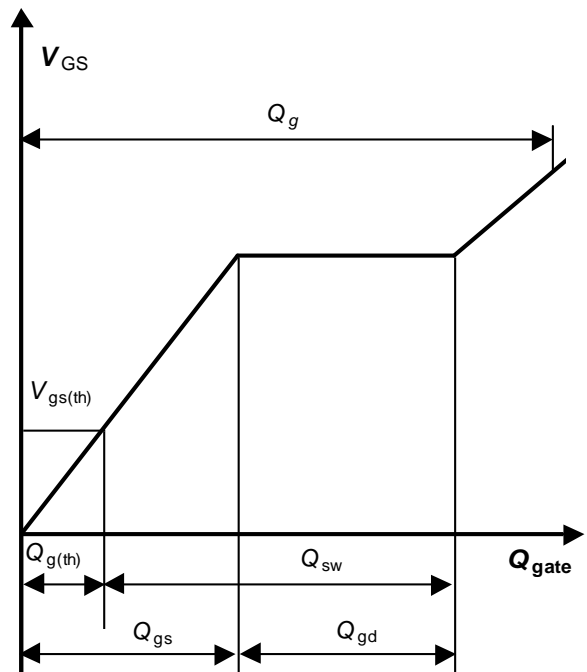

PG-TO-220-FP

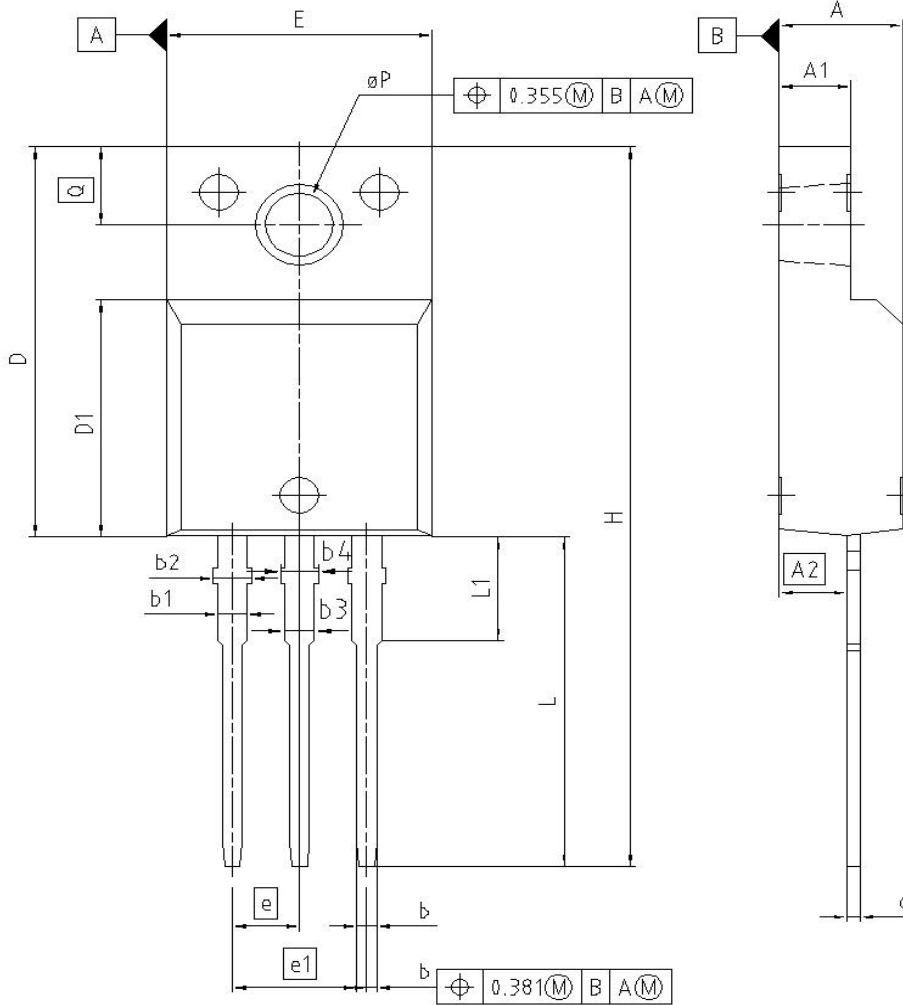

DIM	MILLIMETERS		INCHES	
	MIN	MAX	MIN	MAX
A	4.55	4.85	0.179	0.191
A1	2.55	2.85	0.100	0.112
A2	2.42	2.72	0.095	0.107
b	0.65	0.85	0.026	0.033
b1	0.95	1.33	0.037	0.052
b2	0.95	1.51	0.037	0.059
b3	0.65	1.33	0.026	0.052
b4	0.65	1.51	0.026	0.059
c	0.40	0.63	0.016	0.025
D	15.85	16.15	0.624	0.636
D1	9.53	9.83	0.375	0.387
E	10.35	10.65	0.407	0.419
e	2.54		0.100	
e1	5.08		0.200	
N	3		3	
H	29.45	29.75	1.159	1.171
L	13.45	13.75	0.530	0.541
L1	3.15	3.45	0.124	0.136
øP	2.95	3.20	0.116	0.126
Q	3.15	3.50	0.124	0.138

REFERENCE  
./...

SCALE  
0 2.5 5mm

EUROPEAN PROJECTION

ISSUE DATE  
08-01-2007

FILE  
TO220\_2



**Published by**  
**Infineon Technologies AG**  
**81726 Munich, Germany**  
**© 2009 Infineon Technologies AG**  
**All Rights Reserved.**

#### **Legal Disclaimer**

The information given in this document shall in no event be regarded as a guarantee of conditions or characteristics. With respect to any examples or hints given herein, any typical Infineon Technologies hereby disclaims any and all warranties and liabilities of any kind, including without limitation, warranties of non-infringement of intellectual property rights of any third party.

#### **Information**

For further information on technology, delivery terms and conditions and prices, please contact the nearest Infineon Technologies Office ([www.infineon.com](http://www.infineon.com)).

#### **Warnings**

Due to technical requirements, components may contain dangerous substances. For information on the types in question, please contact the nearest Infineon Technologies Office.

Infineon Technologies components may be used in life-support devices or systems only with the express written approval of Infineon Technologies, if a failure of such components can reasonably be expected to cause the failure of that life-support device or system or to affect the safety or effectiveness of that device or system. Life support devices or systems are intended to be implanted in the human body or to support and/or maintain and sustain and/or protect human life. If they fail, it is reasonable to assume that the health of the user or other persons may be endangered.