

# Polar™ Power MOSFET

## HiPerFET™

# IXFL44N100P

N-Channel Enhancement Mode  
Avalanche Rated  
Fast Intrinsic Diode

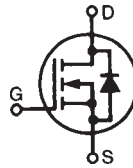

$V_{DSS} = 1000V$   
 $I_{D25} = 22A$   
 $R_{DS(on)} \leq 240m\Omega$   
 $t_{rr} \leq 300ns$

ISOPLUS i5-Pak™ (HV)

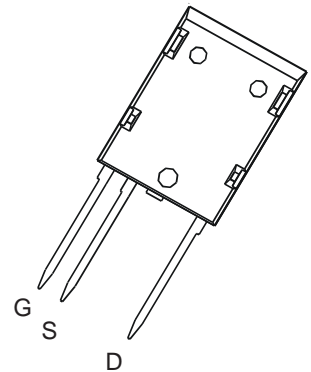

G = Gate  
S = Source  
D = Drain

Symbol	Test Conditions	Maximum Ratings	
		Value	Unit
$V_{DSS}$	$T_J = 25^\circ C$ to $150^\circ C$	1000	V
$V_{DGR}$	$T_J = 25^\circ C$ to $150^\circ C$ , $R_{GS} = 1M\Omega$	1000	V
$V_{GSS}$	Continuous	$\pm 30$	V
$V_{GSM}$	Transient	$\pm 40$	V
$I_{D25}$	$T_C = 25^\circ C$	22	A
$I_{DM}$	$T_C = 25^\circ C$ , pulse width limited by $T_{JM}$	110	A
$I_{AR}$	$T_C = 25^\circ C$	22	A
$E_{AS}$	$T_C = 25^\circ C$	2	J
$dV/dt$	$I_S \leq I_{DM}$ , $V_{DD} \leq V_{DSS}$ , $T_J \leq 150^\circ C$	15	V/ns
$P_D$	$T_C = 25^\circ C$	357	W
$T_J$		-55 ... +150	$^\circ C$
$T_{JM}$		150	$^\circ C$
$T_{stg}$		-55 ... +150	$^\circ C$
$T_L$	Maximum lead temperature for soldering	300	$^\circ C$
$T_{SOLD}$	Plastic body for 10s	260	$^\circ C$
$V_{ISOL}$	50/60 Hz, RMS, 1 minute	2500	V~
	$I_{ISOL} \leq 1mA$ $t = 1s$	3000	V~
$F_C$	Mounting force	40..120/4.5..27	N/lb.
<b>Weight</b>		8	g

### Features

- Silicon chip on Direct-Copper-Bond substrate
  - High power dissipation
  - Isolated mounting surface
  - 2500V electrical isolation
- Low drain to tab capacitance(<30pF)
- Rugged polysilicon gate cell structure
- Unclamped Inductive Switching (UIS) rated
- Fast intrinsic Rectifier

### Applications

- Switched-mode and resonant-mode power supplies
- DC-DC converters
- Laser Drivers
- AC and DC motor controls
- Robotics and servo controls

### Advantages

- Easy assembly
- Space savings
- High power density

Symbol	Test Conditions	Characteristic Values		
		Min.	Typ.	Max.
$BV_{DSS}$	$V_{GS} = 0V$ , $I_D = 3mA$	1000		V
$V_{GS(th)}$	$V_{DS} = V_{GS}$ , $I_D = 1mA$	3.5		6.5 V
$I_{GSS}$	$V_{GS} = \pm 30V$ , $V_{DS} = 0V$			$\pm 200$ nA
$I_{DSS}$	$V_{DS} = V_{DSS}$ $V_{GS} = 0V$ $T_J = 125^\circ C$			50 $\mu A$ 3 mA
$R_{DS(on)}$	$V_{GS} = 10V$ , $I_D = 22A$ , Note 1			240 m $\Omega$

Symbol	Test Conditions ( $T_J = 25^\circ\text{C}$ unless otherwise specified)	Characteristic Values		
		Min.	Typ.	Max.
$g_{fs}$	$V_{DS} = 20\text{V}, I_D = 22\text{A}$ , Note 1	20	35	S
$C_{iss}$	$V_{GS} = 0\text{V}, V_{DS} = 25\text{V}, f = 1\text{MHz}$		19	nF
$C_{oss}$			1060	pF
$C_{rss}$			41	pF
$R_{Gi}$	Gate input resistance		1.70	$\Omega$
$t_{d(on)}$	<b>Resistive Switching Times</b> $V_{GS} = 10\text{V}, V_{DS} = 0.5 \cdot V_{DSS}, I_D = 22\text{A}$ $R_G = 1\Omega$ (External)		60	ns
$t_r$			68	ns
$t_{d(off)}$			90	ns
$t_f$			54	ns
$Q_{g(on)}$	$V_{GS} = 10\text{V}, V_{DS} = 0.5 \cdot V_{DSS}, I_D = 22\text{A}$		305	nC
$Q_{gs}$			104	nC
$Q_{gd}$			125	nC
$R_{thJC}$			0.35	$^\circ\text{C/W}$
$R_{thCS}$		0.15		$^\circ\text{C/W}$

Source-Drain Diode		Characteristic Values		
$T_J = 25^\circ\text{C}$ unless otherwise specified)		Min.	Typ.	Max.
$I_S$	$V_{GS} = 0\text{V}$			44 A
$I_{SM}$	Repetitive, pulse width limited by $T_{JM}$			176 A
$V_{SD}$	$I_F = I_S, V_{GS} = 0\text{V}$ , Note 1			1.5 V
$t_{rr}$	$I_F = 22\text{A}, -di/dt = 100\text{A}/\mu\text{s}$ $V_R = 100\text{V}, V_{GS} = 0\text{V}$			300 ns
$Q_{RM}$			2.5	$\mu\text{C}$
$I_{RM}$			17	A

Note 1: Pulse test,  $t \leq 300\mu\text{s}$ ; duty cycle,  $d \leq 2\%$ .

### ISOPLUS i5-Pak™ HV (IXFL) Outline

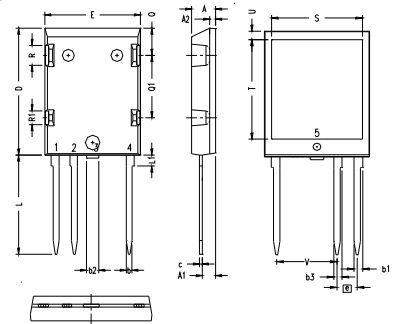

Note: Bottom heatsink meets 2500 Vrms isolation to the other pins.

SYM	INCHES		MILLIMETERS	
	MIN	MAX	MIN	MAX
A	.190	.205	4.83	5.21
A1	.102	.118	2.59	3.00
A2	.046	.055	1.17	1.40
b	.045	.055	1.14	1.40
b1	.063	.072	1.60	1.83
b2	.100	.110	2.54	2.79
b3	.058	.068	1.47	1.73
c	.020	.029	0.51	0.74
D	1.020	1.040	25.91	26.42
E	.770	.799	19.56	20.29
e	.150 BSC		3.81 BSC	
L	.780	.820	19.81	20.83
L1	.080	.102	2.03	2.59
Q	.210	.235	5.33	5.97
Q1	.490	.513	12.45	13.03
R	.150	.180	3.81	4.57
R1	.100	.130	2.54	3.30
S	.668	.690	16.97	17.53
T	.801	.821	20.34	20.85
U	.065	.080	1.65	2.03
V	.440	.460	11.18	11.68

IXYS reserves the right to change limits, test conditions, and dimensions.

IXYS MOSFETs and IGBTs are covered by one or more of the following U.S. patents:	4,835,592	4,931,844	5,049,961	5,237,481	6,162,665	6,404,065 B1	6,683,344	6,727,585	7,005,734 B2	7,157,338B2
	4,850,072	5,017,508	5,063,307	5,381,025	6,259,123 B1	6,534,343	6,710,405 B2	6,759,692	7,063,975 B2	
	4,881,106	5,034,796	5,187,117	5,486,715	6,306,728 B1	6,583,505	6,710,463	6,771,478 B2	7,071,537	

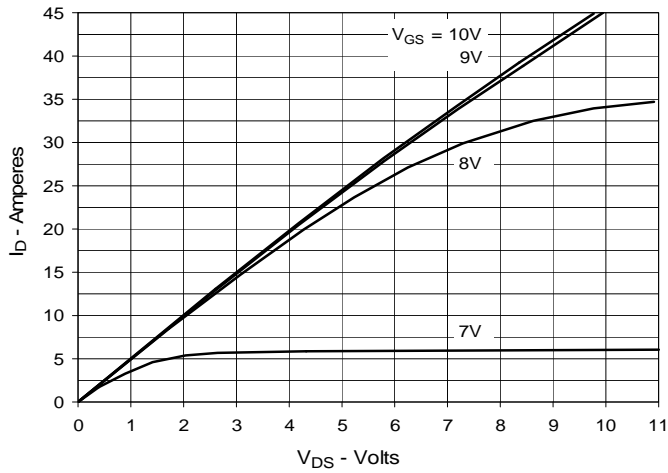
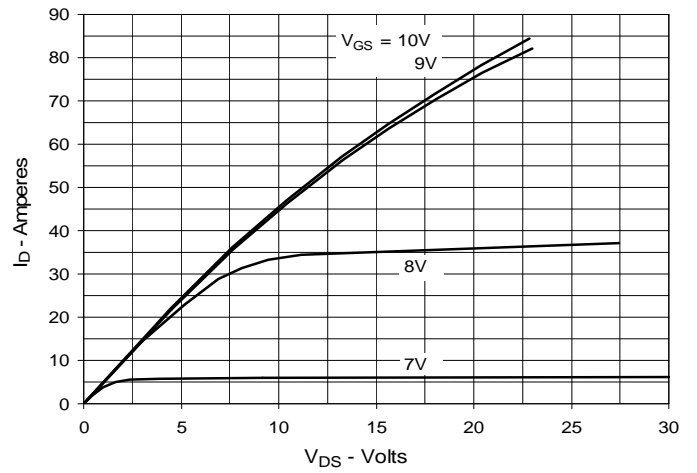
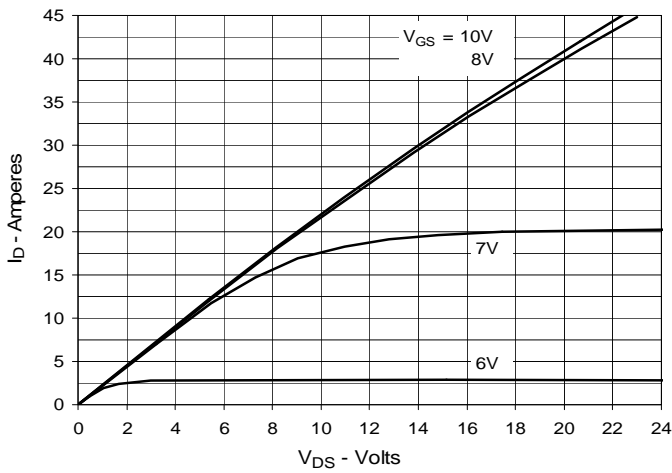
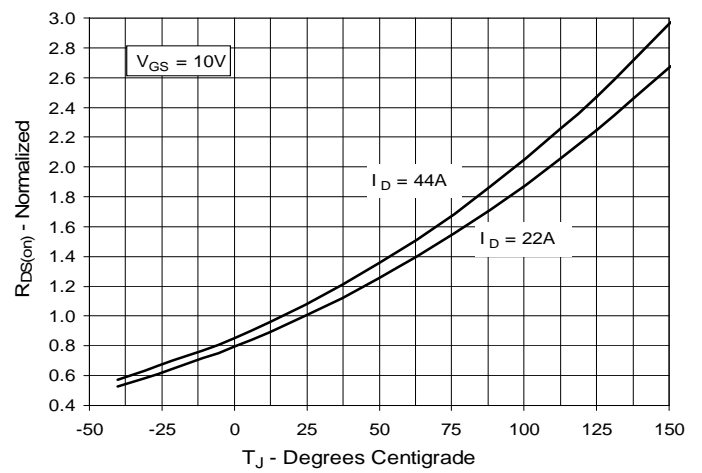
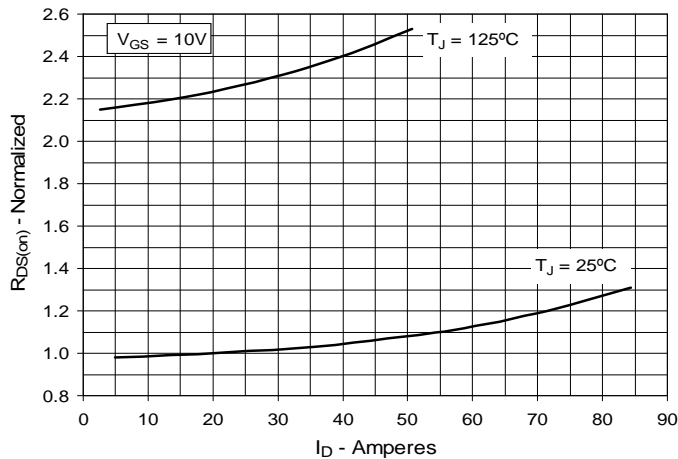
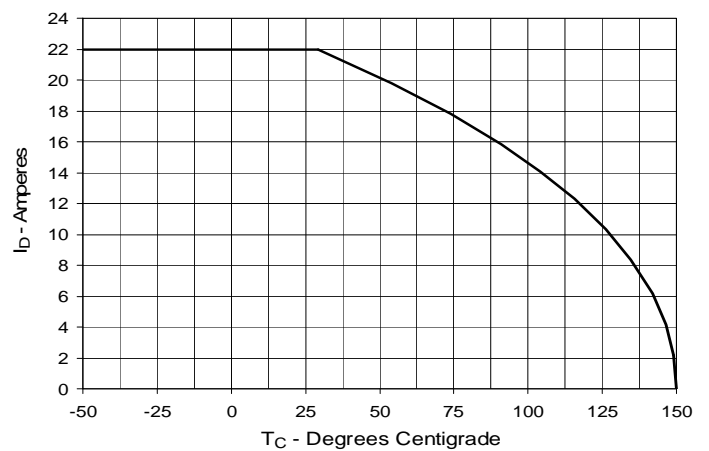
**Fig. 1. Output Characteristics  
@ 25°C**

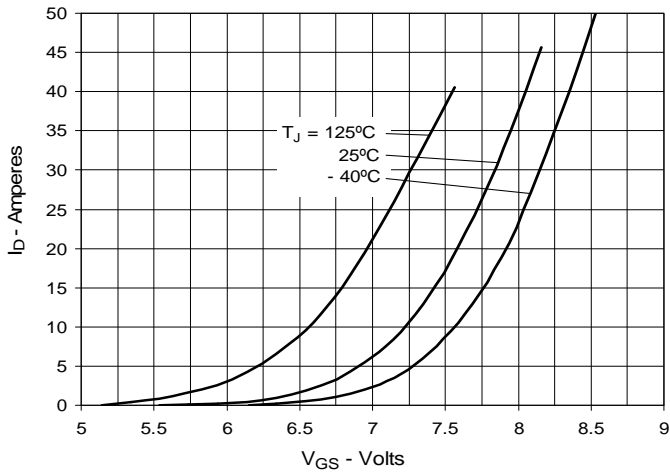
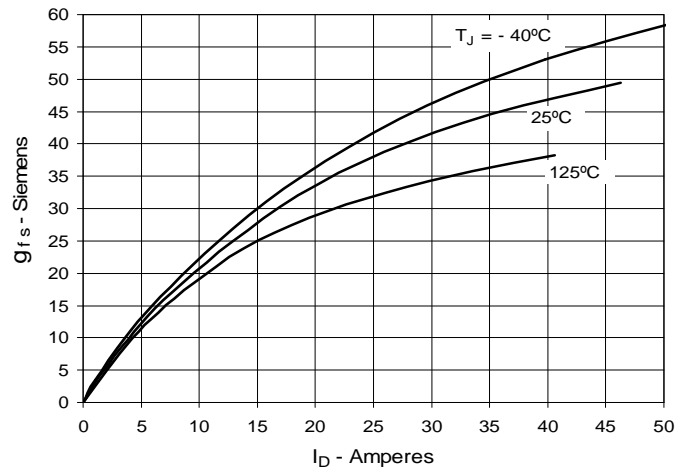
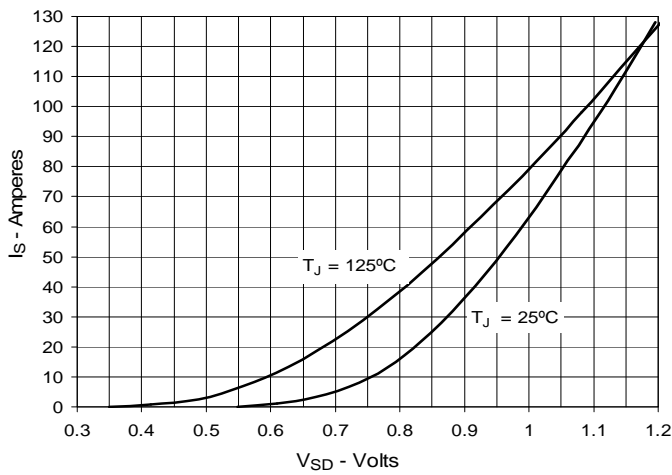
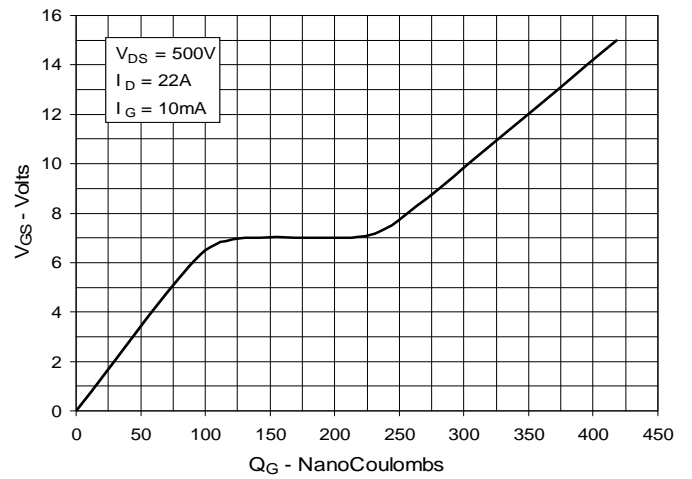
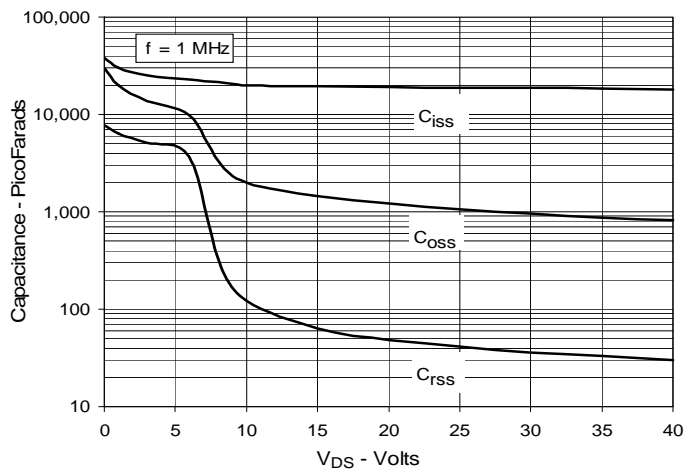
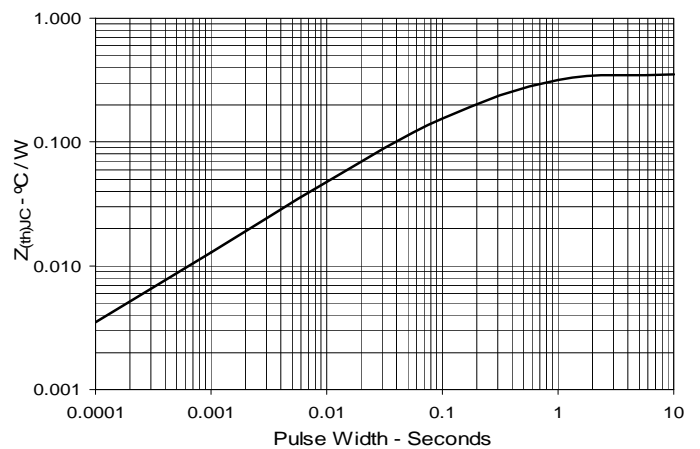
**Fig. 2. Extended Output Characteristics  
@ 25°C**

**Fig. 3. Output Characteristics  
@ 125°C**

**Fig. 4.  $R_{DS(on)}$  Normalized to  $I_D = 22A$  Value  
vs. Junction Temperature**

**Fig. 5.  $R_{DS(on)}$  Normalized to  $I_D = 22A$  Value  
vs. Drain Current**

**Fig. 6. Maximum Drain Current vs.  
Case Temperature**

**Fig. 7. Input Admittance**

**Fig. 8. Transconductance**

**Fig. 9. Forward Voltage Drop of Intrinsic Diode**

**Fig. 10. Gate Charge**

**Fig. 11. Capacitance**

**Fig. 12. Maximum Transient Thermal Impedance**



---

Disclaimer Notice - Information furnished is believed to be accurate and reliable. However, users should independently evaluate the suitability of and test each product selected for their own applications. Littelfuse products are not designed for, and may not be used in, all applications. Read complete Disclaimer Notice at [www.littelfuse.com/disclaimer-electronics](http://www.littelfuse.com/disclaimer-electronics).