

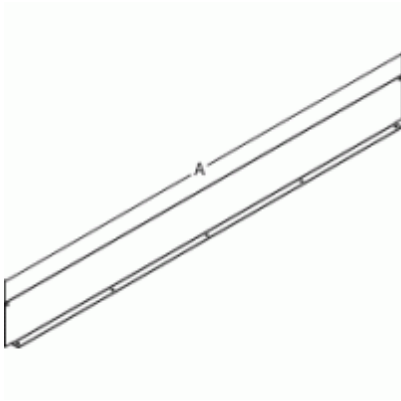

Quality Products. Service Excellence.

Straight Section Barrier *CWBA Series*



Part No.	For use with	L
CWBA260	2.5 x 2.5	58.88
CWBA460	4 x 4	58.88
CWBA660	6 x 6	58.88
CWBA860	8 x 8	58.88

Data subject to change without notice



© 2023. Hammond Manufacturing Ltd. All rights reserved.