

# Murata Products for Automotive

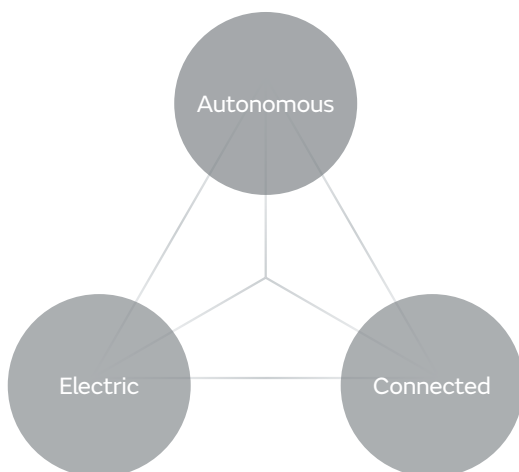

# Realizing a Safe and Free Mobility Society

“CASE”—Connected, Autonomous, Shared & Services, Electric—the four trends occurring in the automobile industry are quickly advancing cars to the next level. Automobiles are undergoing rapid electrification, which enables not only car-to-car communication, but also communication between vehicles and social infrastructure such as traffic lights. This so-called “Vehicle to Everything” (V2X) is in progress, changing automobiles into a highly-sophisticated information devices. In the area of autonomous driving supported by advanced drive assistance system (ADAS), cameras and radars, sensors and other sensing components are required to correctly function under severe conditions to deliver safety. The progress of environmental regulations is also pushing forward the electrification of internal combustion engines. Murata Manufacturing uses its accumulated microfabrication and design technologies, as well as a vertically-integrated production system, to work on product development that responds to the vehicle component market where reliability is a key concern. Murata’s electronic components will continue to contribute to the realization of a mobility society that is safe for everyone.



## Electric

The electrification of automobiles is increasingly expanding the demand for electronic components. Murata delivers products that offer high reliability to respond to the ever-increasing high-performance needs for vehicle parts and components. For example, typical conventional film capacitors for automobiles guarantee operation up to a temperature of 105°C while Murata’s heat-resistant film capacitors enable continuous use in temperature conditions as high as 125°C. Additionally, our self-recovery function in high temperature conditions prevent short-circuit mode failures. Murata’s quality safety functions and guaranteed operations under high temperatures contribute to reliable operation of power electronics systems that operate under high loads.

Applications : Electric Compressor  
OBC (On Board Charger)  
WPT (Wireless Power Transfer System)

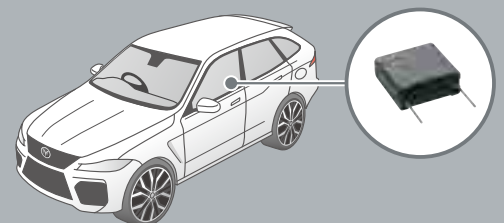



## INDEX

- 03 Enabling Automotive
- 05 Circuit Application
- 17 Specific Use Products Lineup
- 24 Products Lineup (High Reliability)



### Autonomous

While the autonomy level of self-driving functions may vary, all autonomous driving functions need algorithms to comprehensively process precision sensing and retrieved information. In developing ADAS and other products for autonomous driving, Murata conducts driving experiments with test vehicles equipped with our proprietary inertial measurement unit (IMU) for evaluation as part of our efforts to assess and verify safety with different use cases. Murata's product lineup allows for precision instruments, contributing to higher accuracy of measurement data, a keystone for autonomous vehicle driving.

Applications : AD/ADAS

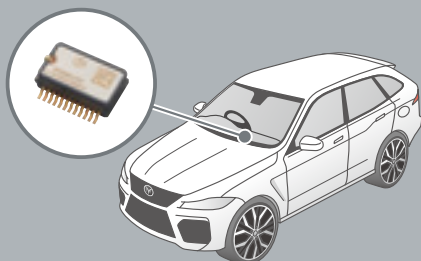

### Connected

Vehicles are using a number of wireless communications standards for V2X, which calls for an increasing demand in electronic parts and components that constitute quality communication networks. Murata also provides highly-functional, durable products to the telecommunications market, including smartphones and base stations. Drawing on our amassed techniques and design knowledge, Murata contributes to sophisticated vehicle communication with our reliable connectivity modules featuring the thermal and vibration resistance that answers the needs of the vehicle component market.

Applications : IVI System

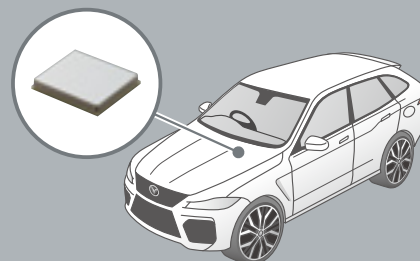

# Enabling Automotive

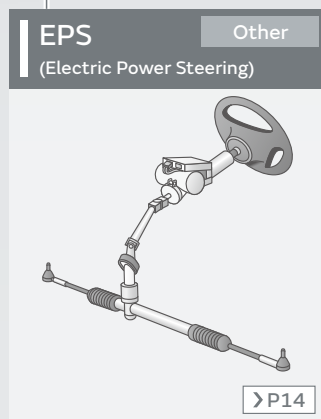
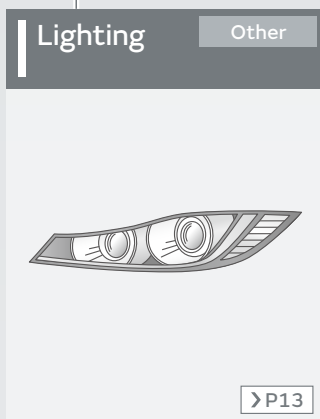
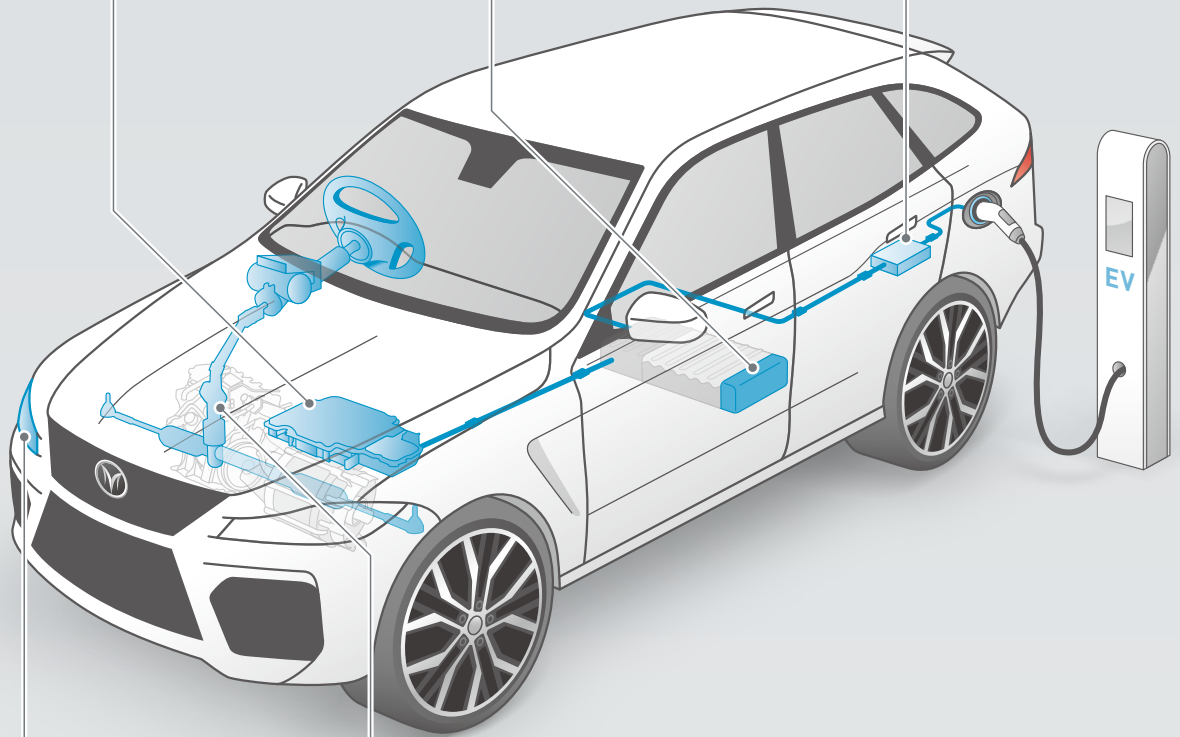
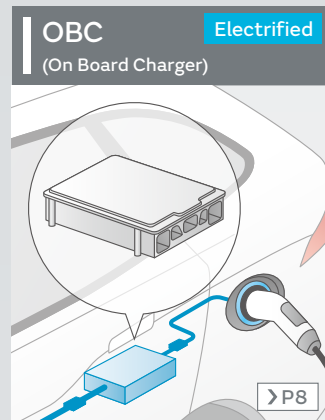
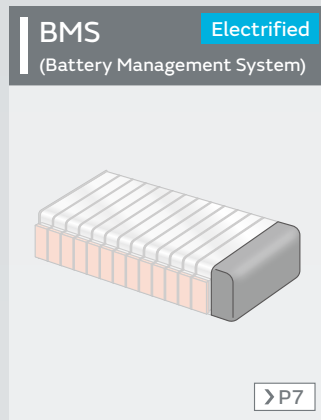
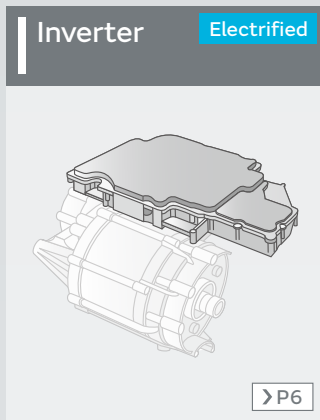

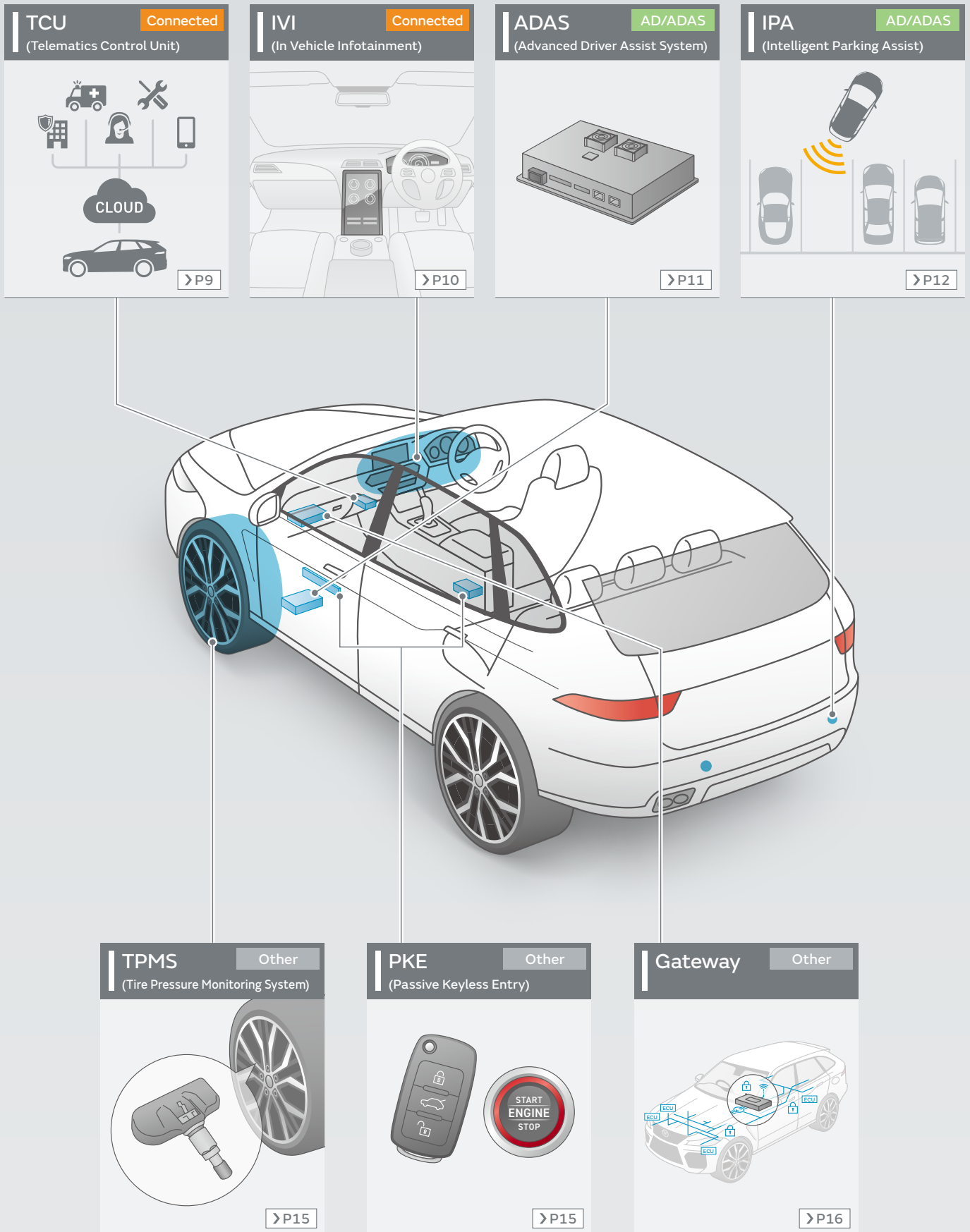

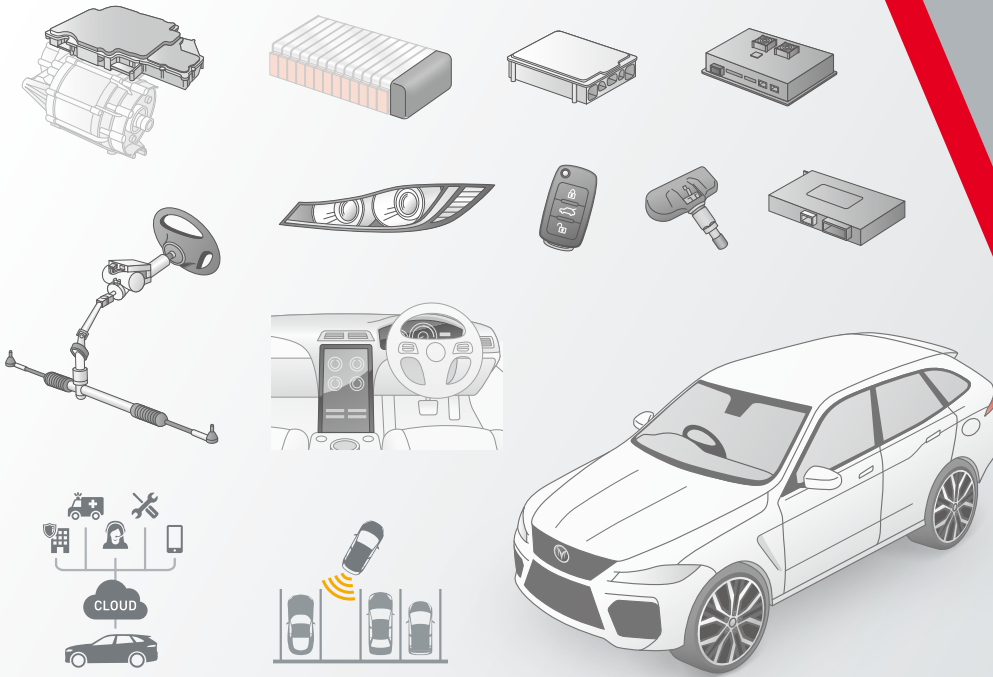

# Circuit Applications

# Inverter

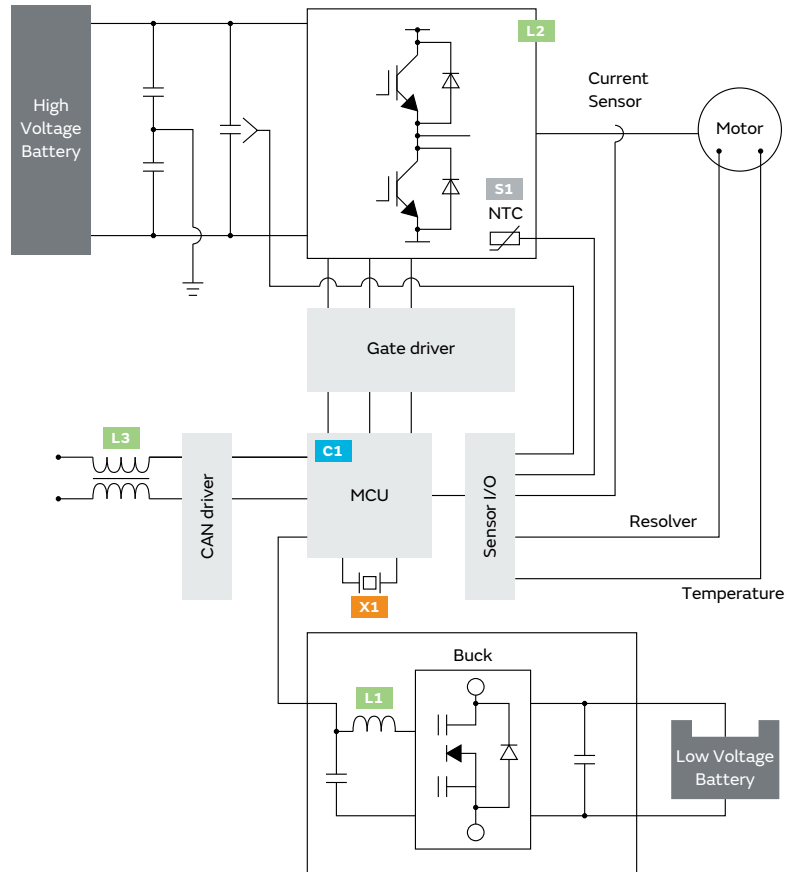
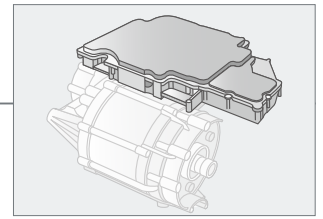

MCU	
<b>C1</b>	Ceramic Capacitors High capacitance type GCM

IGBT	
<b>L2</b>	EMI Suppression Filters Chip ferrite beads BLM
<b>S1</b>	Thermistors NTC thermistors NCU

CAN	
<b>L3</b>	EMI Suppression Filters Common mode choke coils DLW325H/435H

DC-DC	
<b>L1</b>	Inductors Inductor for power lines DFE, LQH

Clock	
<b>X1</b>	Timing Devices Ceramic resonators (CERALOCK) CSTN_G/V

# BMS

## Battery Management System

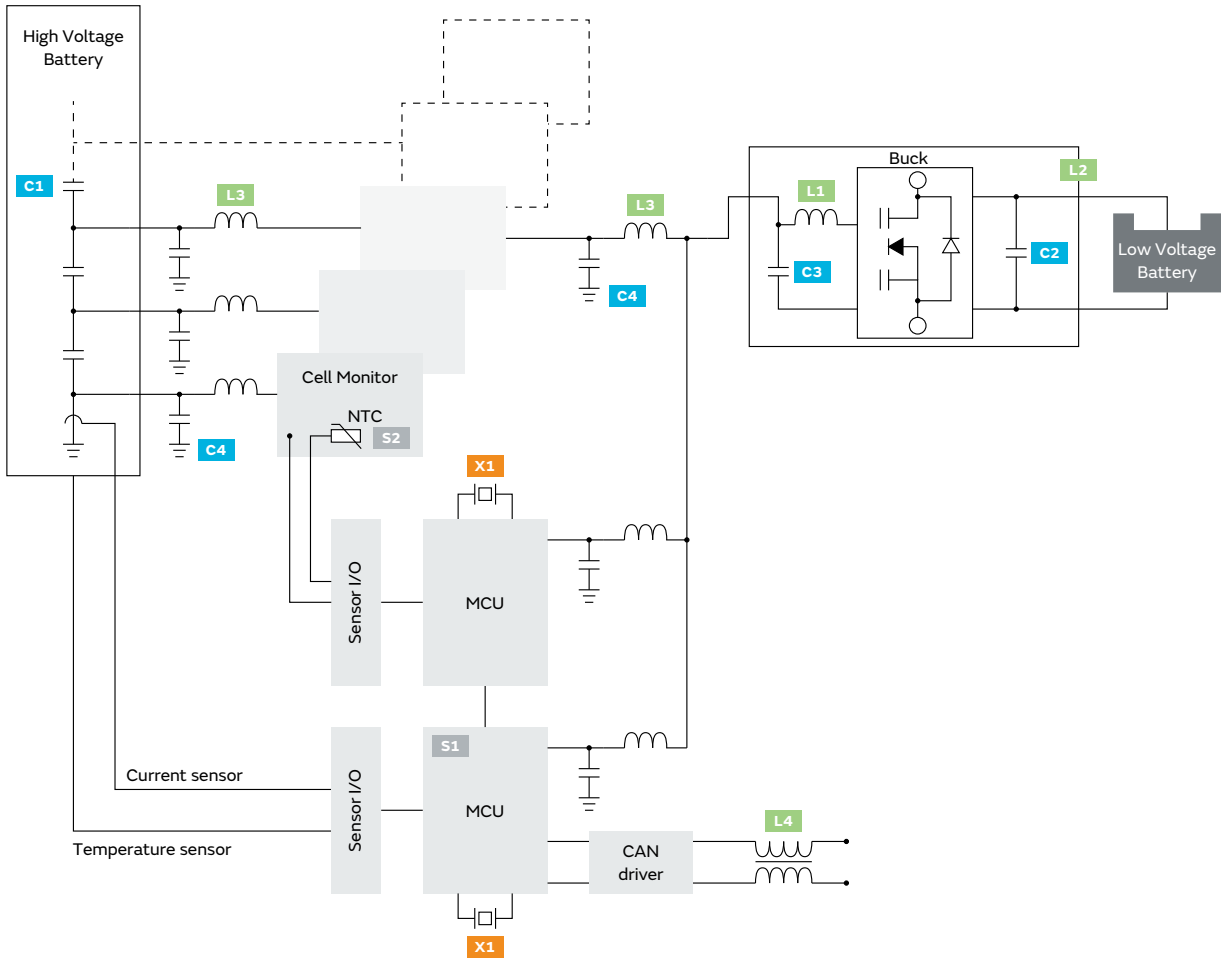
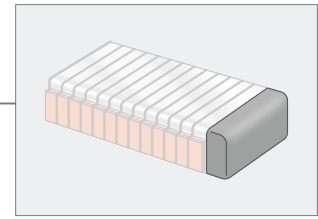

MCU	
S1	Thermistors NTC thermistors NCU

Cell Monitor	
C4	Ceramic Capacitors High capacitance type GCM

L3	EMI Suppression Filters Chip ferrite beads BLM
----	--

S2	Thermistors NTC thermistors NCU, NXFS
----	---

Battery	
C1	Ceramic Capacitors Hi-voltage GCM

DC-DC	
C2	Ceramic Capacitors Resin electrode product/ Metal terminal type GCJ, KC

C2	Ceramic Capacitors High capacitance type GCM
----	--

C3	Ceramic Capacitors High capacitance type GCM
----	--

L1	Inductors Inductor for power lines DFE, LQH
----	---

L2	EMI Suppression Filters Common mode choke coils for power lines PLT, DLW
----	---

CAN	
L4	EMI Suppression Filters Common mode choke coils DLW32SH/43SH

Clock	
X1	Timing Devices Ceramic resonators (CERALOCK) CSTN_G/V



# OBC

## On Board Charger

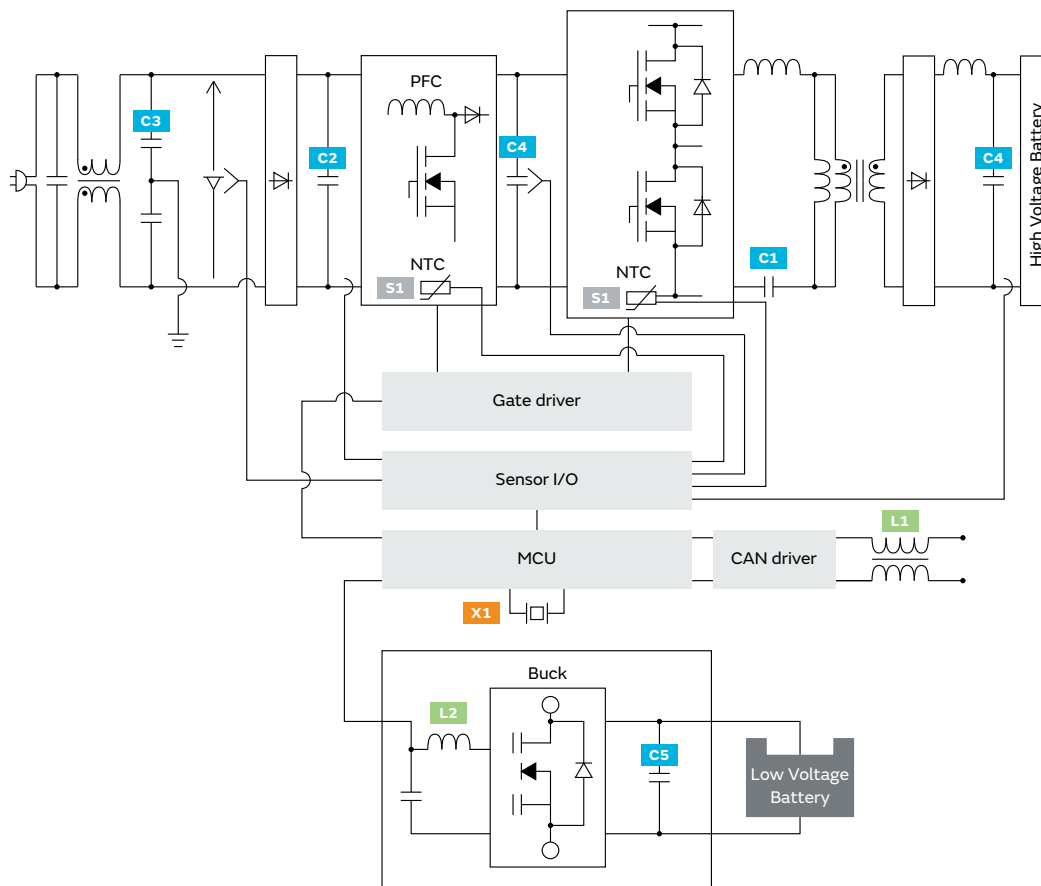
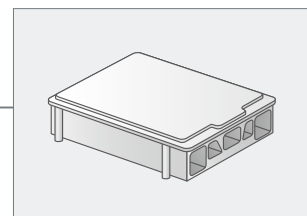

Filter	
<b>C1</b>	Ceramic Capacitors Hi-voltage GCM
<b>C2</b>	Ceramic Capacitors Metal terminal type KC3
AC-DC	
<b>C3</b>	Ceramic Capacitors Safety standard certified KCA, DE6

Smoothing	
<b>C4</b>	Film Capacitors High heat resistant FH
DC-DC	
<b>C5</b>	Ceramic Capacitors Resin electrode product/ Metal terminal type GCJ, KC
<b>L2</b>	Inductors Inductor for power lines DFE, LQH

CAN	
<b>L1</b>	EMI Suppression Filters Common mode choke coils DLW325H/435H
PFC	
<b>S1</b>	Thermistors NTC thermistors NCU
Clock	
<b>X1</b>	Timing Devices Ceramic resonators (CERALOCK) CSTN_G/V

# TCU

## Telematics Control Unit

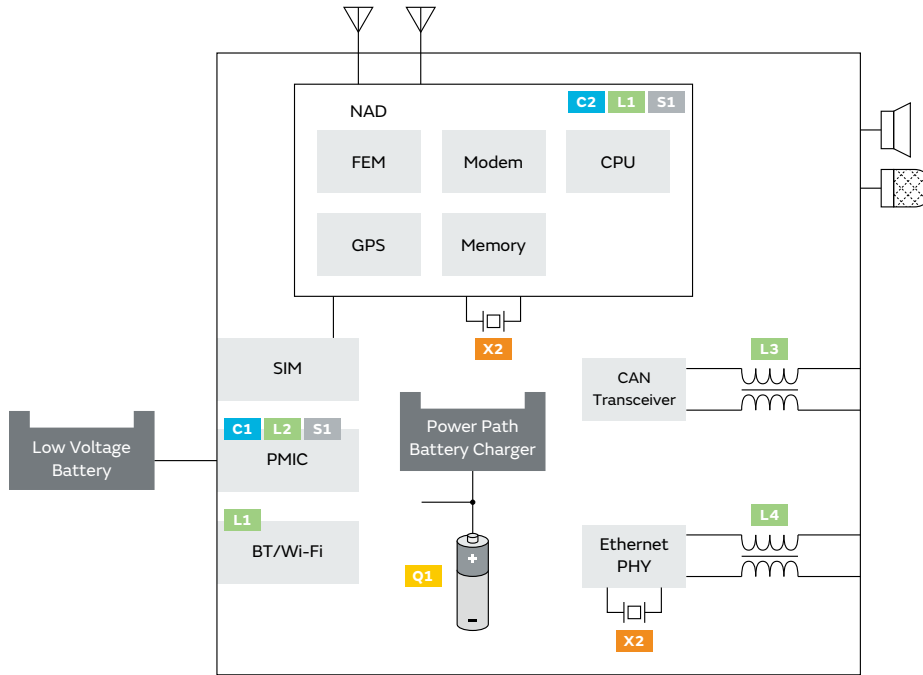
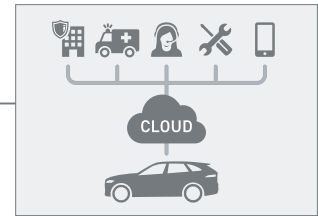

PMIC	
C1	Ceramic Capacitors Resin electrode product/ Metal terminal type GCJ, KC
C1	Ceramic Capacitors High capacitance type GRT
L2	Inductors Inductor for power lines DFE, LQH, LQM
L2	EMI Suppression Filters Chip ferrite beads BLM
S1	Thermistors NTC thermistors NCU
BT/Wi-Fi	
L1	Inductors RF inductors LQP, LQG, LQW

NAD	
C2	Ceramic Capacitors Three terminal type NFM
C2	Ceramic Capacitors High capacitance type GRT
L1	Inductors RF inductors LQP, LQG, LQW
S1	Thermistors NTC thermistors NCU
CAN	
L3	EMI Suppression Filters Common mode choke coils DLW32SH/43SH

Ethernet	
L4	EMI Suppression Filters Common mode choke coils DLW32MH/43MH
e-Call	
Q1	Cylindrical Type Lithium Ion Secondary Batteries Cell type LFP-Gr
Clock	
X2	Timing Devices Crystal units XRC_F_A

# IVI

## In Vehicle Infotainment

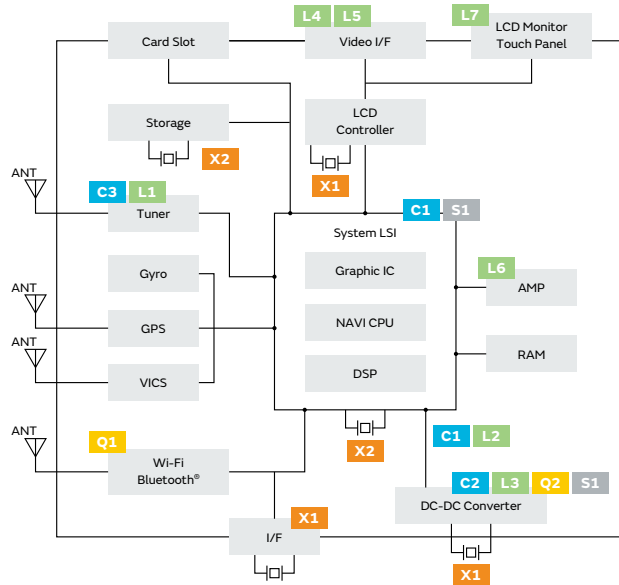
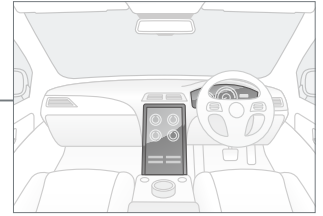

Tuner	
<b>C3</b>	Ceramic Capacitors Hi-Q type GCQ
<b>L1</b>	Inductors RF inductors LQP, LQG, LQW
<b>L1</b>	Inductors Variable inductors 5CCEG

Video I/F	
<b>L4</b>	EMI Suppression Filters Common mode choke coils DLW21SZ
<b>L4</b>	Inductors Inductor for power lines LQW18C/32FT, LQH
<b>L5</b>	EMI Suppression Filters Common mode choke coils DLW32MH/43MH

System LSI	
<b>C1</b>	Ceramic Capacitors Three terminal type NFM
<b>C1</b>	Ceramic Capacitors High capacitance type GRT
<b>C1</b>	Aluminum Electrolytic Capacitors Conductive polymer type ECAS
<b>S1</b>	Thermistors NTC thermistors NCU

I/F	
<b>X1</b>	Timing Devices Ceramic resonators (CERALOCK) CSTN_G/V

AMP	
<b>L6</b>	Inductors Inductor for power lines DFE, FDS, DEM, HEAWS
<b>L6</b>	EMI Suppression Filters Common mode choke coils UCMH, DLW

DC-DC Converter	
<b>C2</b>	Ceramic Capacitors High capacitance type GRT
<b>C2</b>	Aluminum Electrolytic Capacitors Conductive polymer type ECAS
<b>L3</b>	EMI Suppression Filters Common mode choke coils for power lines PLT, UCMH, DLW
<b>L3</b>	EMI Suppression Filters Chip ferrite beads BLM
<b>S1</b>	Thermistors NTC thermistors NCU
<b>Q2</b>	DC-DC Converters MYMG

Secondary	
<b>C1</b>	Ceramic Capacitors Three terminal type NFM
<b>C1</b>	Ceramic Capacitors High capacitance type GRT
<b>C1</b>	Aluminum Electrolytic Capacitors Conductive polymer type ECAS
<b>L2</b>	Inductors Inductor for power lines DFE, LQH, LQM
<b>L2</b>	EMI Suppression Filters Chip ferrite beads BLM

Clock	
<b>X1</b>	Timing Devices Ceramic resonators (CERALOCK) CSTN_G/V
<b>X2</b>	Timing Devices Crystal units XRC_F_A

Connectivity	
<b>Q1</b>	Connectivity Module Wi-Fi and Bluetooth modules

LCD Monitor Touch Panel	
<b>L7</b>	EMI Suppression Filters Chip EMIFIL NFL



# IPA

## Intelligent Parking Assist

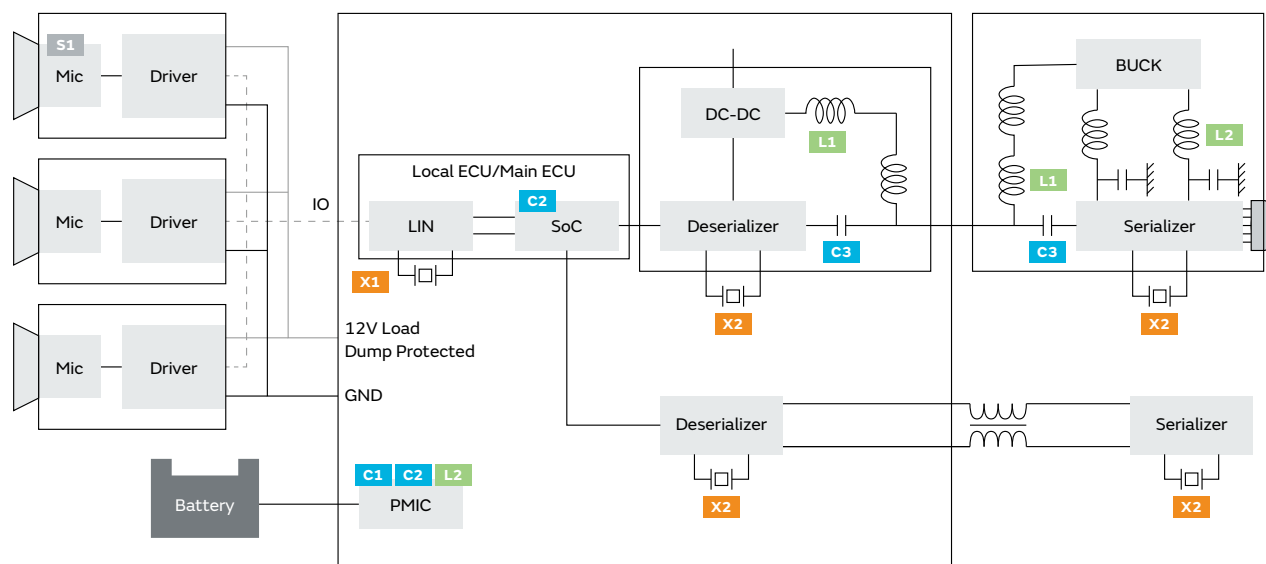

Mic	
S1	Sensors Ultrasonic sensors MA58

PMIC	
C1	Ceramic Capacitors Resin electrode product/ Metal terminal type GCJ, KC
C1	Ceramic Capacitors High capacitance type GCM
C2	Ceramic Capacitors Three terminal type NFM
C2	Ceramic Capacitors High capacitance type GCM
L2	Inductors Inductor for power lines DFE, LQM, LQH

SoC	
C2	Ceramic Capacitors Three terminal type NFM
C2	Ceramic Capacitors High capacitance type GCM

PoC	
C3	Ceramic Capacitors High capacitance type GCM
L1	EMI Suppression Filters Chip ferrite beads BLM
L1	Inductors Inductor for power lines LQW18C/32FT, LQH

DC-DC	
L2	Inductors Inductor for power lines DFE, LQM, LQH

Clock	
X1	Timing Devices Ceramic resonators (CERALOCK) CSTN_G/V
X2	Timing Devices Crystal units XRC_F_A

# Lighting

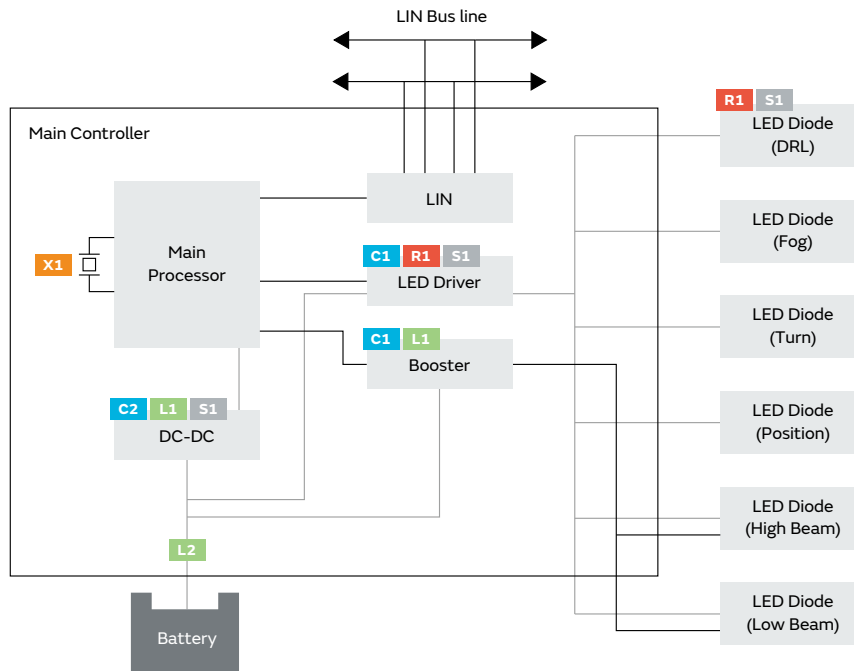
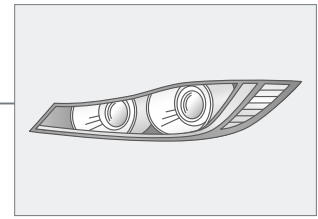

DC-DC	
C2	Ceramic Capacitors Resin electrode product/ Metal terminal type GCJ, KC
C2	Ceramic Capacitors High capacitance type GCM
L1	Inductors Inductor for power lines LQH
S1	Thermistors NTC thermistors NCU

LED Driver	
C1	Ceramic Capacitors High capacitance type GCM
R1	Thermistors PTC thermistors PRF, PRG
S1	Thermistors NTC thermistors NCU

Booster	
C1	Ceramic Capacitors High capacitance type GCM
L1	Inductors Inductor for power lines LQH

LED Diode (DRL)	
R1	Thermistors PTC thermistors PRF, PRG
S1	Thermistors NTC thermistors NCU

Primary	
L2	EMI Suppression Filters Chip ferrite beads BLM
L2	EMI Suppression Filters Common mode choke coils for power lines PLT, DLW

Clock	
X1	Timing Devices Ceramic resonators (CERALOCK) CSTN_G/V

# EPS

## Electric Power Steering

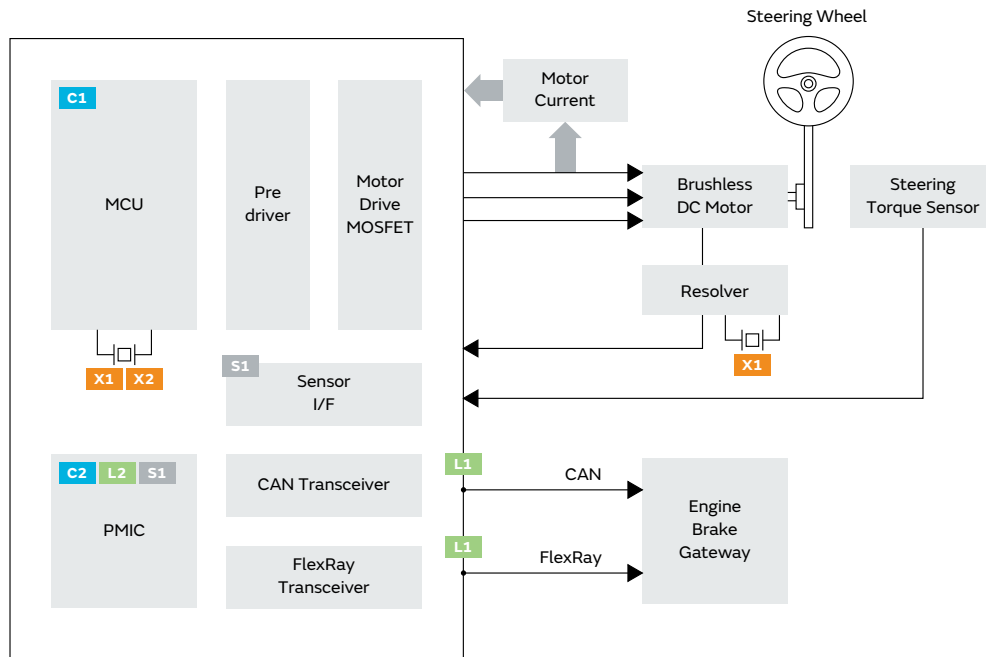
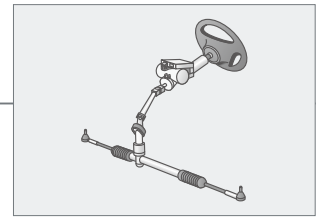

MCU	
<b>C1</b>	Ceramic Capacitors High capacitance type GCM

Clock	
<b>X1</b>	Timing Devices Ceramic resonators (CERALOCK) CSTN_G/V

<b>X2</b>	Timing Devices Crystal units XRC_F_A
-----------	--

PMIC	
<b>C2</b>	Ceramic Capacitors Resin electrode product/ Metal terminal type GCJ, KC

<b>C2</b>	Ceramic Capacitors High capacitance type GCM
-----------	--

<b>L2</b>	EMI Suppression Filters Chip ferrite beads BLM
-----------	--

<b>S1</b>	Thermistors NTC thermistors NCU
-----------	---------------------------------------

PHY	
<b>L1</b>	EMI Suppression Filters Common mode choke coils DLW32SH/43SH

Sensor I/F	
<b>S1</b>	Thermistors NTC thermistors NCU

# PKE / TPMS

## Passive Keyless Entry / Tire Pressure Monitoring System

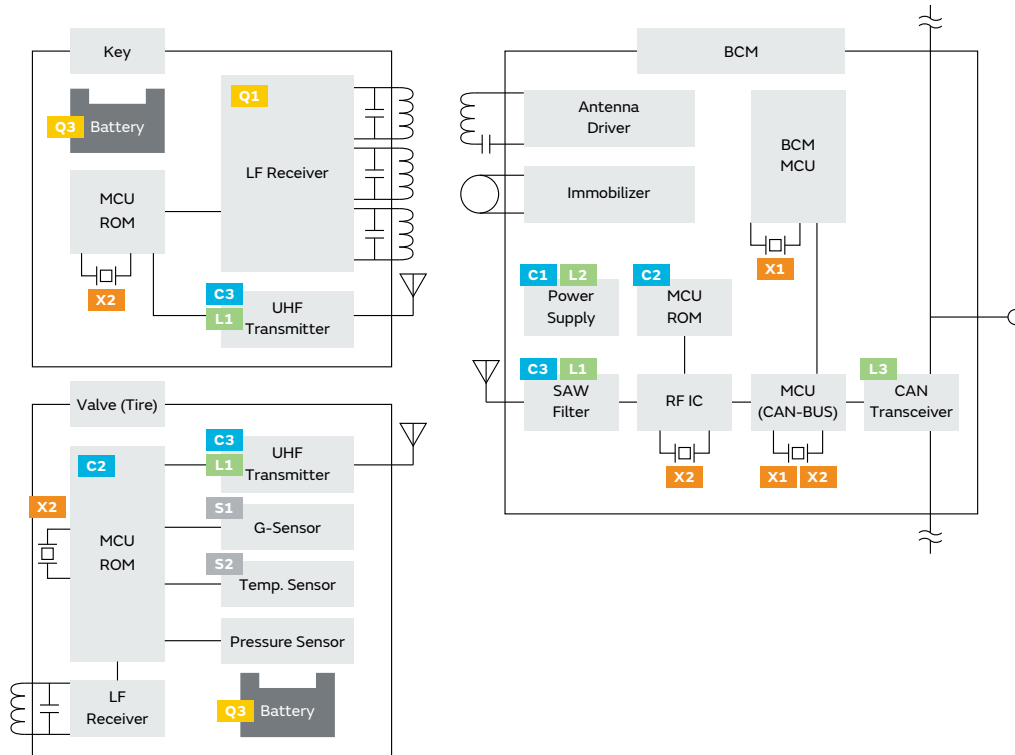
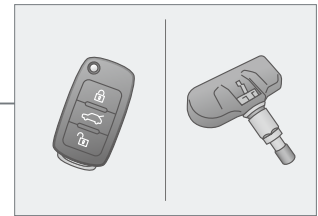

**Battery**

Q3 Micro Batteries

**LF Receiver**

Q1 Antenna Coils  
3d Rx-LF antenna coils  
SA3D12, SA3D14

**UHF Transmitter**

C3 Ceramic Capacitors  
Hi-Q type  
GCQ

L1 Inductors  
RF inductors  
LQP, LQG, LQW

**MCU ROM**

C2 Ceramic Capacitors  
High capacitance type  
GCM

**G-Sensor**

S1 Sensors  
Shock sensors  
PKGS

**Temp. Sensor**

S2 Thermistors  
NTC thermistors  
NCU

**Power Supply**

C1 Ceramic Capacitors  
Resin electrode product/  
Metal terminal type  
GCJ, KC

C1 Ceramic Capacitors  
High capacitance type  
GCM

L2 Inductors  
Inductor for power lines  
DFE□PD

L2 Inductors  
Inductor for power lines  
LQH\_P, LQM\_P

L2 EMI Suppression Filters  
Chip ferrite beads  
BLM\_P

**SAW Filter**

C3 Ceramic Capacitors  
Hi-Q type  
GCQ

L1 Inductors  
RF inductors  
LQP, LQG, LQW

**CAN Transceiver**

L3 EMI Suppression Filters  
Common mode choke coils  
DLW325H/435H

**Clock**

X1 Timing Devices  
Ceramic resonators  
(CERALOCK)  
CSTN\_G/V

X2 Timing Devices  
Crystal units  
XRC\_F\_A



# Gateway / In-vehicle LAN

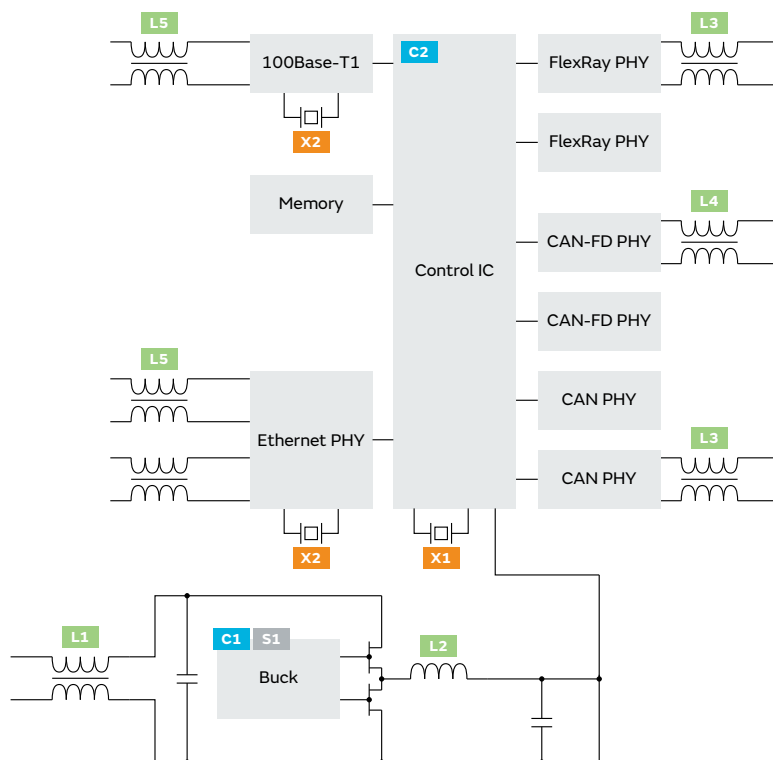
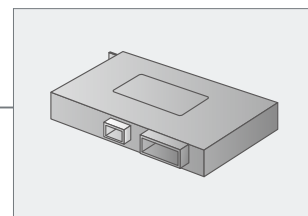

DC-DC	
<b>C1</b>	Ceramic Capacitors Resin electrode product/ Metal terminal type GCJ, KC
<b>C1</b>	Ceramic Capacitors High capacitance type GCM
<b>L1</b>	EMI Suppression Filters Common mode choke coils for power lines PLT, DLW
<b>L2</b>	Inductors Inductor for power lines DFE, LQH, LQM
<b>S1</b>	Thermistors NTC thermistors NCU

Control IC	
<b>C2</b>	Ceramic Capacitors High capacitance type GCM
<b>C2</b>	Ceramic Capacitors Three terminal type NFM
PHY	
<b>L3</b>	EMI Suppression Filters Common mode choke coils DLW32SH/43SH
<b>L4</b>	EMI Suppression Filters Common mode choke coils DLW32SH/43SH

OBD	
<b>L5</b>	EMI Suppression Filters Common mode choke coils DLW32MH/43MH
Clock	
<b>X1</b>	Timing Devices Ceramic resonators (CERALOCK) CSTN_G/V
<b>X2</b>	Timing Devices Crystal units XRC_F_A



# Specific Use Products Lineup

Specific Use Products Lineup

# RF Components

## Connectivity Modules

This product is an integrated module that encompasses various functional parts used in vehicle wireless circuits for Bluetooth and Wi-Fi.

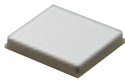

## Chip Multilayer LC Filters

Ultra-small and low-profile filters based on ceramic multilayer technology.

### Band Pass Filters

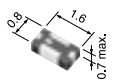

LFB18\_V Series

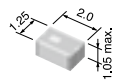

LFB21\_V Series

(in mm)

### Low Pass Filters

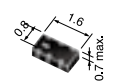

LFL18\_V Series

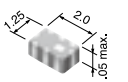

LFL21\_V Series

(in mm)

## Baluns

SMD baluns constructed with a copper conductor and ceramic material. Ideal for high-frequency applications. Small size and low-loss baluns can be customized for balance impedance of 50Ω to 200Ω.

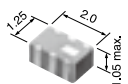

LDB21\_V Series

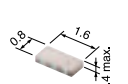

LDM18\_V Series

(in mm)

## Chip Multilayer Hybrid Dividers

Power divider with a multilayer low pass filter in an ultra-compact package.

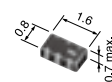

LDD18\_V Series

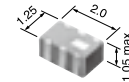

LDD21\_V Series

(in mm)

## Couplers

An ultra-small, low-profile directional coupler based on ceramic multilayer technology. This coupler achieves ultra-small size, low insertion loss, and high isolation.

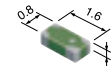

LDC18\_V Series



LDC21\_V Series

(in mm)

## Antenna Coils

This highly reliable antenna coil for transponders which conforms to automotive standards is ideal for automobile keyless entry.

### Rx 3D-ANT



SA3D12 Series

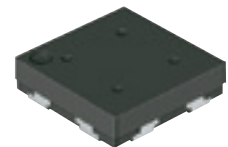

SA3D14 Series

Series	Test Frequency (kHz)	Dimensions (mm)	Inductance Range (mH)
SA3D12	125/134.2	11.9 X 11.9 X 3.2 Typ.	X : 2.2 to 6.3
			Y : 2.2 to 6.3
			Z : 2.2 to 9.0
SA3D14	125/134.2	13.8 X 13.8 X 3.6 Typ.	X : 2.2 to 6.3
			Y : 2.2 to 6.3
			Z : 2.2 to 9.0

## Specific Use Products Lineup

## Sensors

## Ultrasonic sensors

Ultrasonic sensors emit ultrasonic waves in the air that reflect off of objects.

The reflected sound is then received by the sensor. This technology is used for detection of objects in burglar alarms and automatic doors as well as for range measurement in automotive parking assistance systems.



Part Number	Type	Using Method	Nominal Frequency (kHz)	Overall Sensitivity (V0-p)	Directivity (deg.)	Dimensions (mm)
MA58MF14-7N	Drip Proof Type	For Dual Use	58	More than 1	80 X 34 typ.	ø14

## Shock sensors

To reduce the TPMS module's battery consumption, it detects the tires' rotational speed and uses a shock sensor to wake up the system.



Part Number	Primary Axis Inclined Angle (deg.)	G Sensitivity	Insulation Resistance (MΩ)	Resonance Frequency (kHz)	Capacitance (pF)	Operating Temperature Range (°C)	Dimensions (mm)
PKGS-25TA-R	25	0.205pC/G	500 min.	39 typ.	240	-40 to +125	4.8 X 2.3 X 1.3
PKGS-00TAV-R	0	0.80mV/G	500 min.	39 typ.	245		
PKGS-45TAV-R1	45	0.77mV/G	500 min.	37 typ.	195		

## Gyro Sensors

The high-sensitivity low-g accelerometers and gyroscope sensors are widely used in the automotive area.

## Gyro Sensors



Series	Axis	Maximum Range	Supply Voltage (V)	Operating Temperature Range (°C)	Sensitivity	Amplitude Response (Hz)	Output Type	Typical Applications
SCC2000 Series	1-Axis (X or Z) Gyro	±125dps / ±300dps	3.0 to 3.6	-40 to +125	50 LSB/dps (Gyro)	10/60 (Gyro)	SPI	Electronic Stability Control Roll Over detection Navigation system Advanced Driving Assistant System (ADAS) Inertial Measurement Units (IMUs) Platform stabilization and control Machine control systems Hill Start Assist (HSA)
	3-Axis Accelerometer	±2g / ±6g			1962 LSB/g (Accelerometer)	10/60 (Accelerometer)		

## Accelerometers



Series	Axis	Maximum Range (g)	Supply Voltage (V)	Operating Temperature Range (°C)	Sensitivity (count/g)	Amplitude Response (Hz)	Output Type	Typical Applications
SCA800	1-axis	±2	3.0 to 3.6	-40 to +125	900	6.25, 50	SPI	Headlight leveling Lidar leveling Transmission control Electronic stability control Hill Start Assist (HSA) IMUs for heavy machine & automotive
SCA3100	3-Axis	±2 ±6	3.0 to 3.6	-40 to +125	900 650	45	SPI	
SCA3300	3-Axis	±1.5, ±3, ±6 User Selectable	3.0 to 3.6	-40 to +125	5400/2700/ 1350	70/10	SPI	

## Specific Use Products Lineup



## Power Devices

## DC-DC Converters

Murata Manufacturing's the surface mounted type point-of-load (PoL) DC-DC converter for camera module integrates component parts with plastic.

The MYPMA series is a non-isolated DC-DC converter for auxiliary circuits used on E-motorcycles and forklifts.

This series features a lightweight, compact palm-size design and meets IP56 protection (dust-proof and waterproof).

Series		Output Current (A)	Input Voltage (V)	Output Voltage (V)	Dimensions (mm)			Efficiency (%)
					W	L	H (max.)	
 MYMGA/MYMGK	MYMGA5R04RELA5RA	4	8 to 16	3.3 to 5.0	10.5	9	5.5	94 (12Vin/5Vo)
	MYMGK00504ERSR	4	8 to 15	0.7 to 5	9	7.5	5	96.1 (12Vin/5Vo)
 MYMGC	MYMGC0R88RFLF2RV	8	3.3 to 5.5	0.85	15	11.9	2.4	81 (5Vin)
	MYMGC1R83BFPF2RV (4 outputs product)	3.2	3.3 to 5.5	0.85	15	11.9	2.4	81 (5Vin)
		0.5		0.85				
		0.5		1.2				
		1.5		1.8				
	MYMGC3R32EFPF2RV (4 outputs product)	2.5	4.3 to 5.5	1.2	15	11.9	2.4	91 (5Vin)
		1		1.8				
2		3.3						
	1.5		2.5					
 MYPMA	MYPMA01218RCF-CAB	10	36 to 75	12	86.5	122.36*	35.85	96.5peak (48Vin)
	MYPMA01218RCF-CCB	10	36 to 75	12	86.5	122.36*	35.85	96peak (48Vin)
		1		5				

\*Not including the lengths of the wire and connector.

# Batteries

## Cylindrical Type Lithium Ion Secondary Batteries

Cylindrical type lithium ion secondary batteries are packaged in metal cans. These batteries has a long life with a high level of safety.

Model	Cell Type	Dimensions (mm)	Rated Capacity (mAh)	Continuous Maximum Discharging Current (A)	Average Voltage (V)	Operating Temperature Range (°C)
US14500FT1	LFP-Gr	14.00 X 49.10	500	5.0	3.2	-40 to +90
US18650FTC1	LFP-Gr	18.20 X 64.90	1050	20.0	3.2	-40 to +90
US18650FTC2	LFP-Gr	18.35 X 65.05	1350	20.0	3.2	-40 to +90
US26650FTC1A	LFP-Gr	26.25 X 65.50	2850	25.0	3.2	-20 to +60

## Coin Manganese Dioxide Lithium Batteries

The coin-type lithium manganese dioxide battery (CR battery) is a small, primary battery that uses manganese dioxide on the positive side and lithium on the negative side. It is used in a wide variety of applications, including IoT device and automotive devices of tire-pressure monitoring systems (TPMS) and smart entry systems.

### Heat-resistant

Ideal for devices used in severe operating temperature environments including automobiles and FA, etc.



CR2050W-MP6

Model	Electrical Characteristics			Dimensions			Operating Temperature Range (°C)
	Nominal Voltage (V)	Nominal Capacity (mAh)	Recommended Continuous Discharge Current (mA)	Diameter (mm)	Height (mm)	Weight (g)	
CR2032W	3	210	≤1	20.0	3.2	3.1	-40 to +125
CR2050W	3	345	≤1	20.0	5.0	4.2	-40 to +125
CR2450W	3	550	≤1	24.5	5.0	6.7	-40 to +125
CR2477W	3	1000	≤1	24.5	7.7	11	-40 to +125

## Extended Temperature

Designed for automotive devices and outdoor IoT systems, including smart meters and FA control systems. Recommended as an alternative smaller and thinner solution to conventional cylindrical lithium batteries.



CR2032X-HE1

Model	Electrical Characteristics				Dimensions			Operating Temperature Range (°C)
	Nominal Voltage (V)	Nominal Capacity (mAh)	Recommended Continuous Discharge Current (mA)	Maximum Pulse Discharge Current*1 (mA)	Diameter (mm)	Height (mm)	Weight (g)	
CR2032X	3.0	220	≤1	30	20.0	3.2	3.0	-40 to +85
CR2450X	3.0	600	≤1	30	24.5	5.0	6.2	-40 to +85
CR2477X	3.0	1000	≤1	30	24.5	7.7	9.5	-40 to +85
CR3677X*2	3.0	2000	≤1	80	36.5	7.7	20	-40 to +85

\*1 Current for maintaining minimum 2V voltage with pulsed discharge of 3 seconds and 50% nominal capacity discharged (ambient temperature 23°C)

\*2 Shipment of mass-produced CR3677X is scheduled to start at the end of 2019.

## High Drain

Ideal for tracking devices for logistics and asset management by adopting Low Power Wide Area (LPWA) networks such as LoRa and SIGFOX as well as for outdoor infrastructures, FA control systems, and environment monitoring sensors.



CR2450R-HO5

Model	Electrical Characteristics				Dimensions			Operating Temperature Range (°C)
	Nominal Voltage (V)	Nominal Capacity (mAh)	Recommended Continuous Discharge Current (mA)	Maximum Pulse Discharge Current*1 (mA)	Diameter (mm)	Height (mm)	Weight (g)	
CR2032R	3.0	200	≤3	50	20.0	3.2	3.0	-30 to +70
CR2450R	3.0	500	≤3	50	24.5	5.0	6.2	-30 to +70

\*1 Current for maintaining minimum 2V voltage with pulsed discharge of 3 seconds and 50% nominal capacity discharged (ambient temperature 23°C)

## Silicon Capacitors

### Automotive high temperature Si capacitors up to 200°C (ATSC)

Series	Capacitance	Dimensions (mm)	Thickness (μm)	Breakdown Voltage (V)	Recommended Voltage* (V)
 ATSC	1nF	0.65 X 0.65	250	30	16
	10nF	0.65 X 0.65	250	30	16
	47nF	1.32 X 1.32	250	30	16
	100nF	1.59 X 1.32	250	30	16

\*Values are based on 10 years of intrinsic life-time prediction at 100°C continuous operation.

### Ultra large-band wire-bondable vertical Si capacitors up to 26GHz+ (UWSC)

Series	Capacitance	Dimensions (mm)	Thickness (μm)	Breakdown Voltage (V)	Recommended Voltage* (V)
 UWSC	100pF	0.25 X 0.25	100	150	68
	100pF	0.5 X 0.5	100	150	68
	100pF	0.5 X 0.5	250	150	68
	150pF	0.381 X 0.381	100	150	68
	1nF	0.5 X 0.5	100	150	68
	1nF	0.5 X 0.5	250	150	68

\*Values are based on 10 years of intrinsic life-time prediction at 100°C continuous operation.

## Wire-bondable Vertical Si Capacitors up to 250°C (WBSC)

Series		Capacitance	Dimensions (mm)	Thickness (μm)	Breakdown Voltage (V)	Recommended Voltage* (V)
 WBSC	WBSC	100pF	0.5 X 0.5	250	150	68
		1nF	0.5 X 0.5	250	150	68
		2.7nF	0.5 X 1.25	250	150	68
		3.7nF	0.5 X 1.625	250	150	68
		4.7nF	0.5 X 2.0	250	150	68

\*Values are based on 10 years of intrinsic life-time prediction at 100°C continuous operation.

## Wire-bondable vertical low-profile Si capacitors down to 100μm (WLSC)

Series		Capacitance	Dimensions (mm)	Thickness (μm)	Breakdown Voltage (V)	Recommended Voltage* (V)
 WLSC	WLSC	100pF	0.25 X 0.25	100	150	68
		100pF	0.5 X 0.5	100	150	68
		150pF	0.381 X 0.381	100	150	68
		470pF	0.8 X 0.5	100	450	198
		1nF	0.5 X 0.5	100	150	68
		2.7nF	0.5 X 1.25	100	150	68
		3.7nF	0.5 X 1.625	100	150	68
		4.7nF	0.5 X 2.0	100	150	68

\*Values are based on 10 years of intrinsic life-time prediction at 100°C continuous operation.

## Film Capacitors



### Specifications

Items	Basic Specifications
Rated Capacitance	10, 15, 20μF
Rated Voltage	500V
Operational Life	125°C/500V 2000h
Biased Humidity	85°C/85%RH/500V 1000h

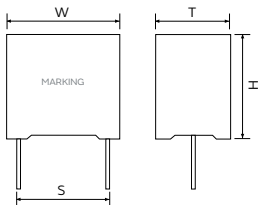

### Dimensions

Part Number	Capacitance (μF)	Dimensions (mm)			
		W	H	T	S
FHA50Y206KS	20	35.0	37.0	20.0	29.0
FHA50Y156KS	15	35.0	35.5	14.5	29.0
FHA50Y106KS	10	35.0	35.5	14.5	29.0



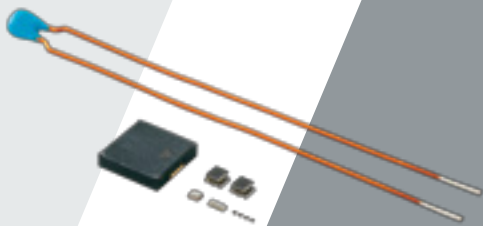

# Products Lineup (High Reliability)

Products Lineup (High Reliability)

# Capacitors

## Icons

	<p><b>Infotainment</b> Infotainment for automotive Products for entertainment equipment like car navigation, car audio, and body control equipment like wipers and power windows.</p>
	<p><b>Powertrain</b> Powertrain/Safety for automotive Products used for applications (running, turning, stopping, and safety devices) that particularly concern human life, such as in devices for automotive.</p>
	<p><b>AEC-Q200</b> AEC-Q200 compliant product</p>
	<p><b>Safety standard</b> Products that acquired safety standard certification IEC60384-14.</p>
	<p><b>High Q</b> Low dissipation for high frequency By devising ceramic materials and electrode materials, low dissipation is achieved in frequency bands of VHF, UHF, and microwave or beyond.</p>
	<p><b>Low ESL</b> Low inductance This capacitor is designed so that the parasitic inductance component (ESL) that the capacitor has on the high frequency side becomes lower.</p>
	<p><b>Deflecting crack</b> Product resistant to deflection cracking This capacitor is designed to prevent failures as much as possible by short mode caused by cracking when there is board deflection.</p>
	<p><b>Soldering crack</b> Product with solder cracking suppression This capacitor is configured with metal terminals and leads connected to the chip. The metal terminals and leads relieve the stress from expansion and contraction of the solder, to suppress solder cracking.</p>
	<p><b>Anti-noise</b> Product suitable for acoustic noise reduction and low distortion This product suppresses acoustic noise, which occurs when a ceramic capacitor is used, by devising the materials and configuration.</p>
	<p><b>EMI Filter</b> Low-inductance product suitable for noise suppression This product has extremely low ESL and is suitable for suppression of noise, including high frequencies.</p>
	<p><b>Limited to conductive glue mounting</b> Limited to conductive glue mounting Since silver palladium is used for the external electrodes, the capacitor can be mounted by conductive adhesive.</p>

## Ceramic Capacitors SMD Type for Automotive

### AEC-Q200 Compliant Chip Multilayer Ceramic Capacitors for Infotainment



#### Temperature Compensating Type

Series	LXW (mm) <Size Code (inch)>	Rated Voltage (Vdc)	Capacitance Range	
 GRT	GRT03	100	1.0pF to 100pF	
		50	1.0pF to 220pF	
		25	1.0pF to 1000pF	
	GRT15	1.0 X 0.5 <0402>	100	1.0pF to 100pF
			50	1.0pF to 1000pF
			25	10pF to 1000pF
	GRT18	1.6 X 0.8 <0603>	100	120pF to 1500pF
			50	1200pF to 10000pF
			25	1200pF to 10000pF
	GRT21	2.0 X 1.25 <0805>	100	1800pF to 3300pF
			50	18000pF to 22000pF
			25	1800pF to 2200pF
GRT31	3.2 X 1.6 <1206>	100	3900pF to 22000pF	
		50	56000pF to 0.10μF	
		25	0.10μF to 0.12μF	
		16	0.12μF	

#### High Dielectric Constant Type

Series	LXW (mm) <Size Code (inch)>	Rated Voltage (Vdc)	Capacitance Range
 GRT	GRT03	35	0.10μF
		25	100pF to 0.10μF
		16	10000pF to 0.10μF
		10	1500pF to 1.0μF
		6.3	2200pF to 1.0μF
		4	68000pF to 1.0μF
		2.5	1.0μF
	GRT15	50	220pF to 0.10μF
		35	0.22μF to 1.0μF
		25	10000pF to 2.2μF
		16	10000pF to 2.2μF
		10	0.22μF to 4.7μF
		6.3	22000pF to 4.7μF
		4	1.0μF to 4.7μF
	GRT18	2.5	10μF
		100	3300pF to 10000pF
		50	1.0μF to 2.2μF
		35	1.0μF to 4.7μF
		25	0.15μF to 10μF
		16	0.33μF to 10μF
		10	10μF to 22μF
		6.3	10μF to 22μF
		4	1.0μF to 22μF
		2.5	22μF

Series		LXW (mm) <Size Code (inch)>	Rated Voltage (Vdc)	Capacitance Range
 GRT	GRT21	2.0 X 1.25 <0805>	100	47000pF
			50	0.47μF to 4.7μF
			35	4.7μF
			25	2.2μF to 22μF
			16	2.2μF to 22μF
			10	3.3μF to 22μF
			6.3	3.3μF to 47μF
			4	47μF
	GRT31	3.2 X 1.6 <1206>	50	1.0μF to 10μF
			35	10μF
			25	1.5μF to 10μF
			16	1.5μF to 22μF
			10	47μF
			6.3	15μF to 47μF
	GRT32	3.2 X 2.5 <1210>	50	3.3μF to 4.7μF
25			6.8μF	
16			47μF	
10			47μF	
6.3			33μF to 100μF	

## Chip Multilayer Ceramic Capacitors for Automotive

### Temperature Compensating Type



Series		LXW (mm) <Size Code (inch)>	Rated Voltage (Vdc)	Capacitance Range
 GCM	GCM03	0.6 X 0.3 <0201>	50	1.0pF to 100pF
			25	1.0pF to 100pF
	GCM15	1.0 X 0.5 <0402>	50	1.0pF to 1000pF
	GCM18	1.6 X 0.8 <0603>	100	1.0pF to 10000pF
			80	1800pF to 3900pF
			50	1000pF to 10000pF
	GCM21	2.0 X 1.25 <0805>	630	10pF to 2200pF
			250	10pF to 10000pF
			100	1000pF to 3300pF
			80	4700pF to 22000pF
			50	12000pF to 22000pF
	GCM31	3.2 X 1.6 <1206>	1000	10pF to 1000pF
			630	10pF to 4700pF
			250	6800pF to 22000pF
			100	3900pF to 0.10μF
			80	27000pF to 33000pF
	GCM32	3.2 X 2.5 <1210>	50	68000pF to 0.10μF
			1000	1500pF to 2200pF
GCM43	4.5 X 3.2 <1812>	630	1500pF to 10000pF	
		1000	3300pF to 4700pF	
GCM55	5.7 X 5.0 <2220>	630	15000pF to 22000pF	
		1000	6800pF to 10000pF	
			630	33000pF to 47000pF

## Capacitors

## High Dielectric Constant Type

Series	LXW (mm) <Size Code (inch)>	Rated Voltage (Vdc)	Capacitance Range	
 GCM	GCM03	0.6 X 0.3 <0201>	25	100pF to 3300pF
		16	330pF to 3300pF	
		10	4700pF to 10000pF	
	GCM15	1.0 X 0.5 <0402>	100	220pF to 4700pF
			50	220pF to 0.10μF
			25	10000pF to 0.10μF
			16	33000pF to 0.22μF
			10	0.47μF to 1.0μF
	GCM18	1.6 X 0.8 <0603>	100	6800pF to 22000pF
			50	0.22μF
			25	0.22μF to 1.0μF
			16	0.33μF to 1.0μF
			6.3	2.2μF to 10μF
	GCM21	2.0 X 1.25 <0805>	4	10μF
			100	33000pF to 1.0μF
			50	0.22μF to 1.0μF
			35	0.68μF to 4.7μF
			25	0.33μF to 4.7μF
			16	1.0μF to 10μF
	GCM31	3.2 X 1.6 <1206>	10	2.2μF to 10μF
			6.3	10μF
			100	0.22μF to 2.2μF
			50	1.0μF to 4.7μF
			25	1.0μF to 10μF
GCM32	3.2 X 2.5 <1210>	16	4.7μF to 10μF	
		10	22μF	
		6.3	22μF	
		100	4.7μF	
		50	4.7μF to 10μF	
		35	10μF	
		25	10μF to 22μF	
16	22μF			
10	22μF to 47μF			
6.3	47μF			

## High Effective Capacitance & High Ripple Current Chip Multilayer Ceramic Capacitors for Automotive



Series	LXW (mm) <Size Code (inch)>	Rated Voltage (Vdc)	Capacitance Range
 GC3	GC321	250	10000pF to 22000pF
		630	10000pF to 15000pF
	GC331	450	10000pF to 47000pF
		250	33000pF to 68000pF
	GC332	630	22000pF to 47000pF
		450	68000pF to 0.10μF
		250	0.10μF to 0.15μF
	GC343	630	68000pF
		450	0.15μF
		250	0.22μF to 0.33μF
	GC355	630	0.10μF to 0.22μF
		450	0.22μF to 0.47μF
250		0.47μF to 1.0μF	

## Soft Termination Chip Multilayer Ceramic Capacitors for Automotive



Series	LXW (mm) <Size Code (inch)>	Rated Voltage (Vdc)	Capacitance Range
 GCJ	GCJ18	100	1000pF to 0.10μF
		50	1000pF to 0.22μF
		35	33000pF to 68000pF
		25	1000pF to 1.0μF
		16	27000pF to 0.47μF
		10	0.22μF
		6.3	2.2μF to 4.7μF
	GCJ21	250	1000pF to 22000pF
		100	27000pF to 1.0μF
		50	82000pF to 1.0μF
		35	0.12μF to 0.47μF
		25	0.12μF to 2.2μF
		16	0.27μF to 4.7μF
		10	2.2μF to 10μF
	GCJ31	1000	1000pF to 10000pF
		630	1000pF to 22000pF
		250	15000pF to 0.10μF
		100	0.15μF to 2.2μF
		50	0.47μF to 4.7μF
		35	0.56μF to 1.0μF
		25	2.2μF to 10μF
		16	3.3μF to 10μF
		10	6.8μF to 22μF
	6.3	22μF	
GCJ32	1000	15000pF to 22000pF	
	630	6800pF to 47000pF	
	250	68000pF to 0.22μF	

Capacitors

Series		LXW (mm) <Size Code (inch)>	Rated Voltage (Vdc)	Capacitance Range
 GCJ	GCJ32	3.2 X 2.5 <1210>	100	2.2µF to 4.7µF
			50	4.7µF to 10µF
			25	4.7µF to 22µF
			16	6.8µF to 22µF
			6.3	47µF
	GCJ43	4.5 X 3.2 <1812>	1000	33000pF to 47000pF
			630	33000pF to 0.10µF
			250	0.15µF to 0.47µF
	GCJ55	5.7 X 5.0 <2220>	1000	68000pF to 0.10µF
630			0.10µF to 0.22µF	
250	0.33µF to 1.0µF			

High Q Chip Multilayer Ceramic Capacitors for Automotive



Series		LXW (mm) <Size Code (inch)>	Rated Voltage (Vdc)	Capacitance Range
 GCQ	GCQ15	1.0 X 0.5 <0402>	50	0.10pF to 47pF

MLSC Design Chip Multilayer Ceramic Capacitors for Automotive



Series		LXW (mm) <Size Code (inch)>	Rated Voltage (Vdc)	Capacitance Range
 GCD	GCD18	1.6 X 0.8 <0603>	100	1000pF to 22000pF
			50	1000pF to 22000pF
			25	27000pF to 47000pF
	GCD21	2.0 X 1.25 <0805>	100	27000pF to 0.10µF
			50	27000pF to 0.10µF
			16	0.47µF

Soft Termination MLSC Design Chip Multilayer Ceramic Capacitors for Automotive



Series		LXW (mm) <Size Code (inch)>	Rated Voltage (Vdc)	Capacitance Range
 GCE	GCE18	1.6 X 0.8 <0603>	100	1000pF to 22000pF
			50	1000pF to 22000pF
			25	27000pF to 47000pF
	GCE21	2.0 X 1.25 <0805>	100	27000pF to 0.10µF
			50	27000pF to 0.10µF

### 3 Terminals Low ESL Chip Multilayer Ceramic Capacitors for Automotive



Series	LXW (mm) <Size Code (inch)>	Rated Voltage (Vdc)	Capacitance Range
 NFM	NFM18	1.6 X 0.8 <0603>	16 1.0μF
		6.3 1.0μF	
	NFM21	2.0 X 1.25 <0805>	50 220pF to 22000pF
			16 1.0μF
			10 0.10μF to 0.47μF
	NFM31	3.2 X 1.6 <1206>	100 10000pF
50 10000pF to 0.10μF			

### Metal Terminal Type Multilayer Ceramic Capacitors for Automotive

#### Temperature Compensating Type



Series	LXW (mm)	Rated Voltage (Vdc)	Capacitance Range
 KCM	KCM55	6.1 X 5.1	630 15000pF to 54000pF

#### High Dielectric Constant Type

Series	LXW (mm)	Rated Voltage (Vdc)	Capacitance Range
 KCM	KCM55	6.1 X 5.3	100 4.7μF to 22μF
			63 4.7μF to 22μF
			50 4.7μF to 33μF
			35 10μF to 47μF
			25 15μF to 100μF

### High Effective Capacitance & High Allowable Ripple Current Metal Terminal Type Multilayer Ceramic Capacitors for Automotive



Series	LXW (mm)	Rated Voltage (Vdc)	Capacitance Range
 KC3	KC355	6.1 X 5.3	630 0.10μF to 1.2μF
			450 0.22μF to 2.2μF
			250 0.47μF to 2.2μF



## Safety Standard Certified Metal Terminal Type Multilayer Ceramic Capacitors for Automotive



Series	LXW (mm)	Rated Voltage (Vdc)	Capacitance Range	
 KCA	KCA55	6.1 X 5.1	AC250 (r.m.s.)	100pF to 10000pF

## AgPd Termination Conductive Glue Mounting Chip Multilayer Ceramic Capacitors for Automotive

### Temperature Compensating Type



Series	LXW (mm) <Size Code (inch)>	Rated Voltage (Vdc)	Capacitance Range	
 GCG	GCG15	1.0 X 0.5 <0402>	50	120pF to 470pF
	GCG18	1.6 X 0.8 <0603>	100	10pF to 10000pF
			50	10pF to 2200pF
	GCG21	2.0 X 1.25 <0805>	50	1000pF to 10000pF

### High Dielectric Constant Type

Series	LXW (mm) <Size Code (inch)>	Rated Voltage (Vdc)	Capacitance Range	
 GCG	GCG15	1.0 X 0.5 <0402>	50	220pF to 4700pF
			25	5600pF to 10000pF
			16	15000pF to 0.10μF
	GCG18	1.6 X 0.8 <0603>	100	1000pF to 0.10μF
			50	1200pF to 0.22μF
			25	0.12μF to 0.47μF
			16	0.15μF to 1.0μF
			10	2.2μF
			6.3	2.2μF
			50	0.15μF to 1.0μF
	GCG21	2.0 X 1.25 <0805>	35	0.68μF to 1.0μF
			25	0.27μF to 1.0μF
			16	0.33μF to 4.7μF
			10	10μF
			6.3	10μF
	GCG31	3.2 X 1.6 <1206>	50	0.22μF to 0.33μF
			25	1.2μF to 4.7μF
			16	0.68μF 4.7μF
			6.3	22μF
	GCG32	3.2 X 2.5 <1210>	50	10μF
35			10μF	
25			10μF to 22μF	
16			6.8μF to 10μF	
6.3			47μF	

## Ceramic Capacitors Lead Type for Automotive

### Leaded Multilayer Ceramic Capacitors for Automotive



#### Temperature Compensating Type

Series		LXW (mm)	Rated Voltage (Vdc)	Capacitance Range
	RCE5C	3.6 X 3.5	100	1.0pF to 1500pF
			50	1.0pF to 3900pF
		4.0 X 3.5	630	10pF to 2200pF
			250	10pF to 10000pF
			100	1800pF to 3300pF
			50	4700pF to 22000pF
		5.5 X 4.0	1000	10pF to 1000pF
			630	10pF to 4700pF
			250	10pF to 22000pF
			100	3900pF to 10000pF
			50	27000pF to 0.10μF
			630	100pF to 4700pF
	RCE7U	4.0 X 3.5	250	100pF to 4700pF
			1000	10pF to 1000pF
		5.5 X 4.0	630	10pF to 4700pF
			250	6800pF to 10000pF
		5.5 X 5.0	1000	1500pF to 2200pF
			630	6800pF to 10000pF
7.5 X 5.5	1000	3300pF to 4700pF		
	630	15000pF to 22000pF		
7.5 X 8.0	1000	6800pF to 10000pF		
	630	33000pF to 47000pF		
7.7 X 13.0	1000	20000pF		
	630	94000pF		

#### High Dielectric Constant Type

Series		LXW (mm)	Rated Voltage (Vdc)	Capacitance Range
	RCEC7	4.0 X 3.5	50	1.0μF
		5.5 X 4.0	50	4.7μF
		5.5 X 5.0	100	1.5μF to 2.2μF
			50	10μF
		5.5 X 7.5	100	4.7μF
			50	22μF
	RCER7	3.6 X 3.5	100	220pF to 22000pF
			50	220pF to 0.10μF
			25	0.10μF to 0.22μF
		4.0 X 3.5	250	1000pF to 22000pF
			100	33000pF to 0.33μF
			50	0.15μF to 0.47μF
		5.5 X 4.0	25	0.33μF to 1.0μF
			1000	1000pF to 10000pF
			630	22000pF to 22000pF
			250	33000pF to 0.10μF
			100	0.15μF to 1.0μF
			50	0.68μF to 2.2μF
25	1.5μF to 4.7μF			

## Capacitors

Series		LXW (mm)	Rated Voltage (Vdc)	Capacitance Range
 RCE	RCER7	5.5 X 5.0	1000	15000pF to 22000pF
			630	33000pF to 47000pF
			250	0.15μF to 0.22μF
			50	3.3μF to 4.7μF
			25	10μF
		5.5 X 7.5	50	10μF
			25	22μF
		7.5 X 5.5	1000	33000pF to 47000pF
			630	68000pF to 0.10μF
		7.5 X 7.5	250	0.33μF to 0.47μF
			250	0.68μF to 1.0μF
		7.5 X 8.0	1000	68000pF to 0.10μF
			630	0.15μF to 0.22μF
		7.7 X 12.5	250	2.2μF
7.7 X 13.0	1000	0.22μF		
	630	0.47μF		

## 150°C Operation Leaded Multilayer Ceramic Capacitors for Automotive

## Temperature Compensating Type



Series		LXW (mm)	Rated Voltage (Vdc)	Capacitance Range
 RHE	RHE5G	3.6 X 3.5	100	100pF to 1500pF
			50	100pF to 3900pF
		4.0 X 3.5	100	1800pF to 3300pF
			50	4700pF to 10000pF

## High Dielectric Constant Type

Series		LXW (mm)	Rated Voltage (Vdc)	Capacitance Range
 RHE	RHEL8	3.6 X 3.5	100	220pF to 22000pF
			50	220pF to 0.10μF
			25	0.10μF to 0.22μF
		4.0 X 3.5	100	33000pF to 0.10μF
			50	0.15μF to 0.33μF
			25	0.33μF to 1.0μF
		5.5 X 4.0	100	0.15μF to 0.22μF
			50	0.47μF to 2.2μF
			25	1.5μF to 4.7μF
		5.5 X 5.0	50	3.3μF to 4.7μF
			25	10μF
		5.5 X 7.5	50	10μF
			25	22μF

## 175°C/200°C Operation Leaded Multilayer Ceramic Capacitors for Automotive

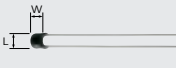

### Temperature Compensating Type

Series	LXW (mm)	Rated Voltage (Vdc)	Capacitance Range	
 RHS	RHS7G	3.9 X 3.5	100	100pF to 1500pF
		4.2 X 3.5	100	1800pF to 3300pF
	RHS7J	4.2 X 3.5	200	100pF to 4700pF
		5.5 X 4.0	500	100pF to 4700pF
		200	6800pF to 10000pF	

## Safety Standard Certified Lead Type Disc Ceramic Capacitors for Automotive



Series	Rated Voltage (Vdc)	D (mm)	Capacitance Range	
 DE6	DE6E3	X1: AC440V(r.m.s.) Y2: AC300V(r.m.s.)	7.0 to 12.0	1000pF to 4700pF

## Polymer Aluminum Electrolytic Capacitors



Series	LXW (mm)	Rated Voltage (Vdc)	Capacitance Range
 ECAS	7.3 X 4.3	25	10μF to 33μF
		20	33μF to 47μF
		16	6.8μF to 68μF
		10	10μF to 100μF
		6.3	10μF to 220μF
		4	68μF to 220μF
		2.5	330μF to 470μF
		2	100μF to 470μF

Products Lineup (High Reliability)

# Noise Suppression Products / EMI Suppression Filters

## Chip Ferrite Beads / Application Specified Noise Filters



		Part Number	Applications	Size Code inch (mm)	Impedance at 100MHz	
For General Band Noise	Universal Type [ Power Lines/Signal Lines ]	BLM03AX	<a href="#">Info-tainment</a>	0201 (0603)	10Ω to 1000Ω	
		BLM15AX	<a href="#">Info-tainment</a>	0402 (1005)	10Ω to 1000Ω	
	Signal Lines Type	For General Signal Lines	BLM03AG	<a href="#">Info-tainment</a>	0201 (0603)	10Ω to 1000Ω
			BLM15AG	<a href="#">Info-tainment</a> <a href="#">Power-train</a>	0402 (1005)	10Ω to 1000Ω
			BLM18AG	<a href="#">Info-tainment</a> <a href="#">Power-train</a>	0603 (1608)	120Ω to 1000Ω
			BLM18AG* (150°C available)	<a href="#">Power-train</a>	0603 (1608)	120Ω to 1000Ω
			BLM18AG* (Conductive glue)	<a href="#">Power-train</a>	0603 (1608)	470Ω to 1000Ω
		BLM21AG	<a href="#">Info-tainment</a> <a href="#">Power-train</a>	0805 (2012)	120Ω to 1000Ω	
		BLM21AG* (150°C available)	<a href="#">Power-train</a>	0805 (2012)	120Ω to 1000Ω	
		BLM31AJ	<a href="#">Power-train</a>	1206 (3216)	600Ω	
		For High Speed Signal Lines	BLM03B	<a href="#">Info-tainment</a>	0201 (0603)	10Ω to 600Ω
			BLM15B	<a href="#">Info-tainment</a> <a href="#">Power-train</a>	0402 (1005)	5Ω to 1800Ω
	BLM18B		<a href="#">Info-tainment</a> <a href="#">Power-train</a>	0603 (1608)	5Ω to 2500Ω	
	BLM18B* (150°C available)		<a href="#">Power-train</a>	0603 (1608)	47Ω to 2500Ω	
	BLM21B		<a href="#">Info-tainment</a> <a href="#">Power-train</a>	0805 (2012)	5Ω to 2700Ω	
	Power Lines Type	BLM03PX*	<a href="#">Info-tainment</a>	0201 (0603)	22Ω to 120Ω	
		BLM03PG	<a href="#">Info-tainment</a>	0201 (0603)	22Ω to 33Ω	
		BLM15PX*	<a href="#">Info-tainment</a>	0402 (1005)	33Ω to 600Ω	
		BLM15PG/PD*	<a href="#">Info-tainment</a>	0402 (1005)	10Ω to 120Ω	
		BLM18PG*	<a href="#">Info-tainment</a> <a href="#">Power-train</a>	0603 (1608)	30Ω to 470Ω	
		BLM21PG*	<a href="#">Info-tainment</a> <a href="#">Power-train</a>	0805 (2012)	22Ω to 330Ω	
		BLM21PG* (150°C available)	<a href="#">Power-train</a>	0805 (2012)	22Ω to 330Ω	
		BLM31PG*	<a href="#">Info-tainment</a> <a href="#">Power-train</a>	1206 (3216)	33Ω to 600Ω	
		BLM41PG*	<a href="#">Info-tainment</a> <a href="#">Power-train</a>	1806 (4516)	60Ω to 1000Ω	
		BLM18KG*	<a href="#">Info-tainment</a> <a href="#">Power-train</a>	0603 (1608)	26Ω to 1000Ω	
		BLM18KG* (150°C available)	<a href="#">Power-train</a>	0603 (1608)	26Ω to 1000Ω	
		BLM18KG* (Conductive glue)	<a href="#">Power-train</a>	0603 (1608)	26Ω to 1000Ω	
		BLM31KN*	<a href="#">Info-tainment</a> <a href="#">Power-train</a>	1206 (3216)	120Ω to 1000Ω	
		BLM31KN* (150°C available)	<a href="#">Power-train</a>	1206 (3216)	120Ω to 1000Ω	
		BLM18SG*	<a href="#">Info-tainment</a>	0603 (1608)	26Ω to 330Ω	
		BLM18SN*	<a href="#">Info-tainment</a> <a href="#">Power-train</a>	0603 (1608)	22Ω	
		BLM21SP*	<a href="#">Info-tainment</a> <a href="#">Power-train</a>	0805 (2012)	70Ω to 1000Ω	
		BLM21SP* (150°C available)	<a href="#">Power-train</a>	0805 (2012)	70Ω to 1000Ω	
		BLM21SN*	<a href="#">Info-tainment</a> <a href="#">Power-train</a>	0805 (2012)	30Ω	
		BLM31SN*	<a href="#">Info-tainment</a> <a href="#">Power-train</a>	1206 (3216)	50Ω	
	BLE18PS*	<a href="#">Info-tainment</a> <a href="#">Power-train</a>	0603 (1608)	8.5Ω		
	BLE32PN	<a href="#">Info-tainment</a> <a href="#">Power-train</a>	1210 (3225)	26Ω to 30Ω		

\*The derating of rated current is required for some items according to the operating temperature.



		Part Number	Applications	Size Code inch (mm)	Impedance at 100MHz
For GHz Band Noise	Universal Type [ Power Lines/Signal Lines ]	BLM03EB*	<a href="#">Info-tainment</a> <a href="#">Power-train</a>	0201 (0603)	25Ω to 50Ω
		BLM15EG*	<a href="#">Info-tainment</a> <a href="#">Power-train</a>	0402 (1005)	120Ω to 220Ω
		BLM18EG*	<a href="#">Info-tainment</a> <a href="#">Power-train</a>	0603 (1608)	100Ω to 600Ω
		BLM18HE*	<a href="#">Info-tainment</a> <a href="#">Power-train</a>	0603 (1608)	600Ω to 1500Ω
	Signal Lines Type	BLM03HG	<a href="#">Info-tainment</a> <a href="#">Power-train</a>	0201 (0603)	600Ω to 1200Ω
		BLM03HD	<a href="#">Info-tainment</a>	0201 (0603)	330Ω to 1800Ω
		BLM03HB	<a href="#">Info-tainment</a>	0201 (0603)	190Ω to 400Ω
		BLM15HG	<a href="#">Info-tainment</a> <a href="#">Power-train</a>	0402 (1005)	600Ω to 1000Ω
		BLM15HG* (150°C available)	<a href="#">Power-train</a>	0402 (1005)	600Ω to 1000Ω
		BLM15HD	<a href="#">Info-tainment</a> <a href="#">Power-train</a>	0402 (1005)	600Ω to 1800Ω
		BLM15HB	<a href="#">Info-tainment</a> <a href="#">Power-train</a>	0402 (1005)	120Ω to 220Ω
		BLM18HG	<a href="#">Info-tainment</a> <a href="#">Power-train</a>	0603 (1608)	470Ω to 1000Ω
		BLM18HD	<a href="#">Info-tainment</a> <a href="#">Power-train</a>	0603 (1608)	470Ω to 1000Ω
		BLM18HB	<a href="#">Info-tainment</a>	0603 (1608)	120Ω to 330Ω
For High-GHz Band Noise	Power Lines Type	BLM18DN*	<a href="#">Info-tainment</a> <a href="#">Power-train</a>	0603 (1608)	150Ω to 600Ω
	Signal Lines Type	BLM15GG	<a href="#">Info-tainment</a>	0402 (1005)	220Ω to 470Ω
		BLM15GA	<a href="#">Info-tainment</a>	0402 (1005)	75Ω
		BLM18GG	<a href="#">Info-tainment</a>	0603 (1608)	470Ω

\*The derating of rated current is required for some items according to the operating temperature.

## Application Specified Noise Filters



		Part Number	Applications	Size Code inch (mm)	Impedance at 700MHz
For 700MHz Band		BLF03JD*	<a href="#">Info-tainment</a>	0201 (0603)	420Ω

\*The derating of rated current is required for some items according to the operating temperature.



		Part Number	Applications	Size Code inch (mm)	Impedance at 1MHz
For LED Lines		NFZ32BW*	<a href="#">Info-tainment</a>	1210 (3225)	3.3Ω to 880Ω
		NFZ5BBW*	<a href="#">Info-tainment</a>	2020 (5050)	2.9Ω to 140Ω

\*The derating of rated current is required for some items according to the operating temperature.



		Part Number	Applications	Size Code inch (mm)	Impedance at 100MHz	Impedance at 10MHz
For Audio Lines		NFZ15SF	<a href="#">Info-tainment</a>	0402 (1005)	1000Ω	-
		NFZ18SM*	<a href="#">Info-tainment</a>	0603 (1608)	120Ω to 700Ω	-
		NFZ2MSD*	<a href="#">Info-tainment</a>	0806 (2016)	100Ω to 1000Ω	9Ω to 46Ω

\*The derating of rated current is required for some items according to the operating temperature.

## Noise Suppression Products / EMI Suppression Filters

### Chip EMIFIL

	Part Number	Applications	Size Code inch (mm)	Nominal Cut-off Frequency
Signal Lines Type	NFL18ZT		0603 (1608)	50MHz to 500MHz

	Part Number	Applications	Size Code inch (mm)	Capacitance
Universal Type [ Power Lines/Signal Lines ]	NFE31ZT		1206 (3216)	22pF to 2200pF
	NFE61HT		2706 (6816)	33pF to 3300pF

### Common Mode Choke Coils / Common Mode Noise Filters

	Part Number	Applications	Size Code inch (mm)	Common Mode Impedance at 100MHz
Signal Lines Type For Differential Signal Lines	DLM11S		0504 (1210)	45Ω to 90Ω
	DLW21S		0805 (2012)	67Ω to 490Ω
	DLW31S		1206 (3216)	2200Ω
Universal Type [ Power Lines/Signal Lines ]	DLW5BS		2020 (5050)	500Ω to 800Ω
	DLW5AT*/DLW5BT*		2014 (5036)/ 2020 (5050)	45Ω to 1400Ω
Power Lines Type	UCMH0907		3527 (9070)	700Ω



\*The derating of rated current is required for some items according to the operating temperature.

	Part Number	Applications	Size Code inch (mm)	Common Mode Inductance at 0.1MHz	Common Mode Inductance at 1MHz
For CAN/FlexRay	DLW32SH110XK2		1210 (3225)	11μH	-
	DLW32SH220XK2		1210 (3225)	22μH	-
	DLW43SH110XK2		1812 (4532)	11μH	-
	DLW43SH220XK2		1812 (4532)	22μH	-
	DLW43SH510XK2		1812 (4532)	-	51μH
	DLW43SH101XK2		1812 (4532)	-	100μH
	DLW43SH101XP2		1812 (4532)	100μH	-

	Part Number	Applications	Size Code inch (mm)	Common Mode Inductance at 0.1MHz
For CAN/CAN FD	DLW32SH510XK2		1210 (3225)	51μH
	DLW32SH101XK2		1210 (3225)	100μH
	DLW32SH101XF2		1210 (3225)	100μH
For In-vehicle Ethernet (100Mbps)	DLW32MH_XK2		1210 (3225)	100μH to 200μH
	DLW43MH		1812 (4532)	200μH
For In-vehicle Ethernet (1000Mbps)	DLW32MH_XT2		1210 (3225)	100μH (Typ.) at 500mV, 80μH -25% / +50% at 100mV

## Large Current Type for Automotive Available







	Part Number	Applications	Size Code inch (mm)	Common Mode Impedance at 10MHz
Power Lines Type	PLT5BP*		2020 (5050)	100Ω to 500Ω
	PLT10H*		-	45Ω to 1000Ω

\*The derating of rated current is required for some items according to the operating temperature.

## Block Type EMIFIL



		Part Number	Applications	Height (mm)	Rated Voltage (Vdc)	Rated Current (A)
Power Lines Type	SMD Type	BNX024H01*		3.5	50	20
		BNX025H01*		3.5	25	20
		BNX026H01*		3.5	50	20
		BNX027H01*		3.5	16	20
	Lead Type	BNX012H01*		8.5 max.	50	15

\*The derating of rated current is required for some items according to the operating temperature.

## EMI Suppression Filters (Lead Type)

### Leaded Multilayer Ferrite Beads



	Part Number	Applications	Height (mm)	Impedance at 100MHz
Signal Lines Type	BLL18AG		4.0 max.	120Ω to 1000Ω

### 3-Terminal Capacitor Lead Type



	Part Number	Applications	Height (mm)	Capacitance
Universal Type [ Power Lines/Signal Lines ]	DSS1		7.5 max.	22pF to 100nF

### Lead Type Capacitor with Varistor Function



	Part Number	Applications	Height (mm)	Capacitance	Varistor Voltage
Power Lines Type	VFC2		6.0 max.	100nF to 1μF	22V to 82V



Products Lineup (High Reliability)

# Inductors (Coils)

## Inductors for Power Lines







### For Power Circuits



Structure	Size Code inch (mm)	Series		Thickness (mm/max.)	Inductance Range	Rated Current Range			
Multilayer Type	0603 (1608)	LQM18PZ		LQM18PZ_CH	0.6	1μH to 2.5μH	750mA to 950mA		
				LQM18PZ_DH	0.75	2.2μH	650mA		
				LQM18PZ_FH	0.95	2.2μH	700mA		
	0805 (2012)	LQM21PZ		LQM21PZ_C0	0.55	470nH to 2.2μH	600mA to 1.1A		
				LQM21PZ_G0	1.0	470nH to 3.3μH	800mA to 1.3A		
				LQM21PZ_GC	1.0	1μH to 2.2μH	800mA to 900mA		
				LQM21PZ_GR	1.0	1μH to 4.7μH	800mA to 1.3A		
Wound Metal Alloy	0806 (2016)	DFE2016		DFE201612P_D	1.2	150nH to 2.2μH	1.7A to 6.2A		
Wound Ferrite Core		LQH2MPZ		LQH2MPZ_GR	0.95	330nH to 82μH	210mA to 2.2A		
Multilayer Type		LQM2MPZ		LQM2MPZ_G0	1.0	470nH to 4.7μH	1.1A to 1.6A		
				LQM2MPZ_JH	1.2	100nH	4A		
Wound Ferrite Core	1008 (2520)	LQH2HPZ		LQH2HPZ_DR	0.6	470nH to 22μH	270mA to 1.67A		
Multilayer Type				LQM2HPZ		LQH2HPZ_GR	1.0	470nH to 22μH	460mA to 2.9A
						LQH2HPZ_JR	1.2	470nH to 22μH	540mA to 3.5A
		LQM2HPZ_E0	0.8			560nH	1.5A		
		LQM2HPZ_G0	1.0			470nH to 4.7μH	1.1A to 1.8A		
Wound Metal Alloy		DFE2520		DFE252012P_D	1.2	330nH to 10μH	1.1A to 6A		
					LQH3NPZ_GR	1.0	470nH to 47μH	460mA to 2.82A	
Wound Ferrite Core	3mm square	LQH3NPZ		LQH3NPZ_JR	1.2	680nH to 47μH	570mA to 2.86A		
				LQH3NPZ_ME	1.5	1μH to 100μH	430mA to 3A		
Wound Metal Alloy				1210 (3225)	DFE3225		DFE322520F_D	2.0	1μH to 4.7μH
Wound Ferrite Core	LQH32PZ		LQH32PZ_N0		1.7	470nH to 120μH	200mA to 3.4A		
			LQH32PZ_NC		1.7	470nH to 22μH	650mA to 4.4A		
Wound Ferrite Core	4mm square	LQH43PZ			LQH43PZ_26	2.8	1μH to 220μH	240mA to 3.4A	
	5mm square	LQH5BPZ		LQH5BPZ_T0	2.2	470nH to 22μH	1.4A to 7.7A		
	6 to 9mm square	DEM80		DEM8045C_Z	4.5	1.5μH to 47μH	2.1A to 11.2A		

## For Power Circuits

Power  
train

Structure	Size Code inch (mm)	Series		Thickness (mm/max.)	Inductance Range	Rated Current Range	
Multilayer Type	0603 (1608)	LQM18PH		LQM18PH_FR	0.95	220nH to 4.7µH	620mA to 1.25A
	0805 (2012)	LQM21PH		LQM21PH_G0	1.0	0.47µH to 0.54µH	1.3A
				LQM21PH_GC	1.0	1.0µH to 2.2µH	800mA to 1A
Wound Metal Alloy	0806 (2016)	DFE2MCAH		DFE2MCAH_J0	1.2	0.15µH to 2.2µH	1.7A to 6.1A
	1008 (2520)	DFE2HCAH		DFE2HCAH_J0	1.2	330nH to 2.2µH	2.5A to 5.8A
Wound Ferrite Core	1210 (3225)	LQH32PH		LQH32PH_N0	1.7	470nH to 10µH	750mA to 3.4A
				LQH32PH_NC	1.7	470nH to 22µH	650mA to 4.4A
	4mm square	LQH44PH		LQH44PH_PR	1.8	1µH to 220µH	330mA to 4.3A
		LQH43PH		LQH43PH_26	2.8	1µH to 220µH	240mA to 3.4A
	5mm square	LQH5BPH		LQH5BPH_T0	2.2	0.47µH to 47µH	850mA to 7.7A

## For Choke Circuits

Info-  
tainment

Structure	Size Code inch (mm)	Series		Thickness (mm/max.)	Inductance Range	Rated Current Range	
Wound Ferrite Core	1210 (3225)	LQH32D		LQH32DZ_23	2.2	1µH to 470µH	60mA to 800mA
				LQH32DZ_53	1.7	1µH to 100µH	100mA to 1A

## For Choke Circuits



Power  
train

Structure	Size Code inch (mm)	Series		Thickness (mm/max.)	Inductance Range	Rated Current Range	
Wound Ferrite Core	1210 (3225)	LQH32C		LQH32CH_23	2.2	1µH to 22µH	250mA to 800mA
				LQH32CH_33	2.2	150nH to 10µH	450mA to 1.45A
				LQH32CH_53	1.7	1µH to 22µH	250mA to 1A
		LQW32F		LQW32FT_0H	2.5	10µH to 47µH	500mA to 700mA

## RF Inductors



### For RF Circuits

Info-  
tabment

Structure	Size Code inch (mm)	Series		Thickness (mm/max.)	Inductance Range	Rated Current Range	
Wound Non-magnetic Type	0402 (1005)	LQW15A		LQW15AN_0Z	0.6	1.5nH to 120nH	110mA to 1A
				LQW15AN_1Z	0.6	1.3nH to 8.4nH	640mA to 1.2A
				LQW15AN_8Z	0.6	1.3nH to 75nH	320mA to 3.15A
	0603 (1608)	LQW18A		LQW18AN_0Z	1.0	2.2nH to 470nH	75mA to 850mA
				LQW18AN_1Z	1.0	2.2nH to 33nH	550mA to 1.4A
				LQW18AN_8Z	1.0	2.2nH to 390nH	190mA to 3.2A
LQW18AS_0Z	1.0	1.6nH to 390nH	100mA to 700mA				
Film Type	0201 (0603)	LQP03T		LQP03TN_ZZ	0.33	0.6nH to 120nH	80mA to 850mA
Multilayer Type	0402 (1005)	LQG15H		LQG15HZ_02	0.55	1nH to 270nH	110mA to 1A
		LQG15W		LQG15WZ_02	0.6	0.7nH to 150nH	110mA to 1.2A



### For RF Circuits

Power-  
train

Structure	Size Code inch (mm)	Series		Thickness (mm/max.)	Inductance Range	Rated Current Range	
Multilayer Type	0402 (1005)	LQG15H		LQG15HH_02	0.55	1nH to 270nH	110mA to 1A
		LQG15W		LQG15WH_02	0.6	0.7nH to 150nH	110mA to 1.2A
	0603 (1608)	LQG18H		LQG18HH_00	0.95	1.2nH to 270nH	200mA to 1.1A



### For Choke / Tuner Circuits

Info-  
tabment

Structure	Size Code inch (mm)	Series		Thickness (mm/max.)	Inductance Range	Rated Current Range	
Wound Ferrite Core Type	0402 (1005)	LQW15C		LQW15CN_0Z	0.6	18nH to 200nH	390mA to 1.4A
				LQW15CN_1Z	0.6	20nH to 560nH	300mA to 2.2A
	0603 (1608)	LQW18C		LQW18CN_0Z	0.95	4.9nH to 650nH	430mA to 2.6A
	1206 (3216)	LQH31H		LQH31HZ_03	2.0	54nH to 880nH	180mA to 920mA

### General Purpose

Info-  
tabment

Structure	Size Code inch (mm)	Series		Thickness (mm/max.)	Inductance Range	Rated Current Range	
Wound Ferrite Core Type	1210 (3225)	LQH32NZ		LQH32NZ_23	2.2	1μH to 470μH	45mA to 445mA
	4mm square	LQH43NZ		LQH43NZ_03	2.8	1μH to 2.4mH	25mA to 500mA
2in1 Type	10mm square and over	HEAWS		HEAWS	10.0	3.3μH to 10μH	5A to 8A

Products Lineup (High Reliability)

# Timing Devices

## Crystal Units

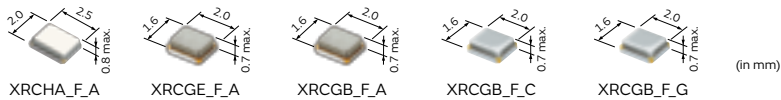

Series	Type	Frequency Range (MHz)	Frequency Tolerance (ppm)	Frequency Shift by Temperature (ppm max.)	Operating Temperature Range (°C)
XRCHA_F_A	HCR2520	16.0000 to 24.0000	±100	±100	-40 to +125
XRCGE_F_A	HCR2016	20.0000 to 23.9999	±30	±45	-40 to +125
		24.5454 to 27.6000	±15	±35	-40 to +125
XRCGB_F_A	HCR2016	24.0000 to 29.9999	±30	±35	-40 to +125
		30.0000 to 48.0000	±50	±65	-40 to +125
XRCGB_F_C	HCR2016	27.6000	±20	±20	-30 to +85
XRCGB_F_G*	HCR2016	24.0000 to 48.0000	±30,±45,±100	±50	-40 to +85

\*Only for infotainment.

## Ceramic Resonators CERALOCK

### MHz Chip Type for Automotive (Tight Frequency Tolerance)

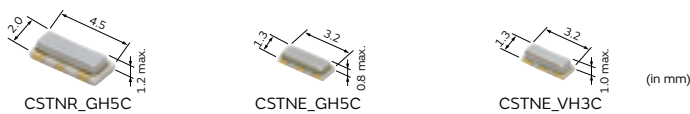

Series	Frequency Range (MHz)	Frequency Tolerance (%)	Frequency Shift by Temperature (% max.)	Operating Temperature Range (°C)
CSTNR_GH5C	4.00 to 7.99	±0.07	±0.13	-40 to +125
CSTNE_GH5C	8.00 to 13.99	±0.07	±0.13	-40 to +125
CSTNE_VH3C	14.00 to 20.00	±0.07	±0.13	-40 to +125

### MHz Chip Type for Automotive (Standard Frequency Tolerance)

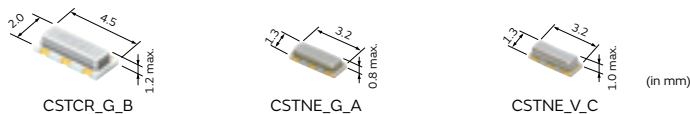

Series	Frequency Range (MHz)	Frequency Tolerance (%)	Frequency Shift by Temperature (% max.)	Operating Temperature Range (°C)
CSTCR_G_B	4.00 to 7.99	±0.5	±0.15	-40 to +125
CSTNE_G_A	8.00 to 13.99	±0.5	±0.20	-40 to +125
CSTNE_V_C	14.00 to 20.00	±0.5	±0.15	-40 to +125

Products Lineup (High Reliability)

# Filters

## Ceramic Filters CERAFIL

### Chip Type

Small and lightweight filters for IF in communications or AV equipment using unique piezoelectric material.

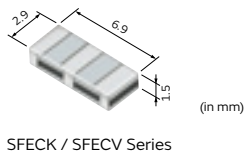

Type	Series	3dB Bandwidth (kHz)		
		E	J	K
		330	150	110
High-reliability Type	SFECK10M7□	-	●	●
Standard Type	SFECV10M7□	-	●	●
Standard Type	SFECV15M0□	●	-	-

□ is filled with the letter designating the required 3dB bandwidth.

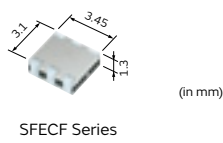

Type	Series	3dB Bandwidth (kHz)				
		D	E	F	G	H
		350	330	280	230	180
Standard Type	SFECF10M7□	●	●	●	●	●

□ is filled with the letter designating the required 3dB bandwidth.

## Ceramic Discriminators

In combination with ICs, this type obtains stable demodulation characteristics in a wide bandwidth.

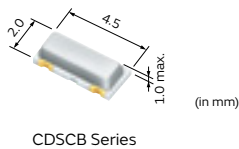

Series	Center Frequency
CDSCB	10.700MHz±30kHz

The recommended part number depends on IC specifications. Please contact us with the IC part number to be applied.

Products Lineup (High Reliability)

# Sound Components (Buzzer)

## SMD Piezoelectric Sounders

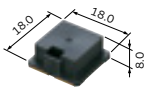

PKMCS1818E20

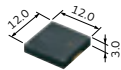

PKLCS1212E20

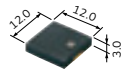

PKLCS1212E24

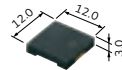

PKLCS1212E40

(in mm)

Applications	Mounting Type	Drive Type	Part Number	Sound Pressure Level (typ.)	Measurement Condition of Sound Pressure Level
For Automotive	Surface Mounting Type	External Drive	PKMCS1818E20A0-R1	100dB	12Vo-p, 2.0kHz, square wave, 10cm
			PKLCS1212E20A0-R1	76dB	±1.5Vo-p, 2.0kHz, square wave, 10cm
			PKLCS1212E24A0-R1	80dB	±1.5Vo-p, 2.4kHz, square wave, 10cm
			PKLCS1212E40A1-R1	84dB	±1.5Vo-p, 4.0kHz, square wave, 10cm

## Products Lineup (High Reliability)

# Thermistors

## NTC thermistors



### Chip Type

Chip NTC thermistors have Ni barrier terminations, provide excellent solderability, and offer high stability in harsh environments due to their unique inner construction.

Series	Resistance (25°C) (kΩ)	B-Constant (25-50°C) (K)	Operating Temperature Range (°C)
 NCU	10 to 470	3380 to 4500	-40 to +150

### Lead Type

This lead NTC thermistor is self-standing and features a flexible design and high lead strength.

Series	Resistance (25°C) (kΩ)	B-Constant (25-50°C) (K)	Operating Temperature Range (°C)
 NXFS	2 to 100	3500 to 4250	-40 to +125
 NXRS	2 to 100	3500 to 4250	-40 to +125

### PTC Thermistors (POSISTOR) Chip Type

For overheat sensing for power transistors, power diodes, and power ICs in hybrid circuits.

Series	Sensing Temperature (at 4.7kΩ) (°C)	Maximum Voltage (V)	Operating Temperature Range (°C)
 PRF	+65 to +145*	32	-40 to +150

\*The lineup includes nine models for use in different temperature ranges at 10°C intervals. Detection accuracy: ±5°C (±3°C model available)

Overcurrent Protection device with resettable function suitable for current-limiting resistors.

Series	Resistance (25°C) (Ω)	Maximum Voltage (V)	Operating Temperature Range (°C)
 PRG	2.2 to 42	16 to 30	-40 to +105

### PTC Thermistors (POSISTOR) Lead Type

Best suited to meet the requirements of power supplies and motor protection. Error-free operation is ensured by rush current.

Series	Resistance Value Tolerance (%)	Operating Temperature Range (°C)	Maximum Voltage (V)
 PTGLCS	±10	-40 to +125	16 to 140

# Global Locations

For details please visit [www.murata.com](http://www.murata.com)



## ⚠ Note

### 1 Export Control

#### For customers outside Japan:

No Murata products should be used or sold, through any channels, for use in the design, development, production, utilization, maintenance or operation of, or otherwise contribution to (1) any weapons (Weapons of Mass Destruction [nuclear, chemical or biological weapons or missiles] or conventional weapons) or (2) goods or systems specially designed or intended for military end-use or utilization by military end-users.

#### For customers in Japan:

For products which are controlled items subject to the "Foreign Exchange and Foreign Trade Law" of Japan, the export license specified by the law is required for export.

2 Please contact our sales representatives or product engineers before using the products in this catalog for the applications listed below, which require especially high reliability for the prevention of defects which might directly damage a third party's life, body or property, or when one of our products is intended for use in applications other than those specified in this catalog.

- ① Aircraft equipment
- ② Aerospace equipment
- ③ Undersea equipment
- ④ Power plant equipment
- ⑤ Medical equipment
- ⑥ Transportation equipment (vehicles, trains, ships, etc.)
- ⑦ Traffic signal equipment
- ⑧ Disaster prevention / crime prevention equipment
- ⑨ Data-processing equipment
- ⑩ Application of similar complexity and/or reliability requirements to the applications listed above

3 Product specifications in this catalog are as of March 2020. They are subject to change or our products in it may be discontinued without advance notice. Please check with our sales representatives or product engineers before ordering. If there are any questions, please contact our sales representatives or product engineers.

4 Please read rating and ⚠CAUTION (for storage, operating, rating, soldering, mounting and handling) in this catalog to prevent smoking and/or burning, etc.

5 This catalog has only typical specifications. Therefore, please approve our product specifications or transact the approval sheet for product specifications before ordering.

6 Please note that unless otherwise specified, we shall assume no responsibility whatsoever for any conflict or dispute that may occur in connection with the effect of our and/or a third party's intellectual property rights and other related rights in consideration of your use of our products and/or information described or contained in our catalogs. In this connection, no representation shall be made to the effect that any third parties are authorized to use the rights mentioned above under licenses without our consent.

7 No ozone depleting substances (ODS) under the Montreal Protocol are used in our manufacturing process.

Murata Manufacturing Co., Ltd.

[www.murata.com](http://www.murata.com)

**muRata**  
INNOVATOR IN ELECTRONICS